

Features

- Fast Read Access Time - 120 ns
- 5-Volt-Only Reprogramming
- Sector Program Operation
 - Single Cycle Reprogram (Erase and Program)
 - 2048 Sectors (256 bytes/sector)
 - Internal Address and Data Latches for 256-Bytes
- Internal Program Control and Timer
- Hardware and Software Data Protection
- Two 16 KB Boot Blocks with Lockout
- Fast Sector Program Cycle Time - 10 ms
- DATA Polling for End of Program Detection
- Low Power Dissipation
 - 40 mA Active Current
 - 100 μ A CMOS Standby Current
- Typical Endurance > 10,000 Cycles
- Single 5V \pm 10% Supply
- CMOS and TTL Compatible Inputs and Outputs

Description

The AT29C040A is a 5-volt-only in-system Flash Programmable and Erasable Read Only Memory (PEROM). Its 4 megabits of memory is organized as 524,288 words by 8 bits. Manufactured with Atmel's advanced nonvolatile CMOS EEPROM technology, the device offers access times up to 120 ns, and a low 220 mW power dissipation. When the device is deselected, the CMOS standby current is less than 100 μ A. The device endurance is such that any sector can typically be written to in excess of 10,000 times. The programming algorithm is compatible with other devices in Atmel's 5-volt-only Flash family.

(continued)

**4 Megabit
(512K x 8)
5-volt Only
256-Byte Sector
CMOS Flash
Memory**

Pin Configurations

Pin Name	Function
A0 - A18	Addresses
$\overline{\text{CE}}$	Chip Enable
$\overline{\text{OE}}$	Output Enable
$\overline{\text{WE}}$	Write Enable
I/O0 - I/O7	Data Inputs/Outputs
NC	No Connect

TSOP Top View
Type 1

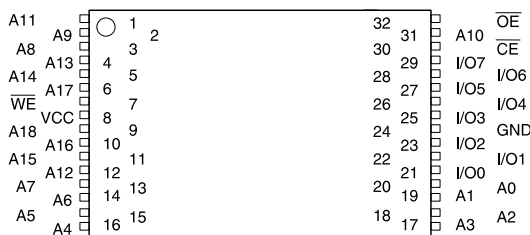

DIP Top View

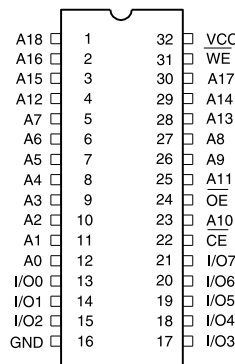

0333D



Description (Continued)

To allow for simple in-system reprogrammability, the AT29C040A does not require high input voltages for programming. Five-volt-only commands determine the operation of the device. Reading data out of the device is similar to reading from an EPROM. Reprogramming the AT29C040A is performed on a sector basis; 256-bytes of data are loaded into the device and then simultaneously programmed.

Block Diagram

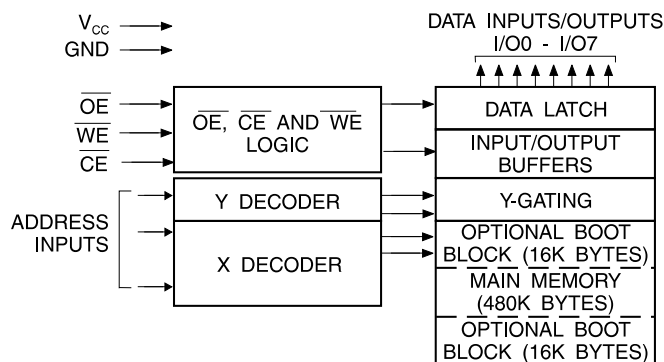

Device Operation

READ: The AT29C040A is accessed like an EPROM. When \overline{CE} and \overline{OE} are low and \overline{WE} is high, the data stored at the memory location determined by the address pins is asserted on the outputs. The outputs are put in the high impedance state whenever \overline{CE} or \overline{OE} is high. This dual-line control gives designers flexibility in preventing bus contention.

BYTE LOAD: Byte loads are used to enter the 256-bytes of a sector to be programmed or the software codes for data protection. A byte load is performed by applying a low pulse on the \overline{WE} or \overline{CE} input with \overline{CE} or \overline{WE} low (respectively) and \overline{OE} high. The address is latched on the falling edge of \overline{CE} or \overline{WE} , whichever occurs last. The data is latched by the first rising edge of \overline{CE} or \overline{WE} .

PROGRAM: The device is reprogrammed on a sector basis. If a byte of data within a sector is to be changed, data for the entire sector must be loaded into the device. Any byte that is not loaded during the programming of its sector will be erased to read FFH. Once the bytes of a sector are loaded into the device, they are simultaneously programmed during the internal programming period. After the first data byte has been loaded into the device, successive bytes are entered in the same manner. Each new byte to be programmed must have its high to low transition on \overline{WE} (or \overline{CE}) within 150 μ s of the low to high transition of \overline{WE} (or \overline{CE}) of the preceding byte. If a high to low transition is not detected within 150 μ s of the last low to high transition, the load period will end and the internal programming period will start. A8 to A18 specify the sector address. The sector address must be valid during each high to low tran-

During a reprogram cycle, the address locations and 256-bytes of data are internally latched, freeing the address and data bus for other operations. Following the initiation of a program cycle, the device will automatically erase the sector and then program the latched data using an internal control timer. The end of a program cycle can be detected by DATA polling of I/O7. Once the end of a program cycle has been detected, a new access for a read or program can begin.

sition of \overline{WE} (or \overline{CE}). A0 to A7 specify the byte address within the sector. The bytes may be loaded in any order; sequential loading is not required. Once a programming operation has been initiated, and for the duration of t_{wc} , a read operation will effectively be a polling operation.

SOFTWARE DATA PROTECTION: A software controlled data protection feature is available on the AT29C040A. Once the software protection is enabled a software algorithm must be issued to the device before a program may be performed. The software protection feature may be enabled or disabled by the user; when shipped from Atmel, the software data protection feature is disabled. To enable the software data protection, a series of three program commands to specific addresses with specific data must be performed. After the software data protection is enabled the same three program commands must begin each program cycle in order for the programs to occur. All software program commands must obey the sector program timing specifications. The SDP feature protects all sectors, not just a single sector. Once set, the software data protection feature remains active unless its disable command is issued. Power transitions will not reset the software data protection feature, however the software feature will guard against inadvertent program cycles during power transitions.

After setting SDP, any attempt to write to the device without the three-byte command sequence will start the internal write timers. No data will be written to the device; however, for the duration of t_{wc} , a read operation will effectively be a polling operation.

(continued)

Device Operation (Continued)

After the software data protection's 3-byte command code is given, a byte load is performed by applying a low pulse on the \overline{WE} or \overline{CE} input with \overline{CE} or \overline{WE} low (respectively) and \overline{OE} high. The address is latched on the falling edge of \overline{CE} or \overline{WE} , whichever occurs last. The data is latched by the first rising edge of \overline{CE} or \overline{WE} . The 256-bytes of data must be loaded into each sector by the same procedure as outlined in the program section under device operation.

HARDWARE DATA PROTECTION: Hardware features protect against inadvertent programs to the AT29C040A in the following ways: (a) V_{CC} sense—if V_{CC} is below 3.8V (typical), the program function is inhibited. (b) V_{CC} power on delay—once V_{CC} has reached the V_{CC} sense level, the device will automatically time out 5 ms (typical) before programming. (c) Program inhibit—holding any one of \overline{OE} low, \overline{CE} high or \overline{WE} high inhibits program cycles. (d) Noise filter—pulses of less than 15 ns (typical) on the \overline{WE} or \overline{CE} inputs will not initiate a program cycle.

PRODUCT IDENTIFICATION: The product identification mode identifies the device and manufacturer as Atmel. It may be accessed by hardware or software operation. The hardware operation mode can be used by an external programmer to identify the correct programming algorithm for the Atmel product. In addition, users may wish to use the software product identification mode to identify the part (i.e. using the device code), and have the system software use the appropriate sector size for program operations. In this manner, the user can have a common board design for 256K to 4-megabit densities and, with each density's sector size in a memory map, have the system software apply the appropriate sector size.

For details, see Operating Modes (for hardware operation) or Software Product Identification. The manufacturer and device code is the same for both modes.

DATA POLLING: The AT29C040A features \overline{DATA} polling to indicate the end of a program cycle. During a program cycle an attempted read of the last byte loaded will

result in the complement of the loaded data on I/O7. Once the program cycle has been completed, true data is valid on all outputs and the next cycle may begin. \overline{DATA} polling may begin at any time during the program cycle.

TOGGLE BIT: In addition to \overline{DATA} polling the AT29C040A provides another method for determining the end of a program or erase cycle. During a program or erase operation, successive attempts to read data from the device will result in I/O6 toggling between one and zero. Once the program cycle has completed, I/O6 will stop toggling and valid data will be read. Examining the toggle bit may begin at any time during a program cycle.

OPTIONAL CHIP ERASE MODE: The entire device can be erased by using a 6-byte software code. Please see Software Chip Erase application note for details.

BOOT BLOCK PROGRAMMING LOCKOUT: The AT29C040A has two designated memory blocks that have a programming lockout feature. This feature prevents programming of data in the designated block once the feature has been enabled. Each of these blocks consists of 16K bytes; the programming lockout feature can be set independently for either block. While the lockout feature does not have to be activated, it can be activated for either or both blocks.

These two 16K memory sections are referred to as *boot blocks*. Secure code which will bring up a system can be contained in a boot block. The AT29C040A blocks are located in the first 16K bytes of memory and the last 16K bytes of memory. The boot block programming lockout feature can therefore support systems that boot from the lower addresses of memory or the higher addresses. Once the programming lockout feature has been activated, the data in that block can no longer be erased or programmed; data in other memory locations can still be changed through the regular programming methods. To activate the lockout feature, a series of seven program commands to specific addresses with specific data must be performed. Please see Boot Block Lockout Feature Enable Algorithm.

If the boot block lockout feature has been activated on either block, the chip erase function will be disabled.

(continued)

Absolute Maximum Ratings*

Temperature Under Bias.....	-55°C to +125°C
Storage Temperature.....	-65°C to +150°C
All Input Voltages (including NC Pins) with Respect to Ground	-0.6V to +6.25V
All Output Voltages with Respect to Ground	-0.6V to V_{CC} + 0.6V
Voltage on \overline{OE} with Respect to Ground	-0.6V to +13.5V

*NOTICE: Stresses beyond those listed under "Absolute Maximum Ratings" may cause permanent damage to the device. This is a stress rating only and functional operation of the device at these or any other conditions beyond those indicated in the operational sections of this specification is not implied. Exposure to absolute maximum rating conditions for extended periods may affect device reliability.

Device Operation (Continued)

BOOT BLOCK LOCKOUT DETECTION: A software method is available to determine whether programming of either boot block section is locked out. See Software Product Identification Entry and Exit sections. When the device is in the software product identification mode, a read from location 00002H will show if programming the lower address boot block is locked out while reading location

FFFF2H will do so for the upper boot block. If the data is FE, the corresponding block can be programmed; if the data is FF, the program lockout feature has been activated and the corresponding block cannot be programmed. The software product identification exit mode should be used to return to standard operation.

DC and AC Operating Range

		AT29C040A-12	AT29C040A-15	AT29C040A-20
Operating Temperature (Case)	Com.	0°C - 70°C	0°C - 70°C	0°C - 70°C
	Ind.	-40°C - 85°C	-40°C - 85°C	-40°C - 85°C
V _{CC} Power Supply		5V ± 10%	5V ± 10%	5V ± 10%

Operating Modes

Mode	\overline{CE}	\overline{OE}	\overline{WE}	Ai	I/O
Read	V _{IL}	V _{IL}	V _{IH}	Ai	D _{OUT}
Program ⁽²⁾	V _{IL}	V _{IH}	V _{IL}	Ai	D _{IN}
Standby/Write Inhibit	V _{IH}	X ⁽¹⁾	X	X	High Z
Program Inhibit	X	X	V _{IH}		
Program Inhibit	X	V _{IL}	X		
Output Disable	X	V _{IH}	X		High Z
Product Identification					
Hardware	V _{IL}	V _{IL}	V _{IH}	A1 - A18 = V _{IL} , A9 = V _{IH} , ⁽³⁾ A0 = V _{IL}	Manufacturer Code ⁽⁴⁾
				A1 - A18 = V _{IL} , A9 = V _{IH} , ⁽³⁾ A0 = V _{IH}	Device Code ⁽⁴⁾
Software ⁽⁵⁾				A0 = V _{IL}	Manufacturer Code ⁽⁴⁾
				A0 = V _{IH}	Device Code ⁽⁴⁾

Notes: 1. X can be V_{IL} or V_{IH}.

2. Refer to AC Programming Waveforms.

3. V_H = 12.0V ± 0.5V.

4. Manufacturer Code: 1F, Device Code: A4

5. See details under Software Product Identification Entry/Exit.

DC Characteristics

Symbol	Parameter	Condition	Min	Max	Units
I _{LI}	Input Load Current	V _{IN} = 0V to V _{CC}		10	μA
I _{LO}	Output Leakage Current	V _{I/O} = 0V to V _{CC}		10	μA
I _{SB1}	V _{CC} Standby Current CMOS	$\overline{CE} = V_{CC} - 0.3V$ to V _{CC}	Com.	100	μA
			Ind.	300	μA
I _{SB2}	V _{CC} Standby Current TTL	$\overline{CE} = 2.0V$ to V _{CC}		3	mA
I _{CC}	V _{CC} Active Current	f = 5 MHz; I _{OUT} = 0 mA		40	mA
V _{IL}	Input Low Voltage			0.8	V
V _{IH}	Input High Voltage		2.0		V
V _{OL}	Output Low Voltage	I _{OL} = 2.1 mA		.45	V
V _{OH1}	Output High Voltage	I _{OH} = -400 μA	2.4		V
V _{OH2}	Output High Voltage CMOS	I _{OH} = -100 μA; V _{CC} = 4.5V	4.2		V

AC Read Characteristics

Symbol	Parameter	AT29C040A-12		AT29C040A-15		AT29C040A-20		Units
		Min	Max	Min	Max	Min	Max	
t_{ACC}	Address to Output Delay		120		150		200	ns
$t_{CE}^{(1)}$	\overline{CE} to Output Delay		120		150		200	ns
$t_{OE}^{(2)}$	\overline{OE} to Output Delay	0	50	0	70	0	80	ns
$t_{DF}^{(3,4)}$	\overline{CE} or \overline{OE} to Output Float	0	30	0	40	0	50	ns
t_{OH}	Output Hold from \overline{OE} , \overline{CE} or Address, whichever occurred first	0		0		0		ns

AC Read Waveforms (1, 2, 3, 4)

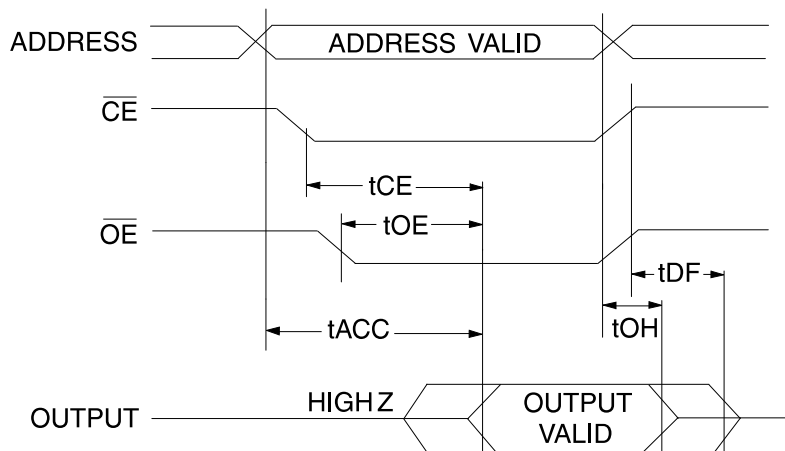

- Notes:
- \overline{CE} may be delayed up to $t_{ACC} - t_{CE}$ after the address transition without impact on t_{ACC} .
 - \overline{OE} may be delayed up to $t_{CE} - t_{OE}$ after the falling edge of \overline{CE} without impact on t_{CE} or by $t_{ACC} - t_{OE}$ after an address change without impact on t_{ACC} .
 - t_{DF} is specified from \overline{OE} or \overline{CE} whichever occurs first ($C_L = 5 \text{ pF}$).
 - This parameter is characterized and is not 100% tested.

Input Test Waveforms and Measurement Level

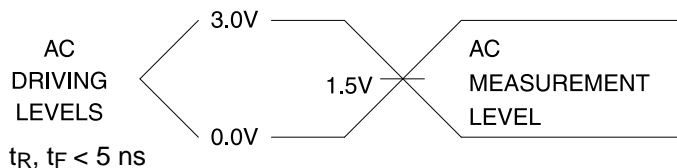

Output Test Load

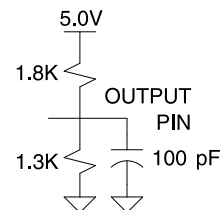

Pin Capacitance (f = 1 MHz, T = 25°C) ⁽¹⁾

	Typ	Max	Units	Conditions
C_{IN}	4	6	pF	$V_{IN} = 0V$
C_{OUT}	8	12	pF	$V_{OUT} = 0V$

Note: 1. This parameter is characterized and is not 100% tested.

AC Byte Load Characteristics

Symbol	Parameter	Min	Max	Units
t_{AS}, t_{OES}	Address, \overline{OE} Set-up Time	10		ns
t_{AH}	Address Hold Time	50		ns
t_{CS}	Chip Select Set-up Time	0		ns
t_{CH}	Chip Select Hold Time	0		ns
t_{WP}	Write Pulse Width (\overline{WE} or \overline{CE})	90		ns
t_{DS}	Data Set-up Time	50		ns
t_{DH}, t_{OEH}	Data, \overline{OE} Hold Time	10		ns
t_{WPH}	Write Pulse Width High	100		ns

AC Byte Load Waveforms ⁽¹⁾

\overline{WE} Controlled

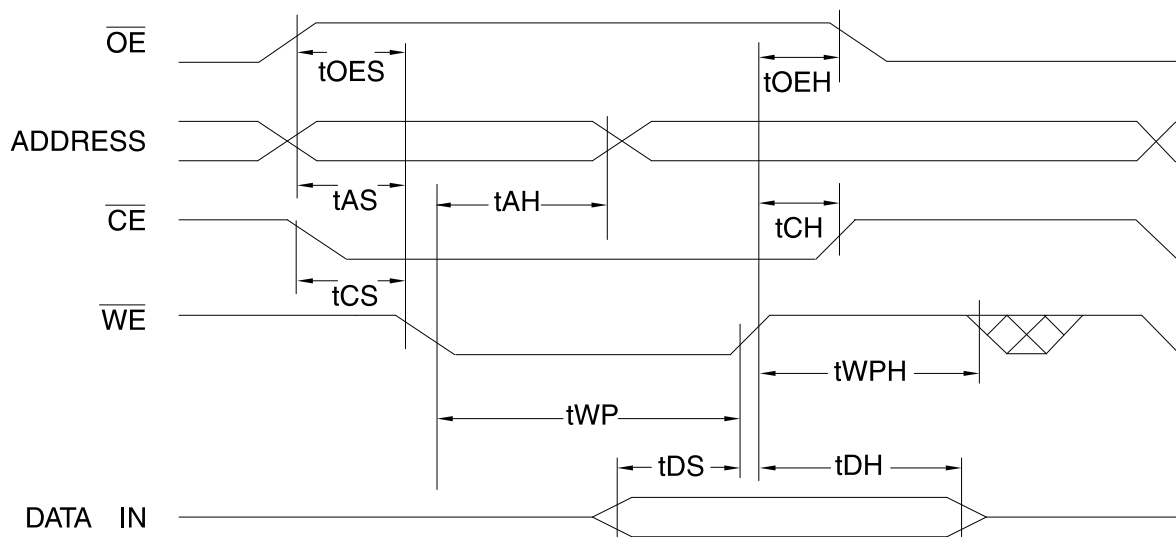

\overline{CE} Controlled

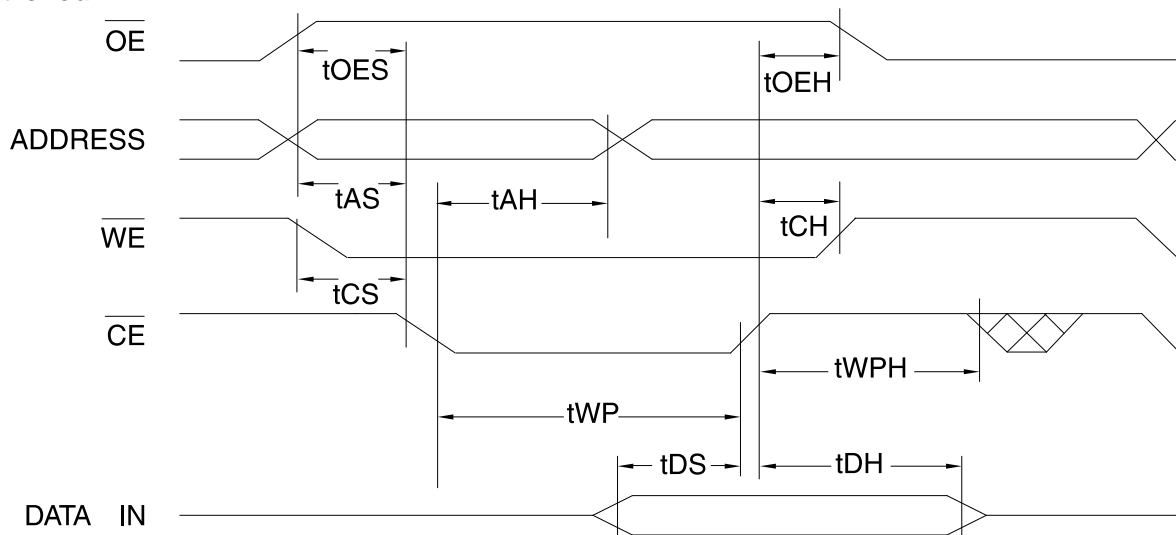

Note: 1. A complete sector (256-bytes) should be loaded using the waveforms shown in these byte load waveform diagrams.

Program Cycle Characteristics

Symbol	Parameter	Min	Max	Units
t _{WC}	Write Cycle Time		10	ms
t _{AS}	Address Set-up Time	10		ns
t _{AH}	Address Hold Time	50		ns
t _{DS}	Data Set-up Time	50		ns
t _{DH}	Data Hold Time	10		ns
t _{WP}	Write Pulse Width	90		ns
t _{BLC}	Byte Load Cycle Time		150	μs
t _{WPH}	Write Pulse Width High	100		ns

Program Cycle Waveforms ^(1, 2, 3)

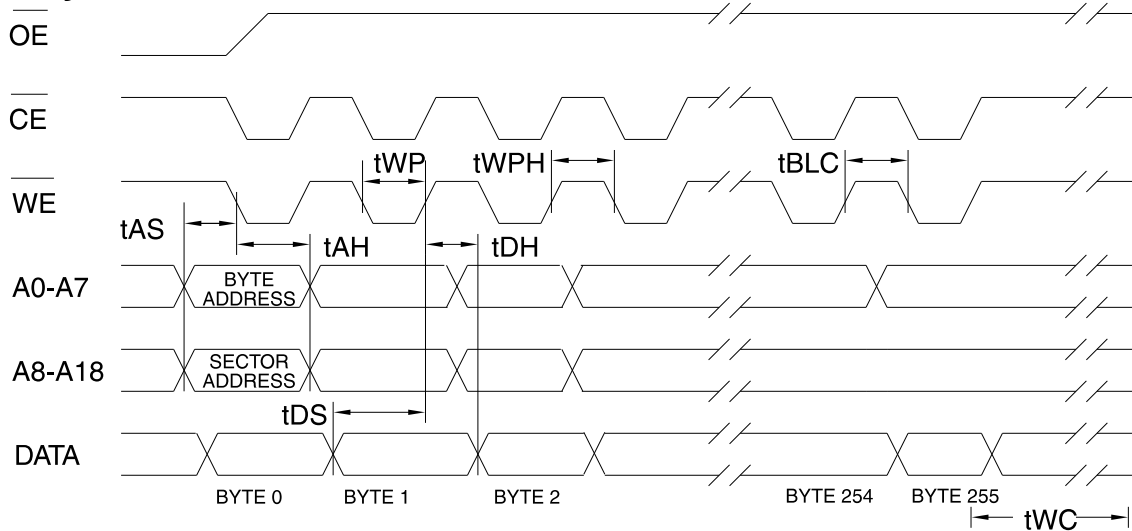

- Notes: 1. A8 through A18 must specify the sector address during each high to low transition of WE (or CE).
 2. OE must be high when WE and CE are both low.

3. All bytes that are not loaded within the sector being programmed will be indeterminate.

Software Data Protection Enable Algorithm ⁽¹⁾

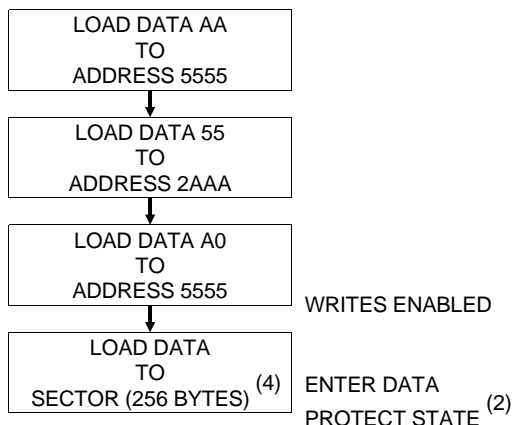

Software Data Protection Disable Algorithm ⁽¹⁾

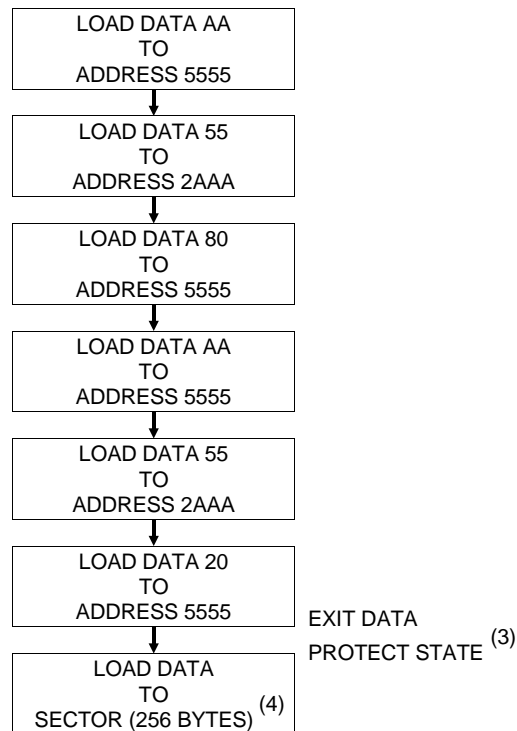

Notes for software program code:

1. Data Format: I/O7 - I/O0 (Hex);
Address Format: A14 - A0 (Hex).
2. Data Protect state will be activated at end of program cycle.
3. Data Protect state will be deactivated at end of program period.
4. 256-bytes of data **MUST BE** loaded.

Software Protected Program Cycle Waveform ^(1, 2, 3)

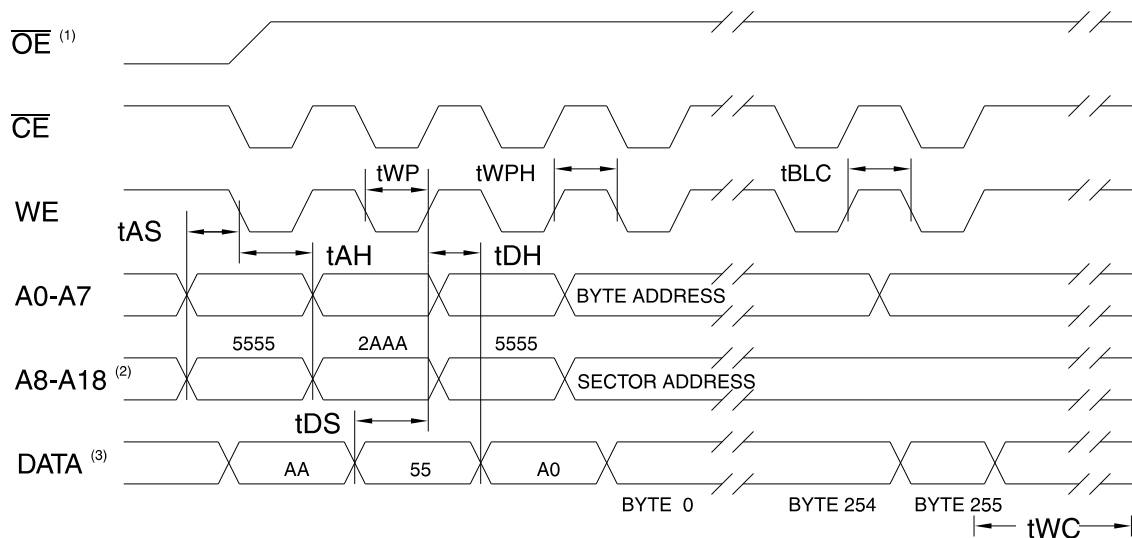

Notes: 1. A8 through A18 must specify the sector address during each high to low transition of \overline{WE} (or \overline{CE}) after the software code has been entered.

2. \overline{OE} must be high when \overline{WE} and \overline{CE} are both low.
3. **All bytes that are not loaded within the sector being programmed will be indeterminate.**

Data Polling Characteristics ⁽¹⁾

Symbol	Parameter	Min	Typ	Max	Units
t _{DH}	Data Hold Time	10			ns
t _{OE\bar{H}}	\overline{OE} Hold Time	10			ns
t _{OE}	\overline{OE} to Output Delay ⁽²⁾				ns
t _{WR}	Write Recovery Time	0			ns

Notes: 1. These parameters are characterized and not 100% tested.
 2. See t_{OE} spec in AC Read Characteristics.

Data Polling Waveforms

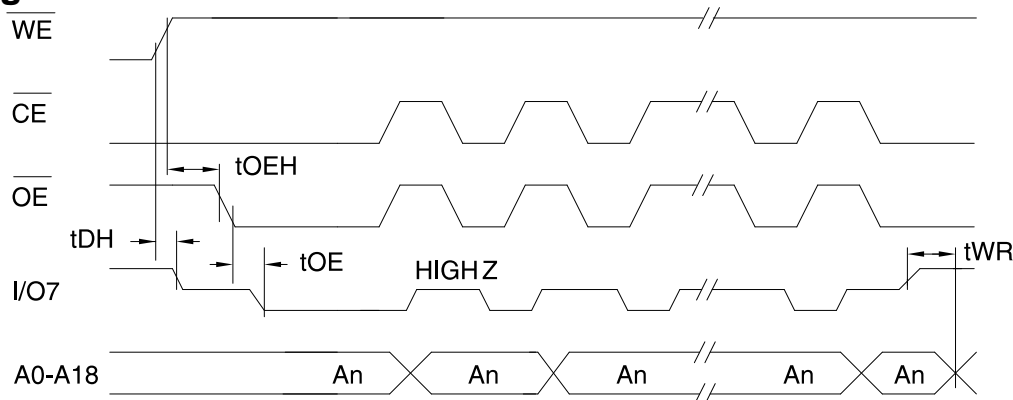

Toggle Bit Characteristics ⁽¹⁾

Symbol	Parameter	Min	Typ	Max	Units
t _{DH}	Data Hold Time	10			ns
t _{OE\bar{H}}	\overline{OE} Hold Time	10			ns
t _{OE}	\overline{OE} to Output Delay ⁽²⁾				ns
t _{OEHP}	\overline{OE} High Pulse	150			ns
t _{WR}	Write Recovery Time	0			ns

Notes: 1. These parameters are characterized and not 100% tested.
 2. See t_{OE} spec in AC Read Characteristics.

Toggle Bit Waveforms ^(1, 2, 3)

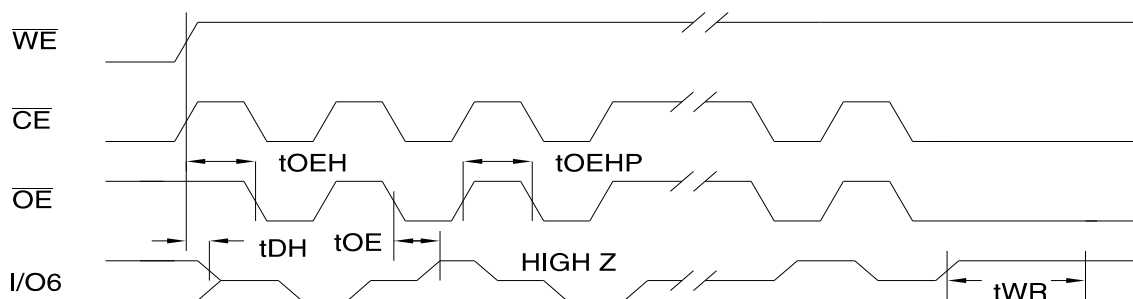

Notes: 1. Toggling either \overline{OE} or \overline{CE} or both \overline{OE} and \overline{CE} will operate toggle bit. The t_{OEHP} specification must be met by the toggling input(s).
 2. Beginning and ending state of I/O6 will vary.
 3. Any address location may be used but the address should not vary.

Software Product Identification Entry ⁽¹⁾

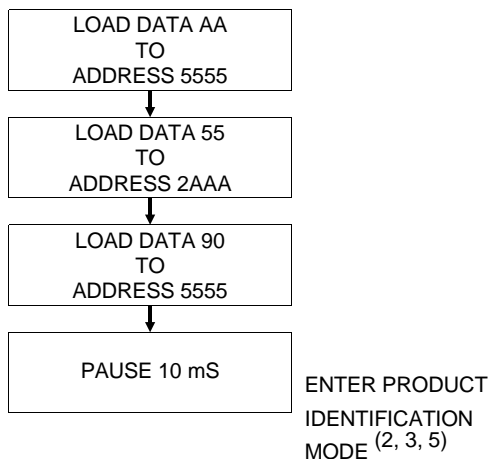

Software Product Identification Exit ⁽¹⁾

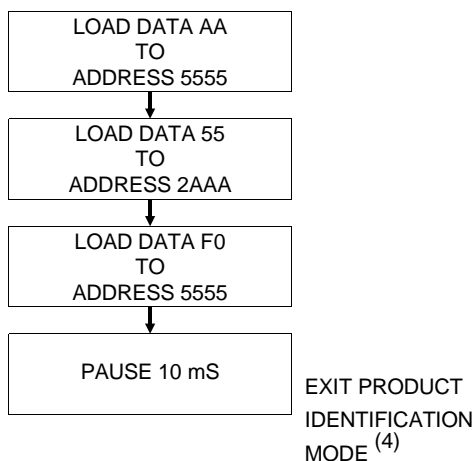

Notes for software product identification:

1. Data Format: I/O7 - I/O0 (Hex);
Address Format: A14 - A0 (Hex).
2. A1 - A18 = V_{IL}.
Manufacture Code is read for A0 = V_{IL};
Device Code is read for A0 = V_{IH}.
3. The device does not remain in identification mode if powered down.
4. The device returns to standard operation mode.
5. Manufacturer Code: 1F
Device Code: A4

Boot Block Lockout Feature Enable Algorithm ⁽¹⁾

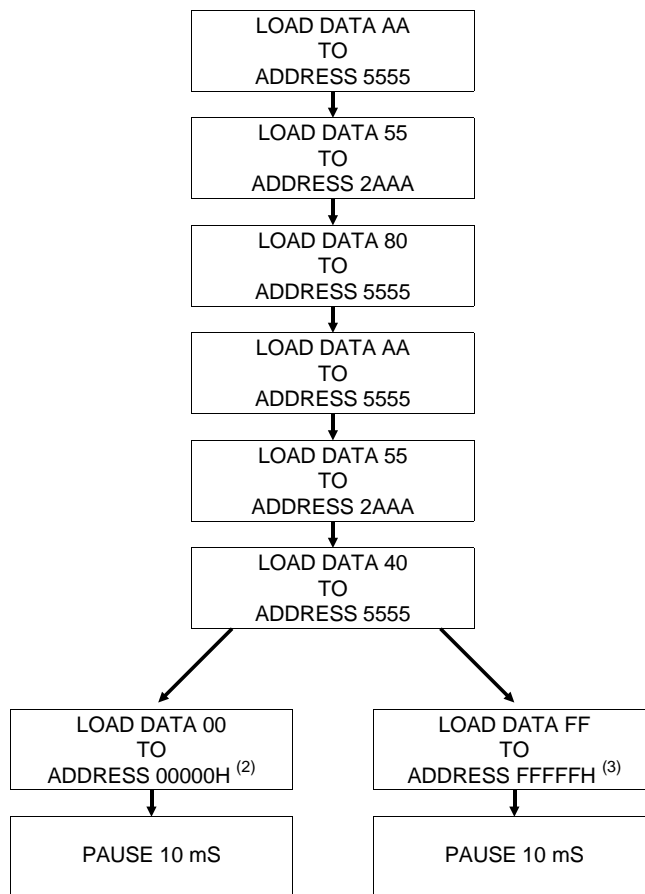

Notes for boot block lockout feature enable:

1. Data Format: I/O7 - I/O0 (Hex);
Address Format: A14 - A0 (Hex).
2. Lockout feature set on lower address boot block.
3. Lockout feature set on higher address boot block.

Ordering Information

t _{ACC} (ns)	I _{CC} (mA)		Ordering Code	Package	Operation Range
	Active	Standby			
120	40	0.1	AT29C040A-12PC AT29C040A-12TC	32P6 32T	Commercial (0° to 70°C)
	40	0.3	AT29C040A-12PI AT29C040A-12TI	32P6 32T	Industrial (-40° to 85°C)
150	40	0.1	AT29C040A-15PC AT29C040A-15TC	32P6 32T	Commercial (0° to 70°C)
	40	0.3	AT29C040A-15PI AT29C040A-15TI	32P6 32T	Industrial (-40° to 85°C)
200	40	0.1	AT29C040A-20PC	32P6	Commercial (0° to 70°C)
	40	0.3	AT29C040A-20PI	32P6	Industrial (-40° to 85°C)

Package Type	
32P6	32 Lead, 0.600" Wide, Plastic Dual Inline Package (PDIP)
32T	32 Lead, Thin Small Outline Package (TSOP)