

MITSUBISHI RF POWER TRANSISTOR 2SC2904

NPN EPITAXIAL PLANAR TYPE

DISCRIPTION

2SC2904 is a silicon NPN epitaxial planar type transistor specifically designed for high power amplifiers in HF band.

FEATURES

- High gain: $G_{pe} \geq 11.5\text{dB}$
@ $V_{CC} = 12.5\text{V}$, $P_o = 100\text{W}$, $f = 30\text{MHz}$
- High ruggedness: Ability to withstand 20:1 load VSWR when operated at $f = 30\text{MHz}$
 $P_o = 100\text{W}$, $V_{CC} = 15.2\text{V}$
- Emitter ballansted construction
- Low thermal resistance ceramic package with flange.

APPLICATION

Output stage of transmitter in HF band SSB mobile radio sets.

OUTLINE DRAWING

Dimensions in mm

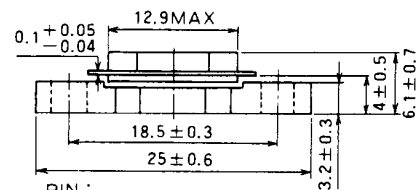
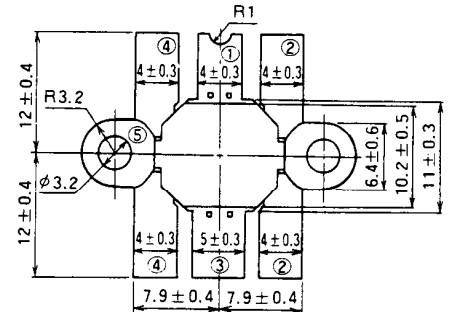

PIN :

- ① COLLECTOR
- ② EMITTER
- ③ BASE
- ④ EMITTER
- ⑤ FIN

NOTE: ALL ELECTRODES ARE ISOLATED FROM FLANGE.

T-40

ABSOLUTE MAXIMUM RATINGS ($T_C = 25^\circ\text{C}$ unless otherwise specified)

Symbol	Parameter	Conditions	Ratings	Unit
V_{CBO}	Collector to base voltage		50	V
V_{EBO}	Emitter to base voltage		5	V
V_{CEO}	Collector to emitter voltage	$R_{BE} = \infty$	20	V
I_C	Collector current		22	A
P_C	Collector dissipation	$T_a = 25^\circ\text{C}$	7.8	W
		$T_C = 25^\circ\text{C}$	200	W
T_j	Junction temperature		175	$^\circ\text{C}$
T_{stg}	Storage temperature		-55 to 175	$^\circ\text{C}$
R_{th-c}	Thermal resistance		0.75	$^\circ\text{C/W}$

Note. Above parameters are guaranteed independently.

ELECTRICAL CHARACTERISTICS ($T_C = 25^\circ\text{C}$ unless otherwise specified)

Symbol	Parameter	Test conditions	Limits			Unit
			Min	Typ	Max	
$V_{(BR)EBO}$	Emitter to base breakdown voltage	$I_E = 20\text{mA}$, $I_C = 0$	5			V
$V_{(BR)CBO}$	Collector to base breakdown voltage	$I_C = 20\text{mA}$, $I_E = 0$	50			V
$V_{(BR)CEO}$	Collector to emitter breakdown voltage	$I_C = 100\text{mA}$, $R_{BE} = \infty$	20			V
I_{CBO}	Collector cutoff current	$V_{CB} = 15\text{V}$, $I_E = 0$			5	mA
I_{EBO}	Emitter cutoff current	$V_{EB} = 3\text{V}$, $I_C = 0$			5	mA
h_{FE}	DC forward current gain *	$V_{CE} = 10\text{V}$, $I_C = 1\text{A}$	10	50	180	—
P_O	Output power	$f = 30\text{MHz}$, $V_{CC} = 12.5\text{V}$, $P_{in} = 7\text{W}$	100	110		W
η_C	Collector efficiency		55	60		%

Note. * Pulse test, $P_W = 150\mu\text{s}$, duty = 5%.

Above parameters, ratings, limits and conditions are subject to change.

NOV. '97

NPN EPITAXIAL PLANAR TYPE

TEST CIRCUIT

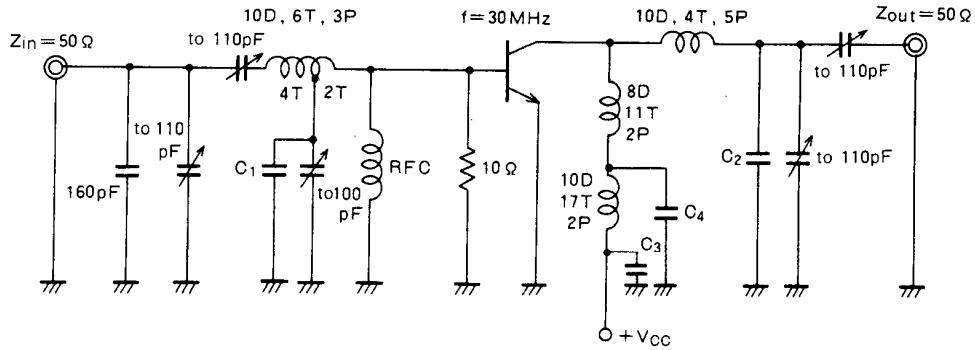

- C₁: 160pF, 160pF, 82pF in parallel
 C₂: 82pF, 82pF, 82pF in parallel
 C₃: 100pF, 4700pF, 4700pF, 0.22μF, 0.22μF, 33μF, 330μF in parallel
 C₄: 100pF, 220pF, 4700pF, 0.1μF, 330μF in parallel

NOTES: All coils but L₁ are made from 1.5mm silver plated copper wire, L₁ is made from 2.3mm copper wire.
 D: Inner diameter of coil P: Pitch of coil
 T: Turn number of coil Dimension is milli-meter

TYPICAL PERFORMANCE DATE

COLLECTOR DISSIPATION VS. AMBIENT TEMPERATURE

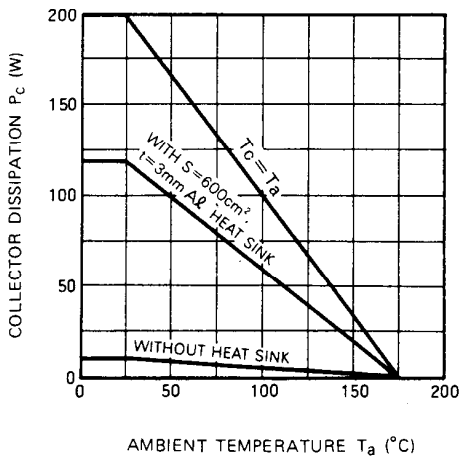

COLLECTOR CURRENT VS. COLLECTOR TO EMITTER VOLTAGE

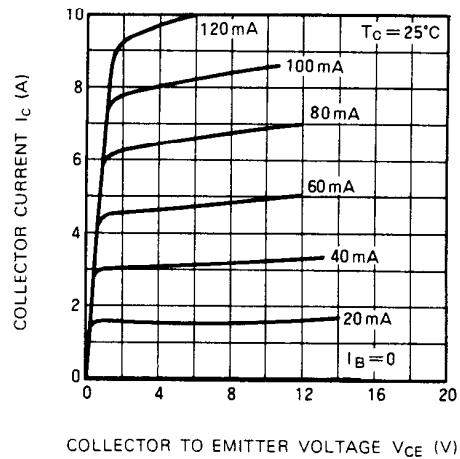

COLLECTOR TO EMITTER BREAKDOWN VOLTAGE VS. BASE TO EMITTER RESISTANCE

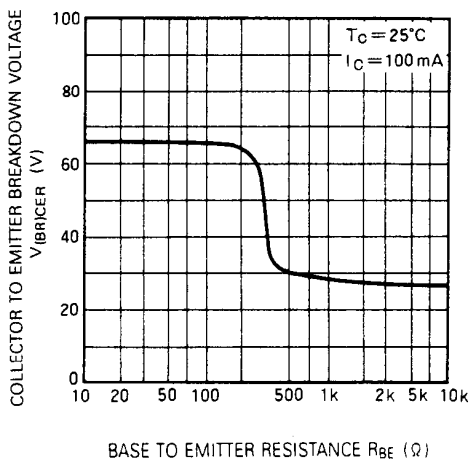

DC CURRENT GAIN VS. COLLECTOR CURRENT

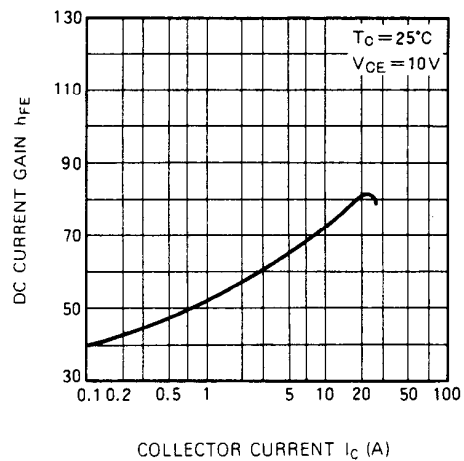

MITSUBISHI RF POWER TRANSISTOR
2SC2904

NPN EPITAXIAL PLANAR TYPE

COLLECTOR OUTPUT CAPACITANCE VS. COLLECTOR TO BASE VOLTAGE

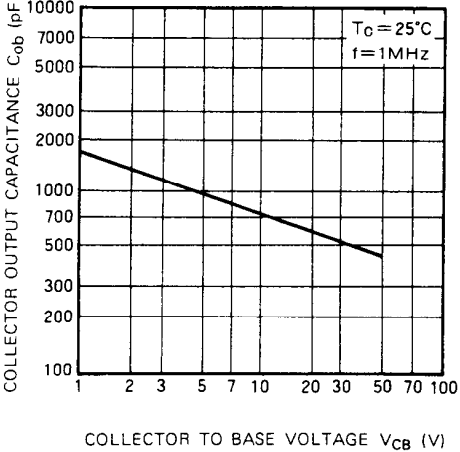

OUTPUT POWER, COLLECTOR EFFICIENCY VS. INPUT POWER

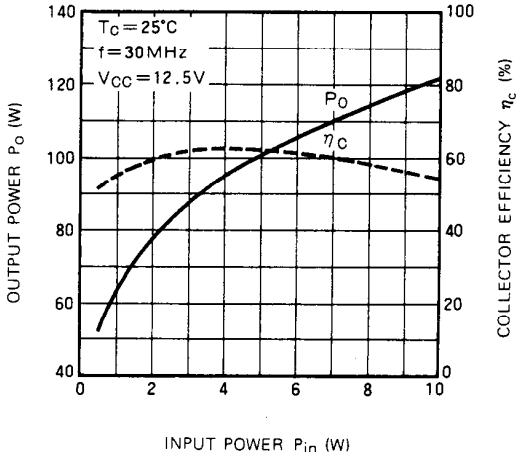

OUTPUT POWER VS. COLLECTOR SUPPLY VOLTAGE

