

High  $h_{FE}$   
Low  $V_{CE(sat)}$

# 2SC3852/3852A

Silicon NPN Epitaxial Planar Transistor

Application : Driver for Solenoid and Motor, Series Regulator and General Purpose

**Absolute maximum ratings** ( $T_a=25^\circ\text{C}$ )

Symbol	2SC3852	2SC3852A	Unit
$V_{CBO}$	80	100	V
$V_{CEO}$	60	80	V
$V_{EBO}$	6		V
$I_C$	3		A
$I_B$	1		A
$P_C$	25 ( $T_C=25^\circ\text{C}$ )		W
$T_j$	150		$^\circ\text{C}$
$T_{stg}$	-55 to +150		$^\circ\text{C}$

**Electrical Characteristics** ( $T_a=25^\circ\text{C}$ )

Symbol	Conditions	2SC3852	2SC3852A	Unit
$I_{CBO}$	$V_{CB} =$	10max		$\mu\text{A}$
$I_{EBO}$	$V_{EB} = 6\text{V}$	100max		$\mu\text{A}$
$V_{(BR)CEO}$	$I_C = 25\text{mA}$	60min	80min	V
$h_{FE}$	$V_{CE} = 4\text{V}, I_C = 0.5\text{A}$	500min		
$V_{CE(sat)}$	$I_C = 2\text{A}, I_B = 50\text{mA}$	0.5max		V
$f_T$	$V_{CE} = 12\text{V}, I_E = -0.2\text{A}$	15typ		MHz
$C_{OB}$	$V_{CB} = 10\text{V}, f = 1\text{MHz}$	50typ		pF

**External Dimensions FM20(TO220F)**

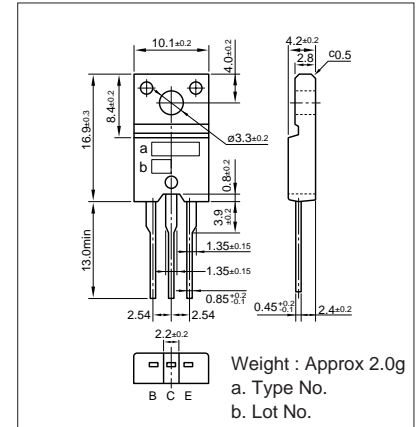

**Typical Switching Characteristics (Common Emitter)**

$V_{CC}$ (V)	$R_L$ ( $\Omega$ )	$I_C$ (A)	$V_{BB1}$ (V)	$V_{BB2}$ (V)	$I_{B1}$ (mA)	$I_{B2}$ (mA)	$t_{on}$ ( $\mu\text{s}$ )	$t_{stg}$ ( $\mu\text{s}$ )	$t_f$ ( $\mu\text{s}$ )
20	20	1.0	10	-5	15	-30	0.8typ	3.0typ	1.2typ

**$I_C - V_{CE}$  Characteristics (Typical)**

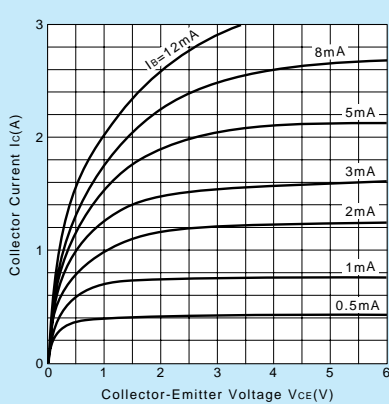

**$V_{CE(sat)} - I_B$  Characteristics (Typical)**

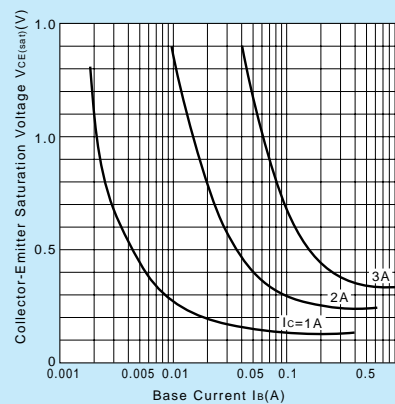

**$I_C - V_{BE}$  Temperature Characteristics (Typical)**

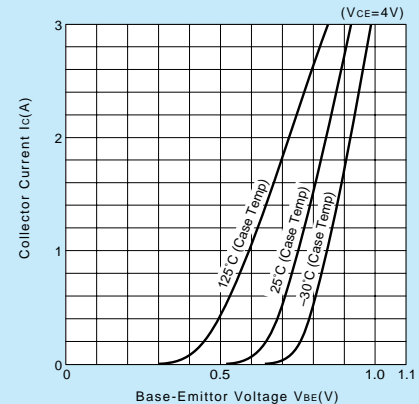

**$h_{FE} - I_C$  Characteristics (Typical)**

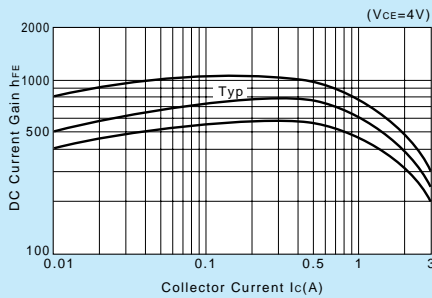

**$h_{FE} - I_C$  Temperature Characteristics (Typical)**

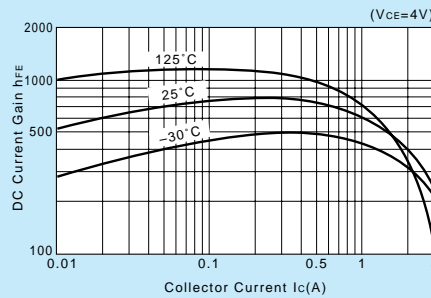

**$\theta_{j-a-t}$  Characteristics**

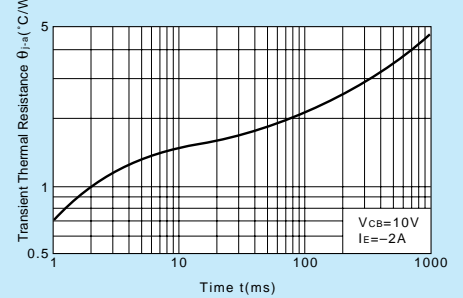

**$f_T - I_E$  Characteristics (Typical)**

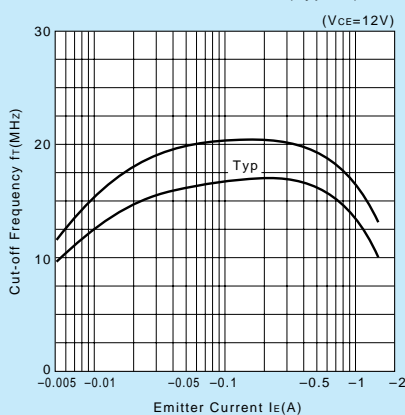

**Safe Operating Area (Single Pulse)**

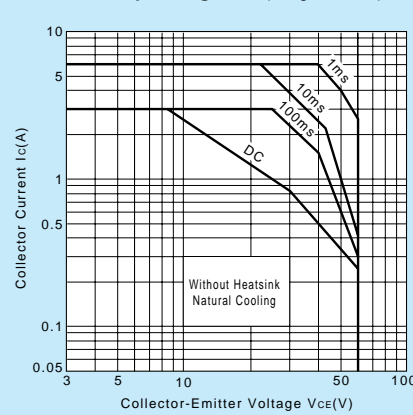

**$P_C - T_a$  Derating**

