

Built-in Avalanche Diode for Surge Absorbing Darlington

2SD1796

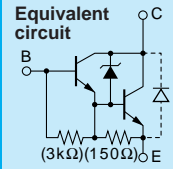

Silicon NPN Triple Diffused Planar Transistor

Application : Driver for Solenoid, Relay and Motor and General Purpose

Absolute maximum ratings (Ta=25°C)

Symbol	2SD1796	Unit
V _{CB0}	60±10	V
V _{CEO}	60±10	V
V _{EBO}	6	V
I _C	4	A
I _B	0.5	A
P _C	25(T _C =25°C)	W
T _J	150	°C
T _{stg}	-55 to +150	°C

Electrical Characteristics (Ta=25°C)

Symbol	Conditions	2SD1796	Unit
I _{CB0}	V _{CB} =50V	10max	μA
I _{EBO}	V _{EB} =6V	10max	mA
V _{(BR)CEO}	I _C =10mA	60±10	V
h _{FE}	V _{CE} =4V, I _C =3A	2000min	
V _{CE(sat)}	I _C =3A, I _B =10mA	1.5max	V
f _T	V _{CE} =12V, I _E =-0.2A	60typ	MHz
COB	V _{CB} =10V, f=1MHz	45 typ	pF

External Dimensions FM20(TO220F)

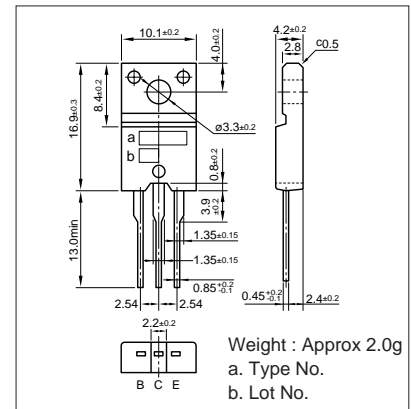

Typical Switching Characteristics (Common Emitter)

V _{CC} (V)	R _L (Ω)	I _C (A)	V _{BB1} (V)	V _{BB2} (V)	I _{B1} (mA)	I _{B2} (mA)	t _{on} (μs)	t _{stg} (μs)	t _f (μs)
30	10	3	10	-5	10	-10	1.0typ	4.0typ	1.5typ

I_C-V_{CE} Characteristics (Typical)

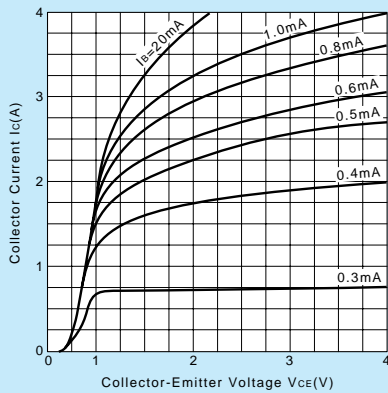

V_{CE(sat)}-I_B Characteristics (Typical)

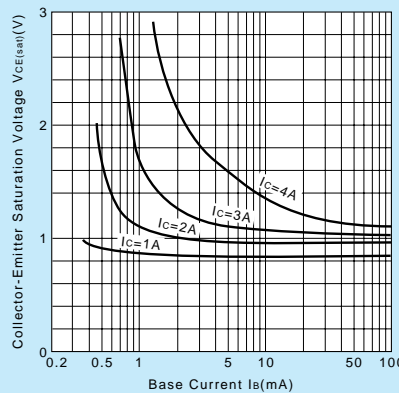

I_C-V_{BE} Temperature Characteristics (Typical)

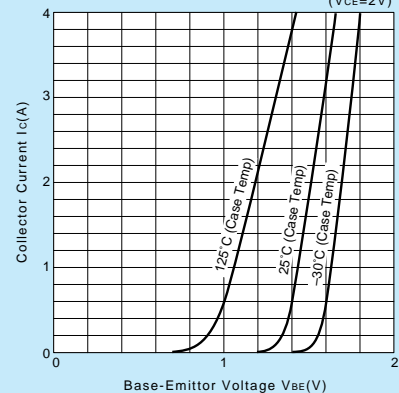

h_{FE}-I_C Characteristics (Typical)

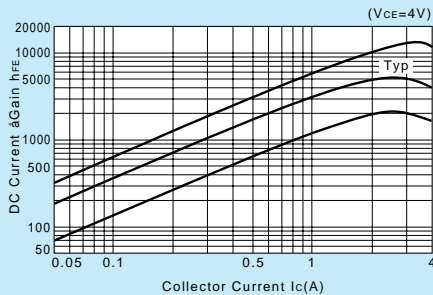

h_{FE}-I_C Temperature Characteristics (Typical)

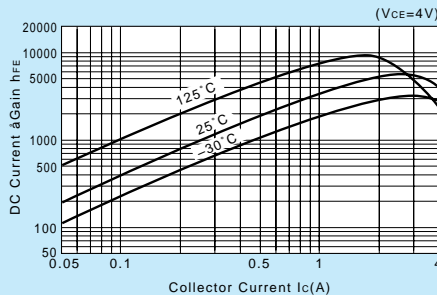

θ_{J-a}-t Characteristics

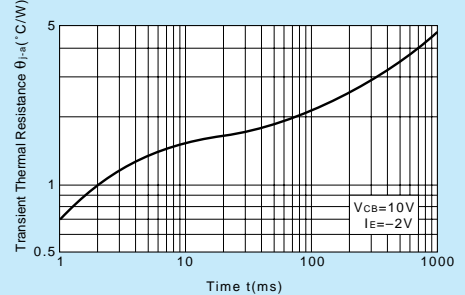

f_T-I_E Characteristics (Typical)

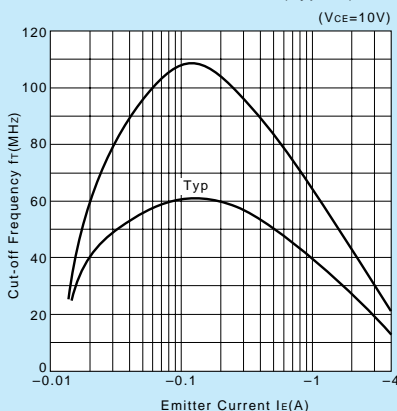

Safe Operating Area (Single Pulse)

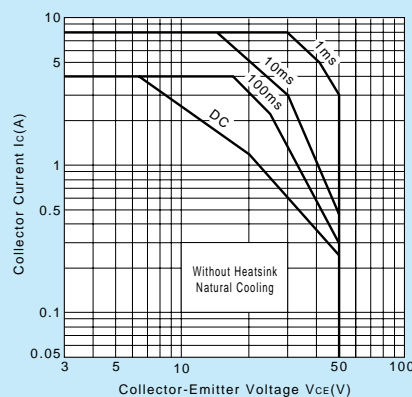

P_C-T_a Derating

