

N-CHANNEL SILICON POWER MOSFET

FAP-IIA SERIES

Features

- High speed switching
- Low on-resistance
- No secondary breakdown
- Low driving power
- High voltage
- $V_{GS}=\pm 30V$ Guarantee
- Avalanche-proof

Applications

- Switching regulators
- UPS
- DC-DC converters
- General purpose power amplifier

Maximum ratings and characteristics

Absolute maximum ratings ($T_c=25^\circ C$ unless otherwise specified)

Item	Symbol	Rating	Unit
Drain-source voltage	V_{DS}	250	V
Continuous drain current	I_D	2	A
Pulsed drain current	$I_{D(puls)}$	8	A
Continuous reverse drain current	I_{DR}	2	A
Gate-source peak voltage	V_{GS}	± 30	V
Max. power dissipation	P_D	20	W
Operating and storage temperature range	T_{ch}	+150	$^\circ C$
	T_{stg}	-55 to +150	$^\circ C$

Electrical characteristics ($T_c = 25^\circ C$ unless otherwise specified)

Item	Symbol	Test Conditions	Min.	Typ.	Max.	Units	
Drain-source breakdown voltage	$V_{(BR)DSS}$	$I_D=1mA$ $V_{GS}=0V$	250			V	
Gate threshold voltage	$V_{GS(th)}$	$I_D=1mA$ $V_{DS}=V_{GS}$	2.5	3.0	3.5	V	
Zero gate voltage drain current	I_{DSS}	$V_{DS}=250V$ $V_{GS}=0V$	$T_{ch}=25^\circ C$		10	500	μA
			$T_{ch}=125^\circ C$		0.2	1.0	mA
Gate-source leakage current	I_{GSS}	$V_{GS}=\pm 30V$ $V_{DS}=0V$		10	100	nA	
Drain-source on-state resistance	$R_{DS(on)}$	$I_D=1A$ $V_{GS}=10V$		1.2	2.0	Ω	
Forward transconductance	g_{fs}	$I_D=1A$ $V_{DS}=25V$	0.7	1.5		S	
Input capacitance	C_{iss}	$V_{DS}=25V$ $V_{GS}=0V$ $f=1MHz$		250	380	pF	
Output capacitance	C_{oss}			50	80		
Reverse transfer capacitance	C_{rss}			15	25		
Turn-on time t_{on} ($t_{on}=t_{d(on)}+t_r$)	$t_{d(on)}$	$V_{CC}=150V$ $R_G=10\Omega$ $I_D=2A$		25	40	ns	
	t_r			20	30		
Turn-off time t_{off} ($t_{off}=t_{d(off)}+t_f$)	$t_{d(off)}$	$V_{GS}=10V$		50	80		
	t_f			15	25		
Avalanche capability	I_{AV}	$L=100\mu H$ $T_{ch}=25^\circ C$	2			A	
Diode forward on-voltage	V_{SD}	$I_F=2I_{DR}$ $V_{GS}=0V$ $T_{ch}=25^\circ C$		0.9	1.4	V	
Reverse recovery time	t_{rr}	$I_F=I_{DR}$ $V_{GS}=0V$		80		ns	
Reverse recovery charge	Q_{rr}	$-di/dt=100A/\mu s$ $T_{ch}=25^\circ C$		0.2		μC	

Thermal characteristics

Item	Symbol	Test Conditions	Min.	Typ.	Max.	Units
Thermal resistance	$R_{th(ch-a)}$	channel to ambient			75.0	$^\circ C/W$
	$R_{th(ch-c)}$	channel to case			6.25	$^\circ C/W$

Outline Drawings

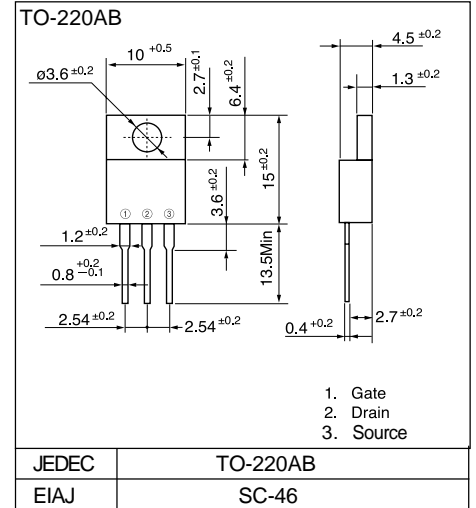

Equivalent circuit schematic

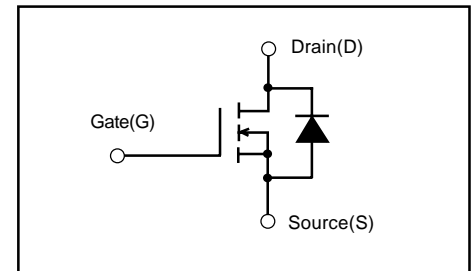

Characteristics

Typical output characteristics

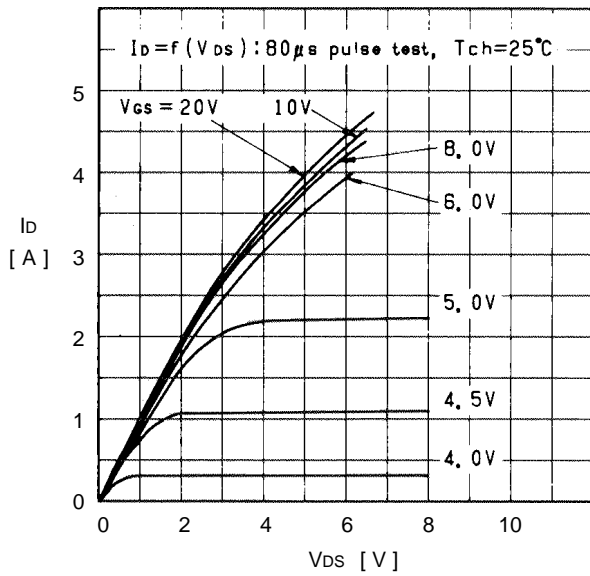

On state resistance vs. T_{ch}

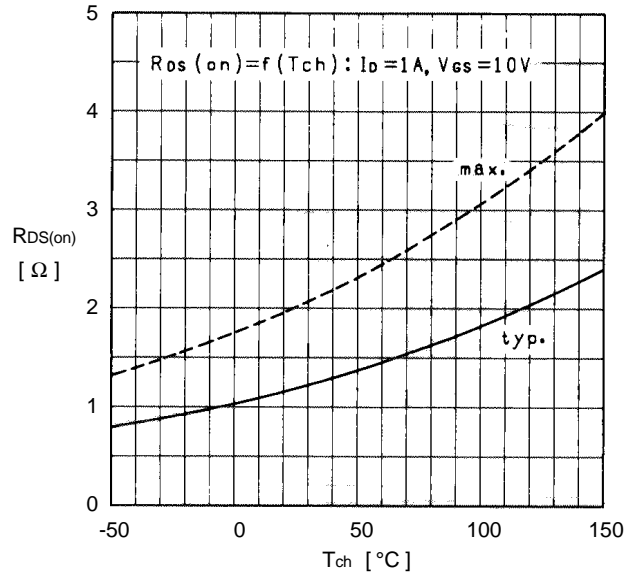

Typical transfer characteristics

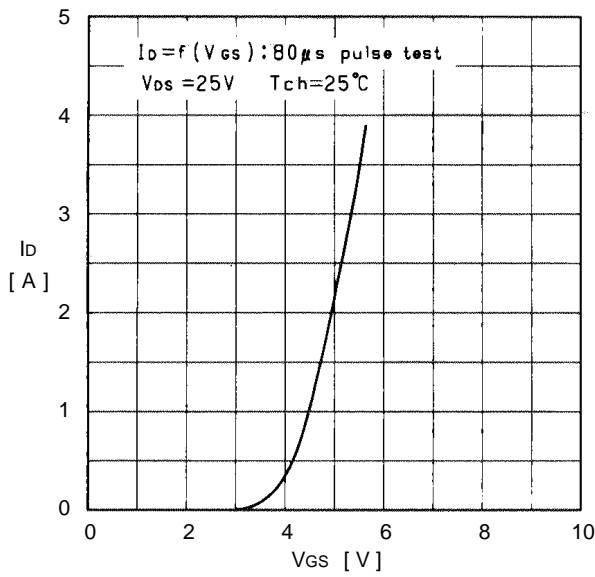

Typical Drain-Source on state resistance vs. I_D

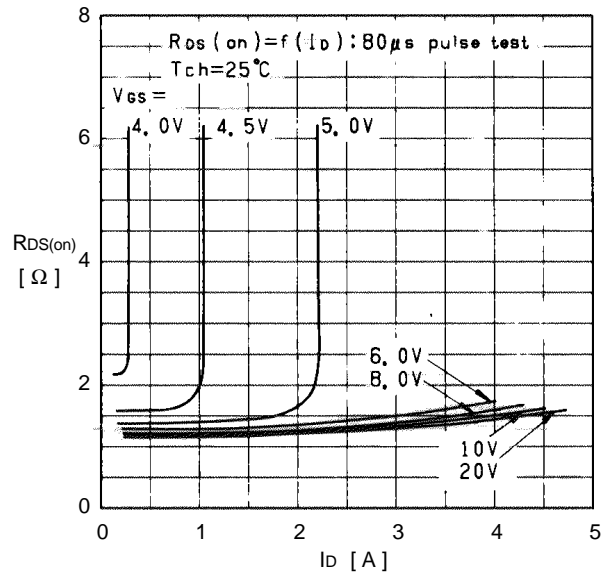

Typical forward transconductance vs. I_D

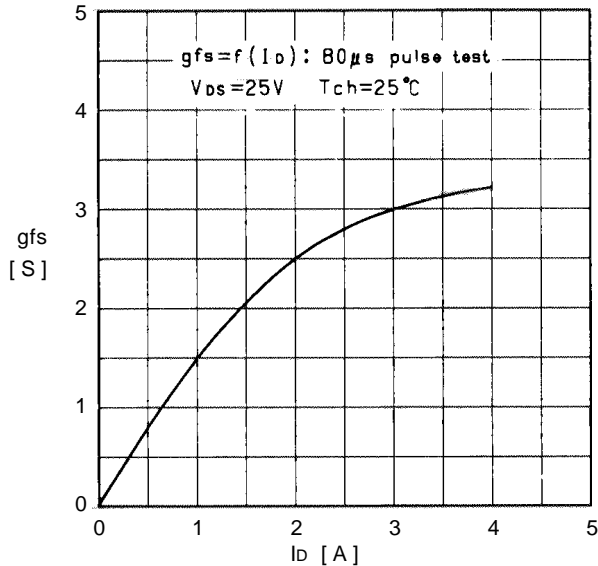

Gate threshold voltage vs. T_{ch}

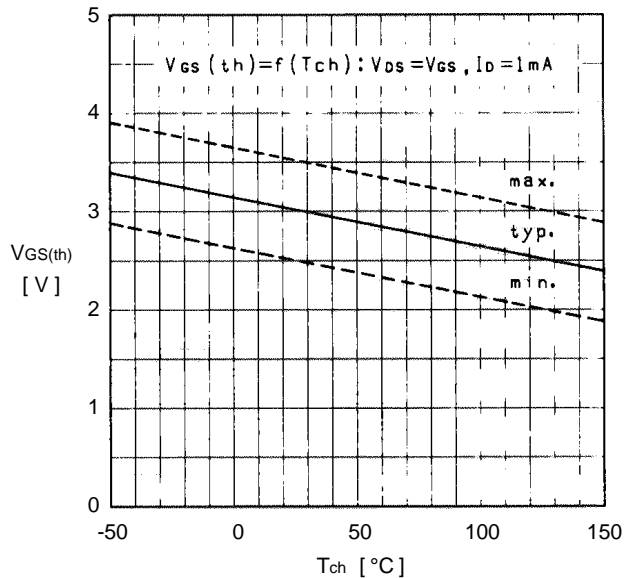

Typical capacitance vs. V_{DS}

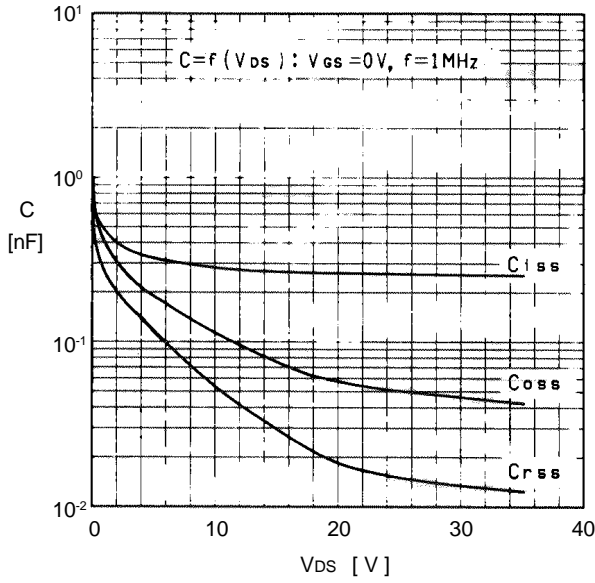

Typical input charge

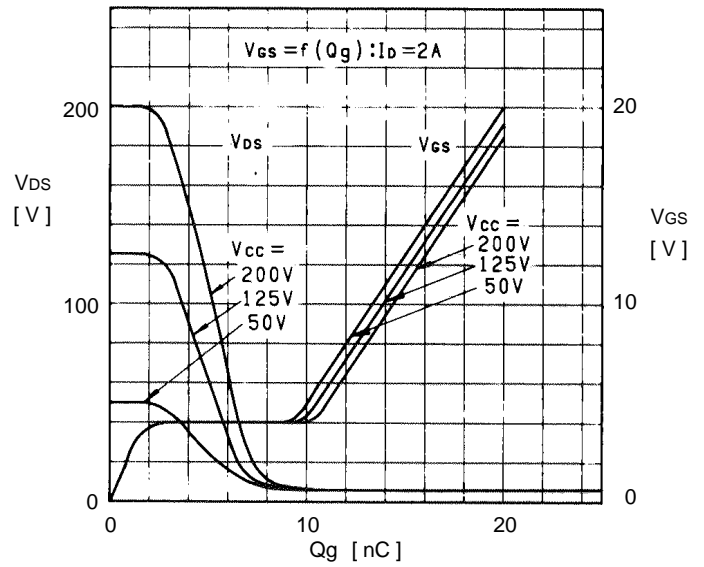

Forward characteristics of reverse diode

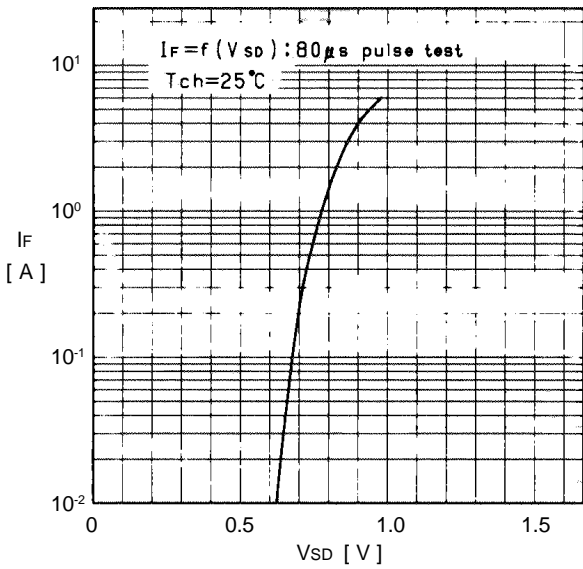

Allowable power dissipation vs. T_c

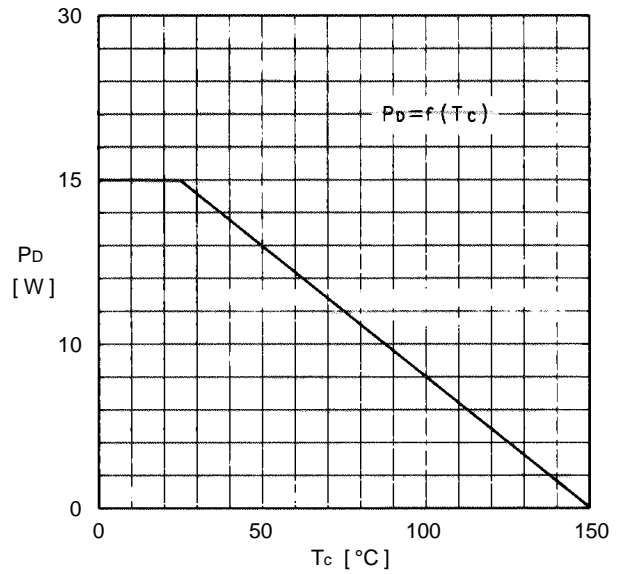

Safe operating area

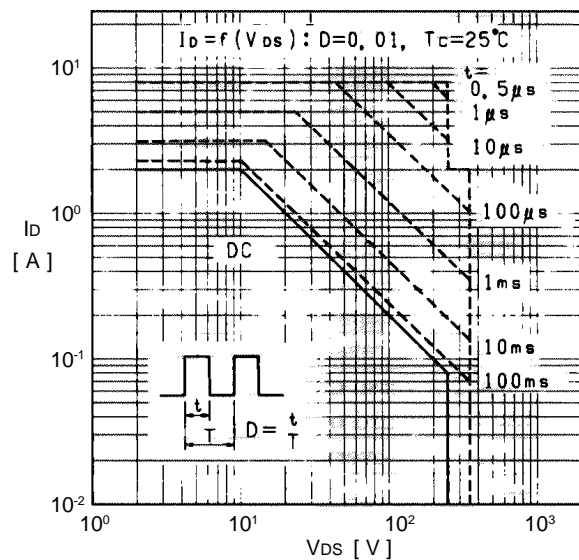

Transient thermal impedance

