

*RoHS COMPLIANT



BOURNS®

Features

- 6 mm Round / Single-Turn / Cermet Industrial / Open Frame
- Cross slot adjustment options
- Horizontal and vertical mounting styles
- Dust resistant/splash resistant covers
- PC board stand-offs and retention feature
- Front and top adjust styles
- RoHS compliant*
- For trimmer applications/processing guidelines, [click here](#)

3306 - 6 mm Round Trimpot® Trimming Potentiometer

Electrical Characteristics

Standard Resistance Range100 ohms to 1 megohm
 (see standard resistance table)
 Resistance Tolerance ±25 % std.
 (tighter tolerance available)
 Absolute Minimum Resistance 2 % max. (≤2K = 30 ohms)
 Contact Resistance Variation. 3 % max.
 Resolution Essentially infinite
 Adjustment Angle 215 ° nom.

Environmental Characteristics

Power Rating (100 volts max.)
 70 °C 0.2 watt
 Temperature Range ... -25 °C to +100 °C
 Temperature Coefficient ... ±250 ppm/°C
 Load Life ..1,000 hours 0.2 watt @ 70 °C
 (5 % ΔTR)

Physical Characteristics

Mechanical Angle 260 ° ±20 °
 Torque (Operating) 4.5 oz-in. max.
 Stop Strength 6.5 oz-in. min.
 Terminals Solderable pins
 Marking Manufacturer's trademark, resistance code
 Standard Packaging 200 pcs. per bag
 Adjustment Tool H-90

Aqueous cleaning not recommended.

How To Order

3306 W - 1 - 103

Model _____
 Style _____
 Standard Product _____
 Resistance Code _____

Standard Resistance Table

Resistance (Ohms)	Resistance Code
100	101
200	201
500	501
1,000	102
2,000	202
5,000	502
10,000	103
20,000	203
25,000	253
50,000	503
100,000	104
200,000	204
250,000	254
500,000	504
1,000,000	105

Popular distribution resistance values listed in boldface.

Product Dimensions

Top Adjust Common Dimensions

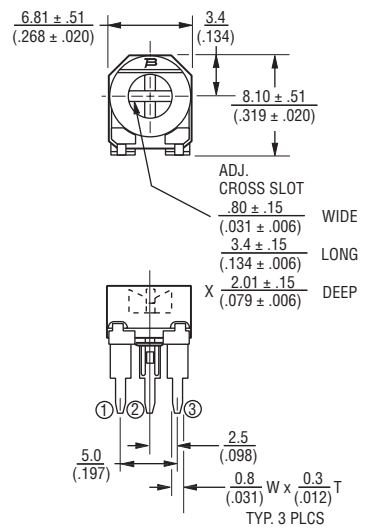

3306P

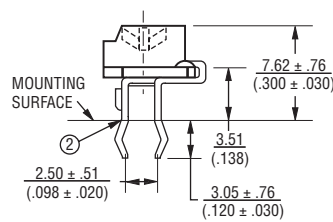

3306F

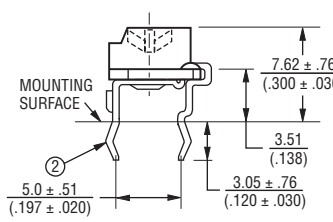

SUGGESTED PWB LAYOUT - STYLE F

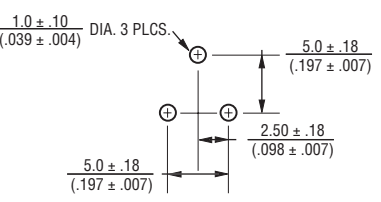

Side Adjust Common Dimensions

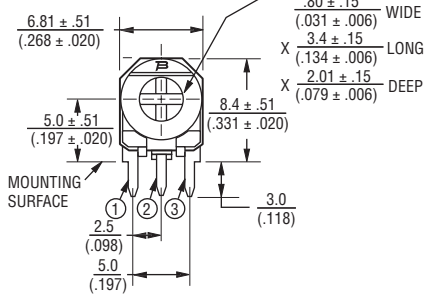

3306W

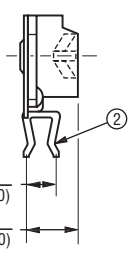

3306K

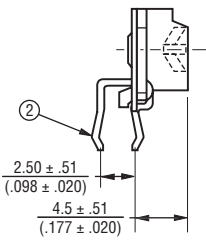

SUGGESTED PWB LAYOUT - STYLES K, P, W

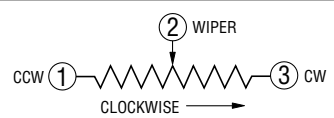
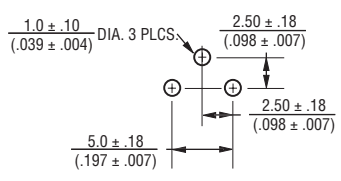

DIMENSIONS: $\frac{\text{MM}}{\text{(INCHES)}}$
 TOLERANCES: ± $\frac{0.25}{(.010)}$ EXCEPT WHERE NOTED

REV. 08/10

*RoHS Directive 2002/95/EC Jan 27 2003 including Annex. "Trimpot" is a registered trademark of Bourns, Inc. Specifications are subject to change without notice. Customers should verify actual device performance in their specific applications.