

XBee-PRO® XSC RF Module

XBee-PRO® XSC RF Module
RF Module Operation
RF Module Configuration
Appendices

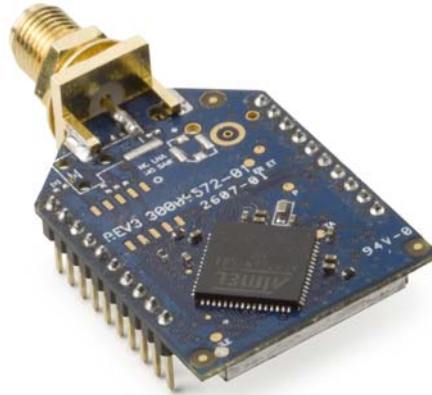

Product Manual [90000938-B](#)

For RF Module Part Number:
XBP09-XC...

900 MHz OEM RF Modules by Digi International Inc.



11001 Bren Road East
Minnetonka, MN 55343
www.digi.com

90000938_B
3, 17, 2010

© 2010 Digi International, Inc. All rights reserved

No part of the contents of this manual may be transmitted or reproduced in any form or by any means without the written permission of Digi International, Inc.

XBee-PRO® is a registered trademark of Digi International Inc.

Technical Support:

Phone: (801) 765-9885

Live Chat: www.digi.com

Contents

1. XBee-PRO® XSC OEM RF Module.....	4
Key Features.....	5
Worldwide Acceptance	5
Specifications	6
Pin Signals.....	7
Electrical Characteristics	8
Timing Specifications	8
Mechanical Drawings	9
2. RF Module Operation	10
Serial Communications	10
UART-Interfaced Data Flow.....	10
Serial Data	10
Flow Control	11
Modes of Operation	12
Idle Mode	12
Transmit Mode.....	12
Receive Mode	14
Sleep Mode	14
Command Mode	17
3. RF Module Configuration.....	19
XBee Programming Examples	19
AT Commands	19
Binary Commands	19
Command Reference Table	20
Command Descriptions	21
Appendix A: Agency Certifications.....	38
FCC (United States) Certification	38
Labeling Requirements	38
FCC Notices	38
Limited Modular Approval	38
FCC-approved Antennas	39
IC (Industry Canada) Certification	39
Appendix B: Additional Information	43
1-Year Warranty.....	43
Ordering Information	43
Contact Digi	45

1. XBee-PRO® XSC OEM RF Module

The XBee-PRO XSC (900 MHz) OEM RF Modules were engineered to afford OEMs and integrators an easy-to-use RF solution that provides reliable delivery of critical data between remote devices. These modules come configured to sustain reliable long-range wireless links.

The XBee Module is a drop-in wireless solution that transfers a standard asynchronous serial data stream.



1.1. Key Features

Long Range Data Integrity

- XBee-PRO XSC (900 MHz) Range:
- Indoor/Urban: up to 1200' (370m)
 - Outdoor line-of-sight: up to 6 miles (9.6 km) w/ 2.1 dBm dipole antenna
 - Outdoor line-of-sight: up to 15 miles (24 km) w/ high gain antenna
 - Receiver Sensitivity: -106 dBm,
 - Advanced Networking & Security
 - True peer-to-peer (no "master" required) communications
 - Point-to-point & point-to-multipoint topologies supported
 - Retries and Acknowledgements
 - 7 hopping channels, each with over 65,000 available network addresses
 - FHSS (Frequency Hopping Spread Spectrum)
 - Input pins are 5 volt tolerant

Easy-to-Use

- Continuous RF data stream up to 9600 bps
- No configuration required for out-of-the-box RF data communications
- Advanced configurations available through standard AT & binary Commands
- Portable (small form factor easily designed into a wide range of data radio systems)
- Software-selectable serial interface baud rates
- CTS, RTS (& more) I/O Support
- Support for multiple data formats (parity, start and stop bits, etc.)
- Power-saving Sleep Modes

1.1.1. Worldwide Acceptance

FCC Certified (USA) - Refer to Appendix A for FCC Requirements.
Systems that include XBee-PRO Modules inherit Digi's FCC Certification

ISM (Industrial, Scientific & Medical) frequency band

Manufactured under **ISO 9001:2000** registered standards

XBee-PRO™ XSC (900 MHz) OEM RF Modules are approved for use in **US** and **Canada**.

RoHS compliant



1.2. Specifications

Table 1-01. XBee-PRO XSC OEM RF Module Specifications

Specification	XBee-PRO XSC (900 MHz) OEM RF Module
Performance	
Indoor/Urban Range	up to 1200ft (370m)
Outdoor line-of-sight Range	Up to 6 miles (9.6km) w/ dipole antenna Up to 15 miles (24 km) w/ high-gain antenna
Interface Data Rate	125 - 65,000 bps (Software selectable, includes non-standard baud rates)
Throughput Data Rate	9,600 bps 10 kbps 100 mW (+20 dBm) -106dBm
RF Data Rate	
Transmit Power Output	
Receiver Sensitivity	
Power Requirements	
Supply Voltage	3.0-3.6 VDC regulated
Receive Current	65mA
Transmit Current	265mA
Power Down Current	50 μ A
General	
Frequency Range	902-928 MHzMHz (located in the 900MHz ISM Band)
Spread Spectrum	Frequency Hopping
Network Topology	Point-to-Point, Peer-to-Peer, Point-to-Multipoint
Channel Capacity	7 hop sequences share 25 frequencies
Board-level Serial Data Interface	3V CMOS UART (5V-tolerant)
Physical Properties	
Module Board Size	1.297" x 0.962" x 0.215 (3.29 cm x 2.44 cm x 0.546 cm) Note: Dimensions do not include connector/antenna or pin lengths
Weight	5 to 8 grams, depending on the antenna option
Connector	2 rows of 10 pins, 22mm apart with 2mm spaced male Berg-type headers
Operating Temperature	-40 to 85° C (industrial)
Antenna Options	
Integrated Wire	¼ wave monopole, 3.25" (8.26 cm) length, 1.9 dBi Gain
Integrated Helical	0.315" (0.8 cm) height
RF Connector	Reverse-polarity SMA or U.FL
Impedance	50 ohms unbalanced
Certifications)	
FCC Part 15.247	MXQ-XBEEEXSC
Industry Canada (IC)	1846A-XBEEEXSC
Europe	N/A
RoHS	Compliant

1.3. Pin Signals

Figure 1-01. XBee-PRO XSC OEM RF Module Pin Numbers (top view, shield underneath)

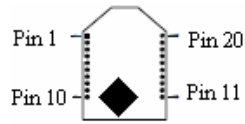

Table 1-02. J1 Pin Signal Descriptions
(Low-asserted signals distinguished with a horizontal line over signal name.)

Module Pin	Public Signal	Notes	I/O	When Active	Function
1	VCC		I		3.0VDC to 3.6VDC
2	DO (Data Out)		O	n/a	Serial data exiting the module (to the UART host). Refer to the Serial Communications section for more information
3	DI (Data In)		I	n/a	Serial data entering the module (from UART host). Refer to the Serial Communications section for more information.
4	DO3 / RX LED		O	high	Pin is driven high during RF data reception; otherwise, the pin is driven low. Refer to the CD Command section to enable.
5	$\overline{\text{Reset}}$	Has a 10k pull up resistor	I/O	low	Re-boot module.(minimum pulse is 90us) Open Drain configuration. Module will drive reset line low momentarily on reboot and power up.
6	$\overline{\text{Config}}$	Has a 100k pull up resistor	I	low / high	Pin can be used as a backup method for entering Command Mode during power-up. Primary method is with "+++". Refer to the AT Commands section for more information.
7			O	Driven high	Do not Connect
8			NC		Do not Connect
9	DI3 / SLEEP	Has a 100k pull up resistor	I	high	By default, DI3 pin is not used. To configure this pin to support Sleep Modes, refer to the Sleep Mode, SM Command and PW Command sections.
10	GND				Ground
11			O	Driven high	Do not Connect
12	DO2 / $\overline{\text{CTS}}$ / RS-485 Enable		O	low	$\overline{\text{CTS}}$ (clear-to-send) flow control - When pin is driven low, UART host is permitted to send serial data to the module. Refer to the Serial Communications and CS Command sections for more information. ----- RS-485 Enable - To configure this pin to enable RS-485 (2-wire or 4-wire) communications, refer to the Serial Communications and CS Command sections.
13	ON / $\overline{\text{Sleep}}$		O	high	high = Indicates power is on and module is not in Sleep Mode. Low = Sleep mode or module is unpowered
14	VREF		I	n/a	Not used on this module. For compatibility with other XBee modules, we recommend connecting this pin to a voltage reference if Analog sampling is desired. Otherwise, connect to GND.
15	$\overline{\text{TX}}$ / PWR		O	n/a	low = $\overline{\text{TX}}$ - Pin pulses low during transmission ----- high = PWR - Indicates power is on and module is not in Sleep Mode
16	DI2 / $\overline{\text{RTS}}$ / CMD	Has a 100k pull down resistor	I	low	$\overline{\text{RTS}}$ (request-to-send) flow control - By default, this pin is not used. To configure this pin to regulate the flow of serial data exiting the module, refer to the Serial Communications and RT Command sections. ----- CMD - Refer to Binary Commands and RT Command sections to enable binary command programming.
17			O	Driven low	Do not Connect
18			O	Driven low	Do not Connect

Module Pin	Public Signal	Notes	I/O	When Active	Function
19			O	Driven low	Do not Connect
20			O	Driven low	Do not Connect

1.4. Electrical Characteristics

Figure 1-02. System Block Diagram
Basic wireless link between hosts

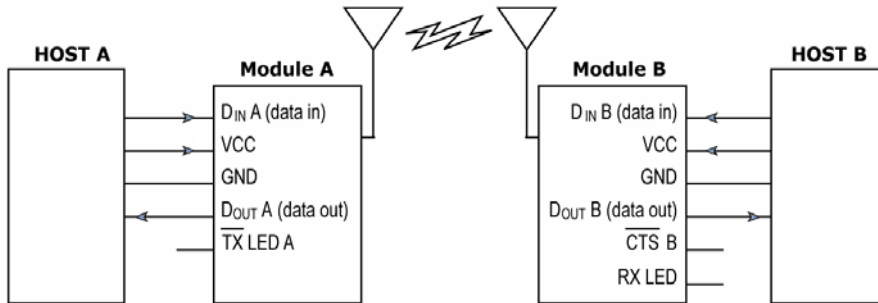

The data flow sequence is initiated when the first byte of data is received in the DI Buffer of the transmitting module (XBee Module A). As long as XBee Module A is not already receiving RF data, data in the DI Buffer is packetized, then transmitted over-the-air to XBee Module B.

1.4.1. Timing Specifications

Figure 1-03. Timing Specifications ("A" and "B" refer to Figure 1-02.)

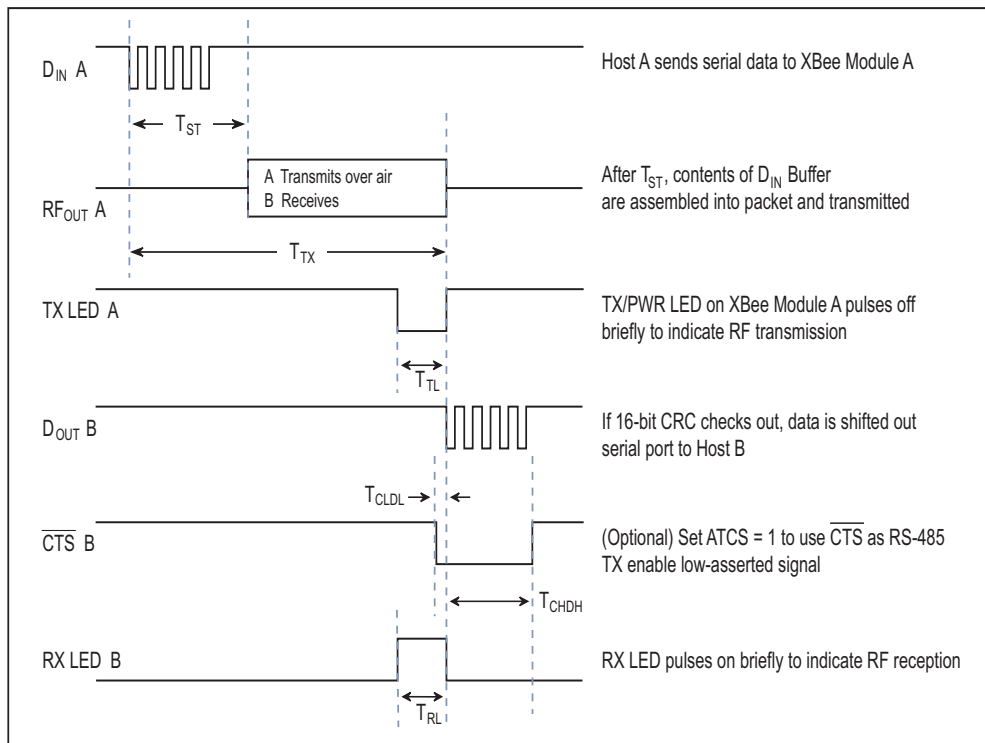

Table 1-03. AC Characteristics (SY parameter = 0, symbols correspond to Figure 1-02 and Figure 1-03.)

Symbol	Description	9600 baud rate (32 byte packet)	9600 timing (B=number of bytes)
T _{TX}	Latency from the time data is transmitted until received	72.0 ms	For 0 < B < 40, T = 46.27 + (0.73 * B) ms For B >= 39 bytes, T = 74.80 ms
T _{TL}	Time that TX/PWR pin is driven low	16.8 ms	For 0 < B < 14, T = 6.50 + (0.8 * B) ms For B > 13 T = 16.80 ms
T _{RL}	Time that RX LED pin is driven high	25.6 ms	For 0 < B < 37, T = 1.63 + (0.794 * B) For B > 36, T = 30.2 ms
T _{ST}	Channel Initialization Time	35.0 ms	35.0 ms

Table 1-04. DC Characteristics (Vcc = 3.0-3.6 VDC)

Symbol	Parameter	Condition	Min	Typical	Max	Units
V _{cc}	Module Supply Voltage		3.0		3.6	V
V _{IL}	Input Low Voltage	All input signals	-0.3		0.8	V
V _{IH}	Input High voltage	All input signals	2.0		5.5	V
V _{OL}	Output Low-Level Voltage	I _{out} = I _{out_Max}			0.4	V
V _{OH}	Output High-Level Voltage	I _{out} = I _{out_Max}	V _{cc} -0.4			V
I _L	Input Leakage Current	With Pull-up resistors disabled		40	400	nA
I _{O1}	Output Current	pins 2, 15 (Dout, ~TX/Pwr)			2	mA
I _{O2}	Output Current	pins 4, 12, 13 (DCD,-CTS,ON/-Sleep)			8	mA

1.5. Mechanical Drawings

Figure 1-04. Mechanical Drawings

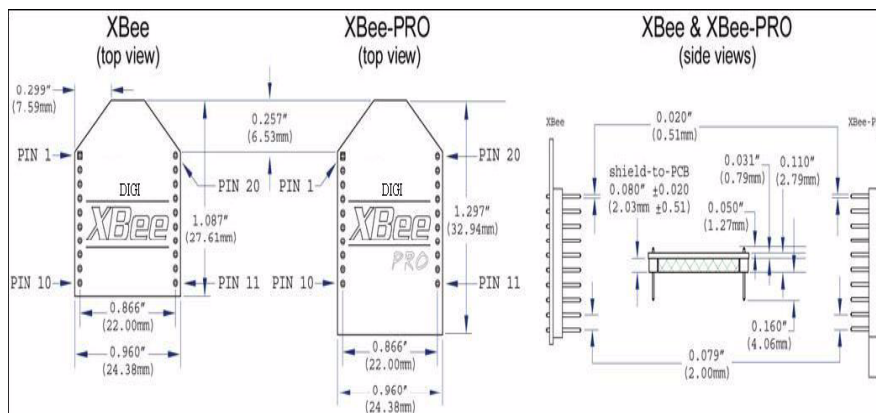

2. RF Module Operation

2.1. Serial Communications

The XBee module interfaces to a host device through a CMOS-level asynchronous serial port. Through its serial port, the module can communicate with any UART voltage compatible device or through a level translator to any RS-232/485/422 device.

2.1.1. UART-Interfaced Data Flow

Devices that have a UART interface can connect directly through the pins of the XBee module as shown in the figure below.

Figure 2-01. System Data Flow Diagram in a UART-interfaced environment
(Low-asserted signals distinguished with horizontal line over signal name.)

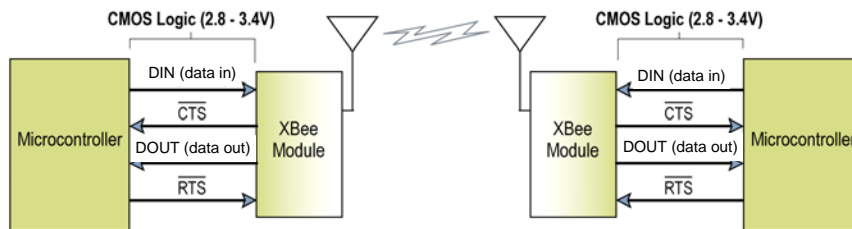

2.1.2. Serial Data

Data enters the XBee module through the DI pin as an asynchronous serial signal. The signal should idle high when no data is being transmitted.

The UART performs tasks, such as timing and parity checking, that are needed for data communications. Serial communication consists of two UARTs, one being the XBee's and the other being the Microcontroller's, configured with compatible parameters (baud rate, parity, start bits, stop bits, data bits) to have successful communication. Each data packet consists of a start bit (low), 8 data bits (least significant bit first) and a stop bit (high). The following figure illustrates the serial bit pattern of data passing through the module.

Figure 2-02. UART data packet 0x1F (decimal number "31") as transmitted through the XBee Module
Example Data Format is 8-N-1 (bits - parity - # of stop bits)

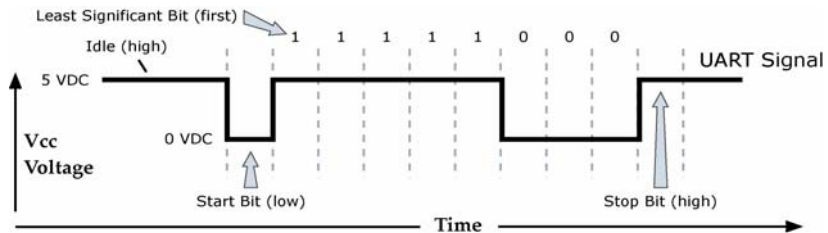

2.1.3. Flow Control

Figure 2-03. Internal Data Flow Diagram (The five most commonly-used pin signals shown.)

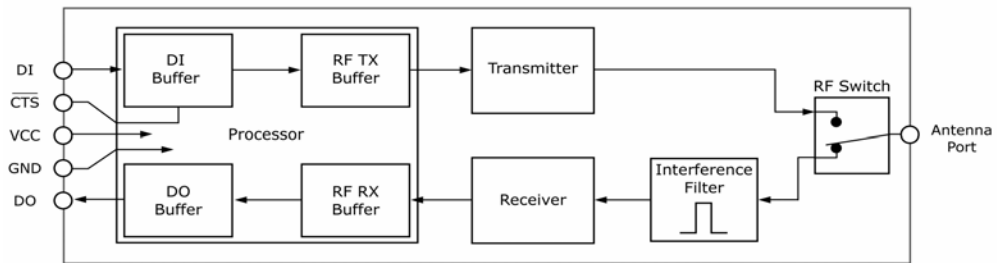

DI (Data In) Buffer and Flow Control

When serial data enters the XBee module through the DI Pin, then the data is stored in the DI Buffer until it can be transmitted.

When the RO parameter threshold is satisfied (refer to Transmit Mode and Command Descriptions sections for more information), the module attempts to initialize an RF connection. If the module is already receiving RF data, the serial data is stored in the module's DI Buffer. If the DI buffer becomes full, hardware or software flow control must be implemented in order to prevent overflow (loss of data between the host and XBee OEM RF Module).

How to eliminate the need for flow control:

- Send messages that are smaller than the DI buffer size, which is generally around 1,000 bytes.
- Interface at a lower baud rate (BD parameter) than the fixed RF data rate with the Retries functionality (RR parameter) disabled.

Two cases in which the DI Buffer may become full and possibly overflow:

- If the serial interface data rate is set higher than the RF data rate of the module, the module will receive data from the host faster than it can transmit the data over-the-air.
- If the module is receiving a continuous stream of data, monitoring data on a network, or awaiting acknowledgments for Retries functionality, any serial data that arrives on the DI pin is placed in the DI Buffer. The data in the DI buffer will be transmitted over-the-air when the module no longer detects RF data in the network.

Hardware Flow Control ($\overline{\text{CTS}}$). When the DI buffer is 65 bytes away from being full; by default, the module de-asserts (high) $\overline{\text{CTS}}$ to signal to the host device to stop sending data [refer to FT (Flow Control Threshold) and CS (DO2 Configuration) Commands]. $\overline{\text{CTS}}$ is re-asserted after the DI Buffer has 34 bytes of memory available.

Software Flow Control (XON). XON/XOFF software flow control can be enabled using the FL (Software Flow Control) command.

DO (Data Out) Buffer and Flow Control

When RF data is received, the data enters the DO buffer and is then sent out the serial port to a host device. Once the DO Buffer reaches capacity, any additional incoming RF data is lost.

Two cases in which the DO Buffer may become full and possibly overflow:

- If the RF data rate is higher than the set interface data rate of the module, the module will receive data from the transmitting module faster than it can send the data to the host.
- If the host does not allow the RF module to send data out of the DO buffer because of hardware or software flow control.

Hardware Flow Control ($\overline{\text{RTS}}$). If $\overline{\text{RTS}}$ is enabled for flow control (RT Parameter = 2), data will not be sent out the DO Buffer as long as $\overline{\text{RTS}}$ (pin 16) is de-asserted.

Software Flow Control (XOFF). XON/XOFF software flow control can be enabled using the FL (Software Flow Control) Command. This option only works with ASCII data.

2.2. Modes of Operation

XBee-PRO® XSC RF Modules operate in five modes.

Figure 2-04. Modes of Operation

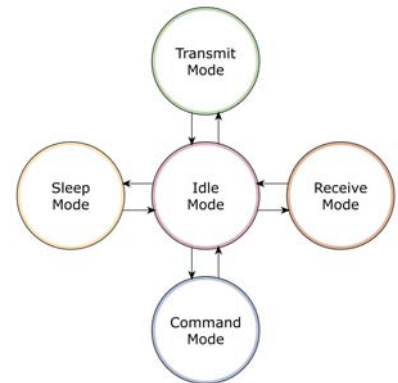

2.2.1. Idle Mode

When not receiving or transmitting data, the RF module is in Idle Mode. The module shifts into the other modes of operation under the following conditions:

- Transmit Mode (Serial data is received in the DI Buffer)
- Receive Mode (Valid RF data is received through the antenna)
- Sleep Mode (Sleep Mode condition is met)
- Command Mode (Command Mode Sequence is issued)

2.2.2. Transmit Mode

When the first byte of serial data is received from the UART in the DI buffer, the module attempts to shift to Transmit Mode and initiate an RF connection with other modules.

Figure 2-05. Transmission of Data

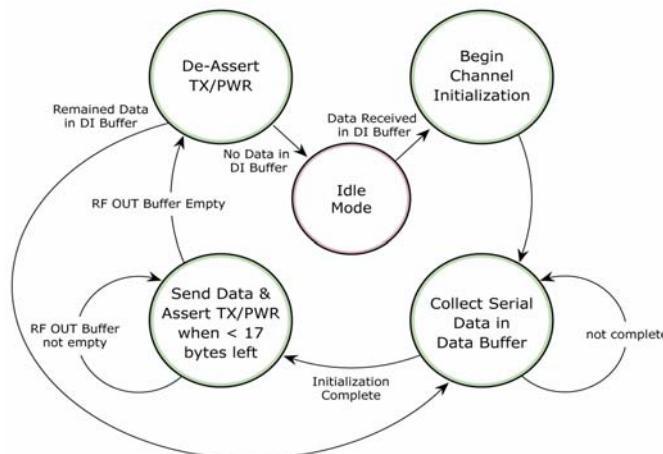

Once in Transmit Mode, the module initializes a communications channel. Channel initialization is the process of sending an RF initializer that synchronizes receiving modules with the transmitting module. When streaming multiple RF packets, the RF Initializer is only sent in front of the first packet. During channel initialization, incoming serial data accumulates in the DI buffer.

After the channel is initialized, data in the DI buffer is grouped into packets (up to 64 bytes in each packet) and is transmitted. The module continues to transmit data packets until the DI buffer is empty. Once transmission is finished, the module returns to Idle Mode. This progression is shown in Figure 2-05.

As the transmitting module nears the end of the transmission, it inspects the DI buffer to see if more data exists to be transmitted. This could be the case if more bytes arrived from the host after the transmission began. If more data is pending, the transmitting module assembles a subsequent packet for transmission.

RF Packet

Figure 2-06. RF Packet Components

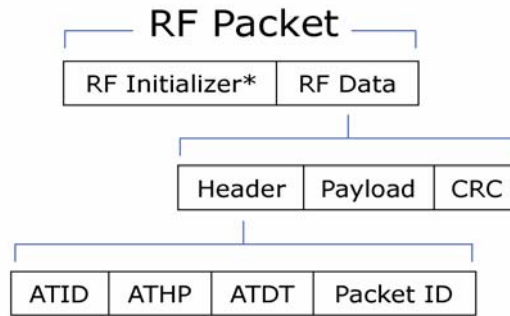

* When streaming multiple RF packets, the RF Initializer is only sent in front of the first packet.

RF Initializer

An RF initializer is sent each time a new connection sequence begins. The RF initializer contains channel information that notifies receiving modules of information such as the hopping pattern used by the transmitting module. The first transmission always sends an RF initializer.

An RF initializer can be of various lengths depending on the amount of time determined to be required to prepare a receiving module. For example, a wake-up initializer is a type of RF initializer used to wake remote modules from Sleep Mode (Refer to the FH, LH, HT and SM Commands for more information). The length of the wake-up initializer should be longer than the length of time remote modules are in cyclic sleep.

Header

The header contains network addressing information that filters incoming RF data. The receiving module checks for a matching VID, Hopping Channel and Destination Address. Data that does not pass through all three network filter layers is discarded.

Figure 2-07. Addressing Layers contained in the Header

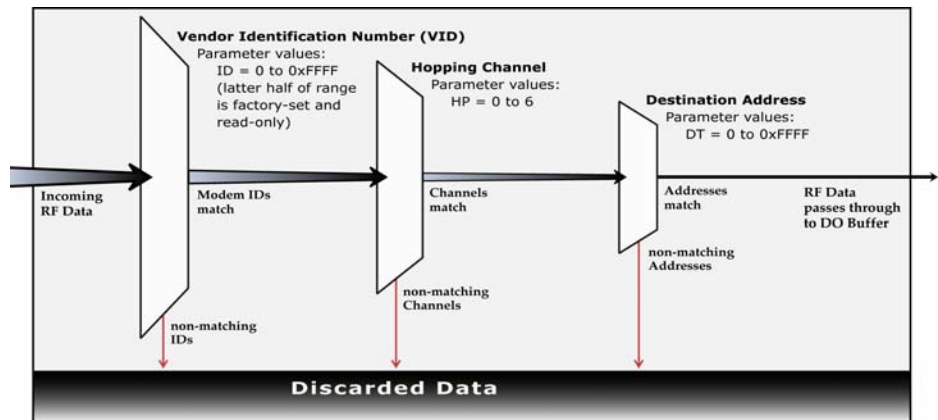

CRC (Cyclic Redundancy Check)

To verify data integrity and provide built-in error checking, a 16-bit CRC (Cyclic Redundancy Check) is computed for the transmitted data and attached to the end of each RF packet. On the receiving end, the receiving module computes the CRC on all incoming RF data. Received data that has an invalid CRC is discarded [See Receive Mode section, next page].

2.2.3. Receive Mode

If a module detects RF data while operating in Idle Mode, the module transitions into Receive Mode to start receiving RF packets.

Figure 2-08. Reception of RF Data

After a packet is received, the module checks the CRC (cyclic redundancy check) to ensure that the data was transmitted without error. If the CRC data bits on the incoming packet are invalid, the packet is discarded. If the CRC is valid, the packet proceeds to the DO Buffer.

The module returns to Idle Mode after valid RF data is no longer detected or after an error is detected in the received RF data. If serial data is stored in the DI buffer while the module is in Receive Mode, the serial data will be transmitted after the module is finished receiving data and returns to Idle Mode.

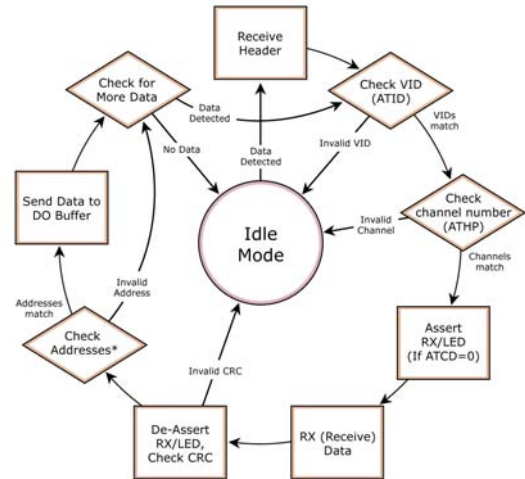

2.2.4. Sleep Mode

Sleep Modes enable the XBee module to operate at minimal power consumption when not in use. The following Sleep Mode options are available:

- Pin Sleep
- Cyclic Sleep

For the module to transition into Sleep Mode, the module must have a non-zero SM (Sleep Mode) Parameter and one of the following must occur:

- The module is idle (no data transmission or reception) for a user-defined period of time [Refer to the ST (Time before Sleep) Command].
- SLEEP is asserted (only for Pin Sleep option).

In Sleep Mode, the module will not transmit or receive data until the module first transitions to Idle Mode. All Sleep Modes are enabled and disabled using SM Command. Transitions into and out of Sleep Modes are triggered by various events as shown in the table below.

Table 2-01. Summary of Sleep Mode Configurations

Sleep Mode Setting	Transition into Sleep Mode	Transition out of Sleep Mode	Related Commands	Typical Power Consumption
Pin Sleep (SM = 1)	Microcontroller can shut down and wake modules by asserting (high) SLEEP (pin 9). Note: The module will complete a transmission or reception before activating Pin Sleep.	De-assert (low) SLEEP (pin 9).	SM	50 µA
Cyclic Sleep (SM = 3-8)	Automatic transition to Sleep Mode occurs in cycles as defined by the SM (Sleep Mode) Command. Note: The cyclic sleep time interval must be shorter than the "Wake-up Initializer Timer" (set by LH Command).	After the cyclic sleep time interval elapses. Note: Module can be forced into Idle Mode if PW (Pin Wake-up) Command is enabled.	SM, ST, HT, LH, PW	76 µA when sleeping

Pin Sleep (SM = 1)

Pin Sleep requires the least amount of power. In order to achieve this state, SLEEP pin must be asserted (high). The module remains in Pin Sleep until the SLEEP pin is de-asserted.

After enabling Pin Sleep, the SLEEP pin controls whether the XBee module is active or in Sleep Mode. When SLEEP is de-asserted (low), the module is fully operational. When SLEEP is asserted (high), the module transitions to Sleep Mode and remains in its lowest power-consuming state until the SLEEP pin is de-asserted. SLEEP is only active if the module is setup to operate in this mode; otherwise the pin is ignored.

Once in Pin Sleep Mode, $\overline{\text{CTS}}$ is de-asserted (high), indicating that data should not be sent to the module. The PWR pin is also de-asserted (low) when the module is in Pin Sleep Mode.

Note: The module will complete a transmission or reception before activating Pin Sleep.

Cyclic Sleep (SM = 3-8)

Cyclic Sleep is the Sleep Mode in which the XBee module enters into a low-power state and awakens periodically to determine if any transmissions are being sent.

When Cyclic Sleep settings are enabled, the XBee module goes into Sleep Mode after a user-defined period of inactivity (no transmission or reception on the RF channel). The user-defined period is determined by ST (Time before Sleep) Command.

While the module is in Cyclic Sleep Mode, $\overline{\text{CTS}}$ is de-asserted (high) to indicate that data should not be sent to the module during this time. When the module awakens to listen for data, $\overline{\text{CTS}}$ is asserted and any data received on the DI Pin is transmitted. The PWR pin is also de-asserted (low) when the module is in Cyclic Sleep Mode.

The module remains in Sleep Mode for a user-defined period of time ranging from 0.5 seconds to 16 seconds (SM Parameters 3 through 8). After this interval of time, the module returns to Idle Mode and listens for a valid data packet for 100 ms. If the module does not detect valid data (on any frequency), the module returns to Sleep Mode. If valid data is detected, the module transitions into Receive Mode and receives incoming RF packets. The module then returns to Sleep Mode after a Period of inactivity that is determined by ST "Time before Sleep" Command.

The module can also be configured to wake from cyclic sleep when SLEEP (pin 9) is de-asserted (low). To configure a module to operate in this manner, PW (Pin Wake-up) Command must be issued. Once SLEEP is de-asserted, the module is forced into Idle Mode and can begin transmitting or receiving data. It remains active until no data is detected for the period of time specified by the ST Command, at which point it resumes its low-power cyclic state.

Note: The cyclic interval time defined by SM (Sleep Mode) Command must be shorter than the interval time defined by LH (Wake-up Initializer Timer).

For example: If SM=4 (Cyclic 1.0 second sleep), the LH Parameter should equal 0x0B ("1.1" seconds). With these parameters set, there is no risk of the receiving module being asleep for the duration of wake-up initializer transmission. "Cyclic Scanning" explains in further detail the relationship between "Cyclic Sleep" and "Wake-up Initializer Timer"

Cyclic Scanning. Each RF transmission consists of an RF Initializer and payload. The wake-up initializer contains initialization information and all receiving modules must wake during the wake-up initializer portion of data transmission in order to be synchronized with the transmitting module and receive the data.

Figure 2-09. Correct Configuration (LH > SM)

Length of the wake-up initializer exceeds the time interval of Cyclic Sleep. The receiver is guaranteed to detect the wake-up initializer and receive the accompanying payload data.

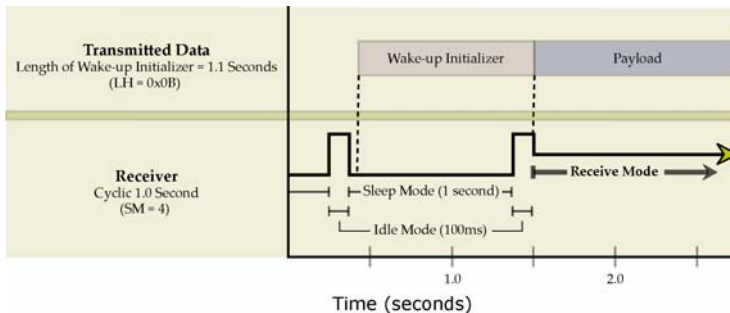
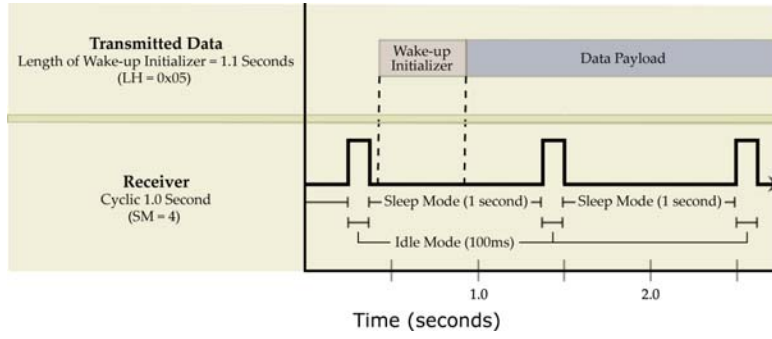

Figure 2-010. Incorrect Configuration (LH < SM)

Length of wake-up initializer is shorter than the time interval of Cyclic Sleep. This configuration is vulnerable to the receiver waking and missing the wake-up initializer (and therefore also the accompanying payload data).



2.2.5. Command Mode

To modify or read module parameters, the module must first enter into Command Mode, the state in which received characters on the UART are interpreted as commands. Two command types are available for programming the module:

- AT Commands
- Binary Commands

For modified parameter values to persist in the module registry, changes must be saved to non-volatile memory using WR (Write) Command. Otherwise, parameters are restored to previously saved values after the module is powered off and then on again.

AT Commands

To Enter AT Command Mode:

- Send the 3-character command sequence "+++" and observe guard times before and after the command characters. [refer to 'Default AT Command Mode Sequence' below.] The 'Terminal' tab (or other serial communications software) of the X-CTU Software can be used to enter the sequence.

[OR]

- Assert (low) the $\overline{\text{CONFIG}}$ pin and either turn the power going to the module off and back on. (If using a Digi XBIB-R Interface Board, the same result can be achieved by holding the Data-In line low (also known as a break) while rebooting the module by pressing the reset button on the module assembly [module assembly = module mounted to an interface board]).

Default AT Command Mode Sequence (for transition to Command Mode):

- No characters sent for one second [refer to the BT (Guard Time Before) Command]
- Input three plus characters ("+++") within one second [refer to the CC (Command Sequence Character) Command.]
- No characters sent for one second [refer to the AT (Guard Time After) Command.]

To Send AT Commands:

Send AT commands and parameters using the syntax shown below.

Figure 2-11. Syntax for sending AT Commands

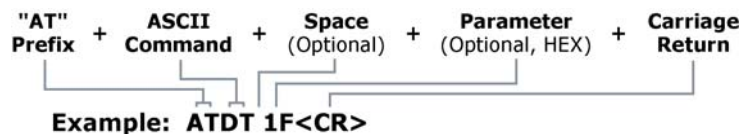

To read a parameter value stored in the module register, leave the parameter field blank.

The preceding example would change the module's Destination Address to "0x1F". To store the new value to non-volatile (long term) memory, the Write (ATWR) command must subsequently be sent before powering off the module.

System Response. When a command is sent to the module, the module will parse and execute the command. Upon successful execution of a command, the module returns an "OK" message. If execution of a command results in an error, the module returns an "ERROR" message.

To Exit AT Command Mode:

- If no valid AT Commands are received within the time specified by CT (Command Mode Timeout) Command, the module automatically returns to Idle Mode.

[OR]

- Send ATCN (Exit Command Mode) Command.

For an example of programming the RF module using AT Commands and descriptions of each configurable parameter, refer to the "RF Module Configuration" chapter.

Binary Commands

Sending and receiving parameter values using binary commands is the fastest way to change operating parameters of the module. Binary commands are used most often to sample signal strength (RS parameter) and/or error counts; or to change module addresses and channels for polling systems when a quick response is necessary. Since the sending and receiving of parameter values takes place through the same data path as 'live' data (received RF payload), follow the $\overline{\text{CTS}}$ pin as outlined in Figure 2-012 to distinguish between the two types of data (commands vs 'live' data).

Common questions regarding the use of binary commands:

- What are the implications of asserting CMD while live data is being sent or received?
- After sending serial data, is there a minimum time delay before CMD can be asserted?
- Is a time delay required after CMD is de-asserted before payload data can be sent?
- How to discern between live data and data received in response to a command?

CMD (pin 5) must be asserted in order to send binary commands to the module. The CMD pin can be asserted to recognize binary commands anytime during the transmission or reception of data. The status of the CMD signal is only checked at the end of the stop bit as the byte is shifted into the serial port. The application does not allow control over when data is received, except by waiting for dead time between bursts of communication.

If the command is sent in the middle of a stream of payload data to be transmitted, the command will essentially be executed in the order it is received. If the radio is continuously receiving data, the radio will wait for a break in the received data before executing the command. The $\overline{\text{CTS}}$ signal will frame the response coming from the binary command request [Figure 2-012].

A minimum time delay of 100 μs (after the stop bit of the command byte has been sent) must be observed before pin 5 can be de-asserted. The command executes after all parameters associated with the command have been sent. If all parameters are not received within 0.5 seconds, the module aborts the command and returns to Idle Mode.

Note: Binary commands that return only one parameter byte must also be written with two parameter bytes, 0-padded, LSB first.

Refer to "Programming Examples" section [pXX] for a binary programming example.

Commands can be queried for their current value by sending the command logically ORed (bit-wise) with the value 0x80 (hexadecimal) with CMD asserted. When the binary value is sent (with no parameters), the current value of the command parameter is sent back through the DO pin.

Figure 2-012. Binary Command Write then Read

Signal #4 is CMD (pin 16)

Signal #1 is the DIN (pin 3) signal to the radio

Signal #2 is the DOUT (pin 2) signal from the radio

Signal #3 is $\overline{\text{CTS}}$ (pin 12)

In this graph, a value was written to a register and then read out to verify it. While not in the middle of other received data, note that the $\overline{\text{CTS}}$ signal outlines the data response out of the module.

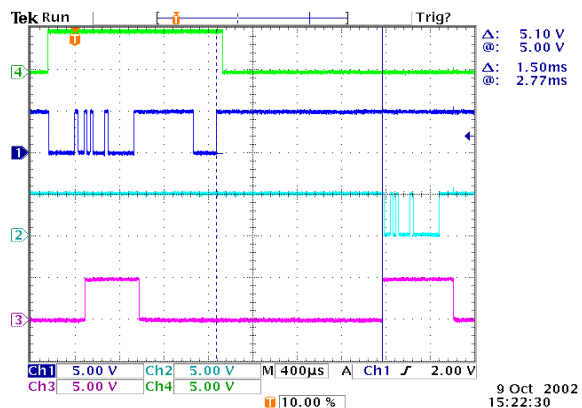

IMPORTANT: For the XBee module to recognize a binary command, the RT (DI2 Configuration) parameter must be set to one. If binary programming is not enabled RT = 0 or 2, the module will not recognize that the CMD pin is asserted and therefore will not recognize the data as binary commands.

3. RF Module Configuration

3.1. XBee Programming Examples

For information about entering and exiting AT and Binary Command Modes, refer to the Command Mode section.

3.1.1. AT Commands

To Send AT Commands (Using the 'Terminal' tab of the X-CTU Software)

Example: Utilize the 'Terminal' tab of the X-CTU Software to change the module's DT (Destination Address) parameter and save the new address to non-volatile memory. This example requires the installation of Digi's X-CTU Software and a serial connection to a PC.

Select the 'Terminal' tab of the X-CTU Software and enter the following command lines:

Method 1 (One line per command)

Send AT Command	System Response
+++	OK <CR> (Enter into Command Mode)
ATDT <Enter>	{current value} <CR> (Read Destination Address)
ATDT1A0D <Enter>	OK <CR> (Modify Destination Address)
ATWR <Enter>	OK <CR> (Write to non-volatile memory)
ATCN <Enter>	OK <CR> (Exit Command Mode)

Method 2 (Multiple commands on one line)

Send AT Command	System Response
+++	OK <CR> (Enter into Command Mode)
ATDT <Enter>	{current value} <CR> (Read Destination Address)
ATDT1A0D,WR,CN <Enter>	OK <CR> (Execute commands)

Note: Do not send commands to the module during flash programming (when parameters are being written to the module registry). Wait for the "OK" system response that follows the ATWR command before entering the next command or use flow control.

Note: When using X-CTU Software to program a module, PC com port settings must match the baud (interface data rate), parity & stop bits parameter settings of the module. Use the 'Com Port Setup' section of the "PC Settings" tab to configure PC com port settings to match those of the module.

3.1.2. Binary Commands

To Send Binary Commands

Example: Use binary commands to change the XBee module's destination address to 0x1A0D and save the new address to non-volatile memory.

1. RT Command must be set to "1" in AT Command Mode to enable binary programming.
2. Assert CMD (Pin 16 is driven high). (Enter Binary Command Mode)
3. Send Bytes (parameter bytes must be 2 bytes long):

00	(Send DT (Destination Address) Command)
0D	(Least significant byte of parameter bytes)
1A	(Most significant byte of parameter bytes)
08	(Send WR (Write) Command)
4. De-assert CMD (Pin 16 is driven low)	(Exit Binary Command Mode)

Note: \overline{CTS} is de-asserted high when commands are being executed. Hardware flow control must be disabled as CTS will hold off parameter bytes.

3.2. Command Reference Table

Table 3-01. AT Commands (The RF Module expects numerical values in hexadecimal. "d" denotes decimal equivalent.)

AT Command	Binary Command	AT Command Name	Range	Command Category	# Bytes Returned	Factory Default
AT	0x05 (5d)	Guard Time After	0x02 – 0xFFFF [x 100 msec]	Command Mode Options	2	0x0A (10d)
BD	0x15 (21d)	Interface Data Rate	Standard baud rates: 0 – 6 Non-standard baud rates: 0x7D – 0xFFFF	Serial Interfacing	2	0x03 9600bps
BT	0x04 (4d)	Guard Time Before	2 – 0xFFFF [x 100 msec]	Command Mode Options	2	0x0A (10d)
CC	0x13 (19d)	Command Sequence Character	0x20 – 0x7F	Command Mode Options	1	0x2B ("+")
CD	0x28 (40d)	DO3 Configuration	0 - 4	Serial Interfacing	1	0
CN	0x09 (9d)	Exit AT Command Mode	-	Command Mode Options	-	-
CS	0x1F (31d)	DO2 Configuration	0 – 4	Serial Interfacing	1	0
CT	0x06 (6d)	Command Mode Timeout	0x02 – 0xFFFF [x 100 msec]	Command Mode Options	2	0xC8 (200d)
DB		RSSI level in dBm of the most recent packet	0 - 0x70 [read-only]	Diagnostics		1
DT	0x00 (0d)	Destination Address	0 – 0xFFFF	Networking	2	0
E0	0x0A (10d)	Echo Off	-	Command Mode Options	-	-
E1	0x0B (11d)	Echo On	-	Command Mode Options	-	-
ER	0x0F (15d)	Receive Error Count	0 – 0xFFFF	Diagnostics	2	0
FH	0x0D (13d)	Force Wake-up Initializer	-	Sleep (Low Power)	-	-
FL	0x07 (7d)	Software Flow Control	0 – 1	Serial Interfacing	1	0
FR		Forces the module to Reset		(Special)		
FT	0x24 (36d)	Flow Control Threshold	0 – (DI buffer – 0x11) [bytes]	Serial Interfacing	2	varies
GD	0x10 (16d)	Receive Good Count	0 – 0xFFFF	Diagnostics	2	0
HP	0x11 (17d)	Hopping Channel	0 – 6	Networking	1	0
HT	0x03 (3d)	Time before Wake-up Initializer	0 – 0xFFFF [x 100 msec]	Sleep (Low Power)	2	0xFFFF
ID	0x27 (39d)	Module VID	User settable: 0x10 - 0x7FFF Read-only: 0x8000 – 0xFFFF	Networking	2	-
LH	0x0C (12d)	Wake-up Initializer Timer	0 – 0xFF [x 100 msec]	Sleep (Low Power)	1	1
MK	0x12 (18d)	Address Mask	0 – 0xFFFF	Networking	2	0xFFFF
NB	0x23 (35d)	Parity	0 – 4	Serial Interfacing	1	0
PC	0x1E (30d)	Power-up Mode	0 – 1	Command Mode Options	1	0
PW	0x1D (29d)	Pin Wake-up	0 – 1	Sleep (Low Power)	1	0
RE	0x0E (14d)	Restore Defaults	-	(Special)	-	-
RN	0x19 (25d)	Delay Slots	0 – 0xFF [slots]	Networking	1	0
RO	0x21 (33d)	Packetization Timeout	0 – 0xFFFF [x 200 µsec]	Serial Interfacing	2	0
RP	0x22 (34d)	RSSI PWM Timer	0 - 0x7F [x 100 msec]	Diagnostics	1	0
RR	0x18 (24d)	Retries	0 – 0xFF	Networking	1	0
RS	0x1C (28d)	RSSI	0x06 – 0x36 [read-only]	Diagnostics	1	-
RT	0x16 (22d)	DI2 Configuration	0 - 2	Serial Interfacing	1	0
SB	0x36 (54d)	Stop Bits	0 - 1	Serial Interfacing	1	0
SH	0x25 (37d)	Serial Number High	0 – 0xFFFF [read-only]	Diagnostics	2	-
SL	0x26 (38d)	Serial Number Low	0 – 0xFFFF [read-only]	Diagnostics	2	-
SM	0x01 (1d)	Sleep Mode	0, 1, 3 - 8	Sleep (Low Power)	1	0
ST	0x02 (2d)	Time before Sleep	0x10 – 0xFFFF [x 100 msec]	Sleep (Low Power)	2	0x64 (100d)
SY	0x17 (23d)	Time before Initialization	0 – 0xFF [x 100 msec]	Networking	1	0 (disabled)
TR	0x1B (27d)	Transmit Error Count	0 – 0xFFFF	Diagnostics	2	0
TT	0x1A (26d)	Streaming Limit	0 – 0xFFFF [0 = disabled]	Networking	2	0xFFFF
VR	0x14 (20d)	Firmware Version	0 - 0xFFFF [read-only]	Diagnostics	2	-
WR	0x08 (8d)	Write	-	(Special)	-	-

.NOTE: AT Commands issued without a parameter value are interpreted as queries and will return the currently stored parameter.

3.3. Command Descriptions

Commands in this section are listed alphabetically. Command categories are designated between the "< >" symbols that follow each command title. Modules expect numerical values in hexadecimal and those values are designated by a "0x" prefix.

Modules operating within the same network should contain the same firmware platform to ensure the same AT Command parameters are supported.

AT (Guard Time After) Command

Command Summary	Description
AT Command: ATAT	<Command Mode Options> AT Command is used to set the time-of-silence that follows the command sequence character (CC Command). By default, AT Command Mode will activate after one second of silence. Refer to the AT Commands section [p] to view the default AT Command Mode Sequence.
Binary Command: 0x05 (5 decimal)	
Parameter Range: 0x02 - 0xFFFF [x 100 milliseconds]	
Number of bytes returned: 2	
Default Parameter Value: 0x0A (10 decimal)	
Related Commands: BT (Guard Time Before), CC (Command Sequence Character)	

BD (Interface Data Rate) Command

Command Summary	Description																
AT Command: ATBD	<Serial Interfacing> BD Command allows the user to adjust the UART interface data rate and thus modify the rate at which serial data is sent to the module. The new baud rate does not take effect until the CN (Exit AT Command Mode) Command is issued. The RF data rate is not affected by the BD Command. Although most applications will only require one of the seven standard baud rates, non-standard baud rates are also supported. <p>Note: If the serial data rate is set to exceed the fixed RF data rate of the module, flow control may need to be implemented as described in the Pin Signals and Flow Control sections of this manual.</p> <p>Non-standard Interface Data Rates: When parameter values outside the range of standard baud rates are sent, the closest interface data rate represented by the number is stored in the BD register. For example, a rate of 19200 bps can be set by sending the following command line "ATBD4B00". NOTE: When using X-CTU Software, non-standard interface data rates can only be set and read using the X-CTU 'Terminal' tab. Non-standard rates are not accessible through the 'Modem Configuration' tab.</p> <p>When the BD command is sent with a non-standard interface data rate, the UART will adjust to accommodate the requested interface rate. In most cases, the clock resolution will cause the stored BD parameter to vary from the parameter that was sent (refer to the table below). Reading the BD command (send "ATBD" command without an associated parameter value) will return the value that was actually stored to the BD register.</p>																
Binary Command: 0x15 (21 decimal)																	
Parameter Range (Standard baud rates): 0 - 6																	
(Non-standard baud rates): 0x7D - 0xFFFF (125d - 65535d)																	
<table border="1"> <thead> <tr> <th>Parameter Value</th> <th>BAUD (bps) Configuration</th> </tr> </thead> <tbody> <tr> <td>0</td> <td>1200</td> </tr> <tr> <td>1</td> <td>2400</td> </tr> <tr> <td>2</td> <td>4800</td> </tr> <tr> <td>3</td> <td>9600</td> </tr> <tr> <td>4</td> <td>19200</td> </tr> <tr> <td>5</td> <td>38400</td> </tr> <tr> <td>6</td> <td>57600</td> </tr> </tbody> </table>		Parameter Value	BAUD (bps) Configuration	0	1200	1	2400	2	4800	3	9600	4	19200	5	38400	6	57600
Parameter Value		BAUD (bps) Configuration															
0		1200															
1		2400															
2		4800															
3		9600															
4	19200																
5	38400																
6	57600																
Number of bytes returned: 2																	
Default Parameter Value: Set to equal module's factory-set RF data rate.																	

Table 3-02. Parameter Sent vs. Parameter Stored

BD Parameter Sent (HEX)	Interface Data Rate (bps)	BD Parameter Stored (HEX)
0	1200	0
4	19,200	4
6	57600	6
12C	300	12B
E100	57600	E883

BT (Guard Time Before) Command

Command Summary	Description
AT Command: ATBT	<Command Mode Options> BT Command is used to set the DI pin silence time that must precede the command sequence character (CC Command) of the AT Command Mode Sequence. Refer to the AT Commands section [p] to view the default AT Command Mode Sequence.
Binary Command: 0x04 (4 decimal)	
Parameter Range: 2 - 0xFFFF [x 100 milliseconds]	
Default Parameter Value: 0x0A (10 decimal)	
Number of bytes returned: 2	
Related Commands: AT (Guard Time After), CC (Command Sequence Character)	

CC (Command Sequence Character) Command

Command Summary	Description
AT Command: ATCC	<Command Mode Options> CC Command is used to set the ASCII character to be used between Guard Times of the AT Command Mode Sequence (BT+ CC + AT). The AT Command Mode Sequence activates AT Command Mode (from Idle Mode). Refer to the AT Commands section [p] to view the default AT Command Mode Sequence.
Binary Command: 0x13 (19 decimal)	
Parameter Range: 0x20 - 0x7F	
Default Parameter Value: 0x2B (ASCII "+") sign)	
Number of bytes returned: 1	
Related Commands: AT (Guard Time After), BT (Guard Time Before)	

CD (DO3 Configuration) Command

		Description
AT Command: ATCD		<Command Mode Options> CD Command is used to define the behavior of the DO3/RX LED line.
Binary Command: 0x28 (40 decimal)		
Parameter Range: 0 - 3		
Parameter Value	Configuration	
0	RX LED	
1	Default high	
2	Default low	
3	(reserved)	
4	Assert only when packet addressed to module is sent	
Default Parameter Value: 0		
Number of bytes returned: 1		

CN (Exit AT Command Mode) Command

Command Summary	Description
AT Command: ATCN	<Command Mode Options> CN Command is used to explicitly exit AT Command Mode.
Binary Command: 0x09 (9 decimal)	

CS (DO2 Configuration) Command

Command Summary	Description												
AT Command: ATCS	<Serial Interfacing> CS Command is used to select the behavior of the DO2 pin signal. This output can provide RS-232 flow control, control the TX enable signal (for RS-485 or RS-422 operations), or set the default level for the I/O line passing function. By default, DO2 provides RS-232 CTS (Clear-to-Send) flow control.												
Binary Command: 0x1F (31 decimal)													
Parameter Range: 0 - 4													
<table border="1"> <thead> <tr> <th>Parameter Value</th> <th>Configuration</th> </tr> </thead> <tbody> <tr> <td>0</td> <td>RS-232 CTS flow control</td> </tr> <tr> <td>1</td> <td>RS-485 TX enable low</td> </tr> <tr> <td>2</td> <td>high</td> </tr> <tr> <td>3</td> <td>RS-485 TX enable high</td> </tr> <tr> <td>4</td> <td>low</td> </tr> </tbody> </table>		Parameter Value	Configuration	0	RS-232 CTS flow control	1	RS-485 TX enable low	2	high	3	RS-485 TX enable high	4	low
Parameter Value		Configuration											
0	RS-232 CTS flow control												
1	RS-485 TX enable low												
2	high												
3	RS-485 TX enable high												
4	low												
Default Parameter Value: 0													
Number of bytes returned: 1													
Minimum Firmware Version Required: 4.27D													

CT (Command Mode Timeout) Command

Command Summary	Description
AT Command: ATCT	<Command Mode Options> CT Command sets the amount of time before AT Command Mode terminates automatically. After a CT time of inactivity, the module exits AT Command Mode and returns to Idle Mode. AT Command Mode can also be exited manually using CN (Exit AT Command Mode) Command.
Binary Command: 0x06 (6 decimal)	
Parameter Range: 0x02 - 0xFFFF [x 100 milliseconds]	
Default Parameter Value: 0xC8 (200 decimal, 20 seconds)	
Number of bytes returned: 2	

DB (RSSI in dBm) Command

Command Summary	Description
AT Command: ATDB	<Diagnostics> DB command returns the signal level of the last packet received in dBm. This reading is useful for determining range characteristics of the Modules under various conditions of noise and distance. Once the command is issued, the module will return the value in dBm. 0x32 (50d) = -50 dBm (strong signal), and 0x64 (100d) = -100 dBm (weak signal).
Binary Command: Not available	
Parameter Range: 00x00 to 0x70 [read-only]	
Number of bytes returned: returned: 1	
Related Commands: RS (RSSI Level)	

DT (Destination Address) Command

Command Summary	Description
AT Command: ATDT	<Networking> DT Command is used to set the networking address of a Module. Modules use three network layers – Vendor Identification Number (ATID), Channels (ATHP), and Destination Addresses (ATDT). DT Command assigns an address to a module that enables it to communicate only with other modules having the same addresses. All modules that share the same Destination Address can communicate freely with each other. Modules in the same network with a different Destination Address (than that of the transmitter) will listen to all transmissions to stay synchronized, but will not send any of the data out their serial ports.
Binary Command: 0x00	
Parameter Range: 0 – 0xFFFF	
Default Parameter Value: 0	
Number of bytes returned: 2	
Related Commands: HP (Hopping Channel), ID (Module VID), MK (Address Mask)	

E0 (Echo Off) Command

Command Summary	Description
AT Command: ATE0	<Command Mode Options> E0 Command turns off character echo in AT Command Mode. By default, echo is off.
Binary Command: 0x0A (10 decimal)	

E1 (Echo On) Command

Command Summary	Description
AT Command: ATE1	<Command Mode Options> E1 Command turns on the echo in AT Command Mode. Each typed character will be echoed back to the terminal when ATE1 is active. E0 is the default.
Binary Command: 0x0B (11 decimal)	

ER (Receive Error Count) Command

Command Summary	Description
AT Command: ATER	<Diagnostics> Set/Read the receive-error. The error-count records the number of packets partially received then aborted on a reception error. This value returns to 0 after a reset and is not non-volatile (Value does not persist in the module's memory after a power-up sequence). Once the "Receive Error Count" reaches its maximum value (up to 0xFFFF), it remains at its maximum count value until the maximum count value is explicitly changed or the module is reset.
Binary Command: 0x0F (15 decimal)	
Parameter Range: 0 - 0xFFFF	
Default Parameter Value: 0	
Number of bytes returned: 2	
Related Commands: GD (Receive Good Count)	

FH (Force Wake-up Initializer) Command

Command Summary	Description
AT Command: ATFH	<Sleep (Low Power)> FH Command is used to force a Wake-up Initializer to be sent on the next transmit. WR (Write) Command does not need to be issued with FH Command. Use only with cyclic sleep modes active on remote modules.
Binary Command: 0x0D (13 decimal)	

FL (Software Flow Control) Command

Command Summary

AT Command: ATFL
 Binary Command: 0x07 (7 decimal)
 Parameter Range: 0 - 1

Parameter Value	Configuration
0	Disable software flow control
1	Enable software flow control

 Default Parameter Value: 0
 Number of bytes returned: 1

Description

<Serial Interfacing> FL Command is used to configure software flow control. Hardware flow control is implemented with the Module as the DO2 pin (), which regulates when serial data can be transferred to the module. FL Command can be used to allow software flow control to also be enabled. XON character used is 0x11 (17 decimal). XOFF character used is 0x13 (19 decimal).

FR (Force Reset) Command

Command Summary

AT Command: ATFR
 Binary Command: Not available

Description

<Special> FR command is used in order to reset the module through the UART. The characters "OK" <CR> will be returned and the module will reset 100ms

FT (Flow Control Threshold) Command

Command Summary

AT Command: ATFT
 Binary Command: 0x24 (36 decimal)
 Parameter Range: 0 - (DI buffer size minus 0x11 bytes)
 Default Parameter Value: DI Buffer size minus 0x11 (17 decimal)
 Number of bytes returned: 2
 Minimum Firmware Version Required: 4.27B

Description

<Serial Interfacing> Flow Control Threshold - Set or read flow control threshold. De-assert CTS and/or send XOFF when FT bytes are in the UART receive buffer. Re-assert CTS when less than FT - 16 bytes are in the UART receive buffer.

GD (Receive Good Count) Command

Command Summary	Description
AT Command: ATGD	
Binary Command: 0x10 (16 decimal)	<Diagnostics> Set/Read the count of good received RF packets. Parameter value is reset to 0 after every reset and is not non-volatile (Value does not persist in the module's memory after a power-up sequence). Once the "Receive Good Count" reaches its maximum value (up to 0xFFFF), it remains at its maximum count value until the maximum count value is manually changed or the module is reset.
Parameter Range: 0 – 0xFFFF	
Default Parameter Value: 0	
Number of bytes returned: 2	
Related Commands: ER (Receive Error Count)	

HP (Hopping Channel) Command

Command Summary	Description
AT Command: ATHP	<Networking> HP Command is used to set the module's hopping channel number. A channel is one of three layers of addressing available to the module. In order for modules to communicate with each other, the modules must have the same channel number since each network uses a different hopping sequence. Different channels can be used to prevent modules in one network from listening to transmissions of another.
Binary Command: 0x11 (17 decimal)	
Parameter Range: 0 – 6	
Default Parameter Value: 0	
Number of bytes returned: 1	
Related Commands: DT (Destination Address), ID (Module VID), MK (Address Mask)	

HT (Time before Wake-up Initializer) Command

Command Summary	Description
AT Command: ATHT	<p><Sleep (Low Power)> If any modules within range are running in a “CyclicSleep” setting, a wake-up initializer must be used by the transmitting module for sleeping modules to remain awake [refer to the LH (“Wake-up InitializerTimer”) Command]. When a receiving module in Cyclic Sleep wakes, it must detect the wake-up initializer in order to remain awake and receive data. The value of HT Parameter tells the transmitter, “After a period of inactivity (no transmitting or receiving) lasting HT amount of time, send a long wake-up initializer”. HT Parameter should be set to match the inactivity timeout [specified by ST (Time before Sleep) Command] used by the receiver(s). From the receiving module perspective, after HT time elapses and the inactivity timeout [ST Command] is met, the receiver goes into cyclic sleep. In cyclic sleep, the receiver wakes once per sleep interval to check for a wakeup initializer. When a wake-up initializer is detected, the module will stay awake to receive data. The wake-up initializer must be longer than the cyclic sleep interval to ensure that sleeping modules detect incoming data. When HT time elapses, the transmitter then knows that it needs to send a long Wake-up Initializer for all receivers to be able to remain awake and receive the next transmission. Matching HT to the time specified by ST on the receiving module guarantees that all receivers will detect the next transmission.</p>
Binary Command: 0x03 (3 decimal)	
Parameter Range: 0 – 0xFFFF [x 100 milliseconds]	
Default Parameter Value: 0xFFFF (means that long wake-up initializer will not be sent)	
Number of bytes returned: 2	
Related Commands: LH (Wake-up Initializer Timer), SM (Sleep Mode), ST (Time before Sleep)	

ID (Modem VID) Command

Command Summary	Description
AT Command: ATID	<p><Networking> Set/Read the “Vendor Identification Number”. Only modems with matching IDs can communicate with each other. Modules with nonmatching VIDs will not receive unintended data transmission.</p>
Binary Command: 0x27 (39 decimal)	
Parameter Range (user-settable): 0x10 – 0x7FFF (Factory-set and read-only): 0x8000 – 0xFFFF	
Number of bytes returned: 2	

LH (Wake-up Initializer Timer) Command

Command Summary	Description
AT Command: ATLH	<p><Sleep (Low Power)> LH Command adjusts the duration of time for which the RF initializer is sent. When receiving modules are put into Cyclic Sleep Mode, they power-down after a period of inactivity [specified by ST (Time before Sleep) Command] and will periodically awaken and listen for transmitted data. In order for the receiving modules to remain awake, they must detect ~35ms of the wake-up initializer. LH Command must be used whenever a receiver is operating in Cyclic Sleep Mode. This lengthens the Wake-up Initializer to a specific amount of time (in tenths of a second). The Wake-up Initializer Time must be longer than the cyclic sleep time that is determined by SM (Sleep Mode) Command. If the wake-up initializer time were less than the Cyclic Sleep interval, the connection would be at risk of missing the wake-up initializer transmission. Refer to Figures 3.1 & 3.2 of the SM Command description to view diagrams of correct and incorrect configurations. The images help visualize the importance that the value of LH be greater than the value of SM.</p>
Binary Command: 0x0C (12 decimal)	
Parameter Range: 0 – 0xFF [x 100 milliseconds]	
Default Parameter Value: 1	
Number of bytes returned: 1	
Related Commands: HT (Time before Wake-up Initializer), SM (Sleep Mode), ST (Time before Sleep)	

MK (Address Mask) Command

Command Summary	Description
AT Command: ATMK	<p><Networking> MK Command is used to set/read the Address Mask. All data packets contain the Destination Address of the transmitting module. When an RF data packet is received, the transmitter’s Destination Address is logically “ANDed” (bitwise) with the Address Mask of the receiver. The resulting value must match the Destination Address or the Address Mask of the receiver for the packet to be received and sent out the module’s DO serial port. If the “ANDed” value does not match either the Destination Address or the Address Mask of the receiver, the packet is discarded. (All “0” values are treated as “irrelevant” values and are ignored.)</p>
Binary Command: 0x12 (18 decimal)	
Parameter Range: 0 – 0xFFFF	
Default Parameter Value: 0xFFFF (Destination address (DT parameter) of the transmitting module must exactly match the destination address of the receiving module.)	
Number of bytes returned: 2	
Related Commands: DT (Destination Address), HP (Hopping Channel), ID (Module VID)	

NB (Parity) Command

Command Summary

AT Command: ATNB

Binary Command: 0x23 (35 decimal)

Parameter Range: 0 - 4

Parameter Value	Configuration
0	8-bit (no parity or 7-bit (any parity))
1	8-bit even
2	8-bit odd
3	8-bit mark
4	8-bit space

Default Parameter Value: 0

Number of bytes returned: 1

Description

<Serial Interfacing>

Select/Read parity settings for UART communications.

PC (Power-up to AT Mode) Command

Command Summary

AT Command: ATPC

Binary Command: 0x1E (30 decimal)

Parameter Range: 0 - 1

Parameter Value	Configuration
0	Power-up to Idle Mode
1	Power-up to AT Command Mode

Default Parameter Value: 0

Number of bytes returned: 1

Description

<Command Mode Options> PC

Command allows the module to power-up directly into AT Command Mode from reset or power-on. If PC Command is enabled with SM Parameter set to 1, DI3 (pin 2) can be used to enter the module into AT Command Mode. When the DI3 pin is de-asserted (low), the module will wake-up in AT Command Mode. This behavior allows module DTR emulation.

PW (Pin Wake-up) Command

Command Summary

AT Command: ATPW
 Binary Command: 0x1D (29 decimal)
 Parameter Range: 0 - 1

Parameter Value	Configuration
0	Disabled
1	Enabled

Default Parameter Value: 0
 Number of bytes returned: 1
 Related Commands: SM (Sleep Mode), ST (Time before Sleep)

Description

<Sleep (Low Power)> Under normal operation, a module in Cyclic Sleep Mode cycles from an active state to a low-power state at regular intervals until data is ready to be received. If the PW Parameter is set to 1, SLEEP (pin 2) can be used to wake the module from Cyclic Sleep. If the SLEEP pin is de-asserted (low), the module will be fully operational and will not go into Cyclic Sleep. Once SLEEP is asserted, the module will remain active for the period of time specified by ST (Time before Sleep) Command, and will return to Cyclic Sleep Mode (if no data is ready to be transmitted). PW Command is only valid if Cyclic Sleep has been enabled.

RE (Restore Defaults) Command

Command Summary

AT Command: ATRE
 Binary Command: 0x0E (14 decimal)

Description

<Diagnostics> RE Command restores all configurable parameters to factory default settings. However, RE Command will not write the default values to non-volatile (persistent) memory. Unless the WR (Write) Command is issued after the RE command, the default settings will not be saved in the event of module reset or power-down.

RN (Delay Slots) Command

Command Summary

AT Command: ATRN
 Binary Command: 0x19 (25 decimal)
 Parameter Range: 0 - 0xFF [slots]
 Default Parameter Value: 0 (no delay slots inserted)
 Number of bytes returned: 1

Description

<Networking> RN Command is only applicable if retries have been enabled [RR (Retries) Command], or if forced delays will be inserted into a transmission [refer to TT (Streaming Limit) Command]. RN Command is used to adjust the time delay that the transmitter inserts before attempting to resend a packet. If the transmitter fails to receive an acknowledgement after sending a packet, it will insert a random number of delay slots (ranging from 0 to (RN minus 1)) before attempting to resend the packet. Each delay slot lasts for a period of 38ms. If two modules attempted to transmit at the same time, the random time delay after packet failure would allow one of the two modules to transmit the packet successfully, while the other would wait until the channel opens up to begin transmission.

RO (Packetization Timeout) Command

Command Summary	Description
AT Command: ATRO	<Serial Interfacing> RO Command is used to specify/read the time of silence (no bytes received) after which transmission begins. After a serial byte is received and if no other byte is received before the RO timeout, the transmission will start.
Binary Command: 0x21 (33 decimal)	
Parameter Range: 0 - 0xFFFF [x 200 μs]	
Default Parameter Value: 0	
Number of bytes returned: 2	

RP (RSSI PWM Timer) Command

Command Summary	Description
AT Command: ATRP	<Diagnostics> RP Command is used to enable a PWM (“Pulse Width Modulation”) output on the Config pin which is calibrated to show the level the received RF signal is above the sensitivity level of the module. The PWM pulses vary from zero to 95 percent. Zero percent means the received RF signal is at or below the published sensitivity level of the module. The following table shows levels above sensitivity and PWM values. The total period of the PWM output is 8.32 ms. There are 40 steps in the PWM output and therefore the minimum step size is 0.208 ms.
Binary Command: 0x22 (34 decimal)	
Parameter Range: 0 - 0x7F [x 100 milliseconds]	
Default Parameter Value: 0 (disabled)	
Number of bytes returned: 1	

Table 3-03. PWM Chart

dBm above Sensitivity	PWM percentage (high period / total period)
10	47.5 %
20	62.5 %
30	77.5 %

A non-zero value defines the time that the PWM output will be active with the RSSI value of the last received RF packet. After the set time when no RF packets are received, the PWM output will be set low (0 percent PWM) until another RF packet is received. The PWM output will also be set low at power-up. A parameter value of 0xFF permanently enables the PWM output and it will always reflect the value of the last received RF packet.

PWM output shares the Config input pin. When the module is powered, the Config pin will be an input. During the power-up sequence, the Config pin will be read to determine whether the module is going into AT Command Mode. After this, if RP parameter is a non-zero value, the Config pin will be configured as an output and set low until the first RF packet is received. With a non-zero RP parameter, the Config pin will be an input for RP ms after power up.

RR (Retries) Command

Command Summary	Description
AT Command: ATRR	<p>Networking> RR Command specifies the number of retries that can be sent for a given RF packet. Once RR Command is enabled (set to a non-zero value), RF packet acknowledgements and retries are enabled. After transmitting a packet, the transmitter will wait to receive an acknowledgement from a receiver. If the acknowledgement is not received in the period of time specified by the RN (Delay Slots) Command, the transmitter will transmit the original packet again. The packet will be transmitted repeatedly until an acknowledgement is received or until the packet has been sent RR times.</p> <p>Note: For retries to work correctly, all modules in the system must have retries enabled.</p>
Binary Command: 0x18 (24 decimal)	
Parameter Range: 0 - 0xFF	
Default Parameter Value: 0 (disabled)	
Number of bytes returned: 1	

RS (RSSI) Command

Command Summary	Description
AT Command: ATRS	<p><Diagnostics> RS Command returns the signal level of the last packet received. This reading is useful for determining range characteristics of the modules under various conditions of noise and distance.</p> <p>Once the command is issued, the module will return a value between 0x6 and 0x36 where 0x36 represents a very strong signal level and 0x4 indicates a low signal level.</p>
Binary Command: 0x1C (28 decimal)	
Parameter Range: 0x06 - 0x36 [read-only]	
Number of bytes returned: 1	

RT (DI2 Configuration) Command

Command Summary

AT Command: ATRT

Binary Command: 0x16 (22 decimal)

Parameter Range: 0 - 2

Parameter Value	Configuration
0	disabled
1	Enable Binary Programming
2	Enable RTS Flow Control

Default Parameter Value: 0

Number of bytes returned: 1

Description

<Serial Interfacing> RT command is used to dictate the behavior of the DI2/RTS/CMD line. RT Command must be issued to enable RTS flow control or binary programming.

SB (Stop Bits) Command

Command Summary

AT Command: ATSB

Binary Command: 0x36 (54 decimal)

Parameter Range: 0 - 1

Parameter Value	Configuration
0	1 stop bits
1	2 stop bits

Default Parameter Value: 0

Number of bytes returned: 1

Description

SB Command is used to set/read the number of stop bits in the data packets.

SH (Serial Number High) Command

Command Summary

AT Command: ATSH

Binary Command: 0x25 (37 decimal)

Parameter Range: 0 - 0xFFFF [read-only]

Number of bytes returned: 2

Related Commands: SL (Serial Number Low)

Description

<Diagnostics> Read the serial number high word of the module.

SL (Serial Number Low) Command

Command Summary

AT Command: ATSL

Binary Command: 0x26 (38 decimal)

Parameter Range: 0 - 0xFFFF [read-only]

Number of bytes returned: 2

Related Commands: SH (Serial Number High)

Description

<Diagnostics> Read the serial number low word of the module.

SM (Sleep Mode) Command

Command Summary

AT Command: ATSM

Binary Command: 0x01

Parameter Range: 0, 1 3-8

Parameter Value	Configuration
0	Disabled
1	Pin Sleep
3	Cyclic 0.5 second sleep (Module wakes every 0.5 seconds)
4	Cyclic 1.0 second sleep
5	Cyclic 2.0 second sleep
6	Cyclic 4.0 second sleep
7	Cyclic 8.0 second sleep
8	Cyclic 16.0 second sleep

Default Parameter Value: 0

Number of bytes returned: 1

Related Commands:

For Pin Sleep – PC (Power-up Mode), PW (Pin Wake-up)

For Serial Port Sleep – ST (Time before Sleep)

For Cyclic Sleep – ST (Time before Sleep), LH (Wake-up Initializer Timer), HT (Time Before Wake-up Initializer), PW (Pin Wake-up)

Description

<Sleep Mode (Low Power)> SM Command is used to adjust Sleep Mode settings. By default, Sleep Mode is disabled and the module remains continually active. SM Command allows the module to run in a lower-power state and be configured in one of eight settings. Cyclic Sleep settings wake the module after the amount of time designated by SM Command. If the module detects a wake-up initializer during the time it is awake, it will synchronize with the transmitter and start receiving data after the wake-up initializer runs its duration. Otherwise, it returns to Sleep Mode and continue to cycle in and out of inactivity until the Wake-up Initializer is detected. If a Cyclic Sleep setting is chosen, the ST, LH and HT parameters must also be set as described in the “Sleep Mode” section of this manual.

ST (Time before Sleep) Command

Command Summary

AT Command: ATST

Binary Command: 0x02

Parameter Range: 0x10 - 0xFFFF [x 100 milliseconds]

Default Parameter Value: 0x64 (100 decimal)

Number of bytes returned: 2

Related Commands: SM (Sleep Mode), LH (Wake-up Initializer Timer), HT (Time before Wake-up Initializer)

Description

<Sleep Mode (Low Power)> ST Command sets the period of time (in tenths of seconds) in which the module remains inactive before entering into Sleep Mode. For example, if the ST Parameter is set to 0x64 (100 decimal), the module will enter into Sleep mode after 10 seconds of inactivity (no transmitting or receiving). This command can only be used if Cyclic Sleep or Serial Port Sleep Mode settings have been selected using SM (Sleep Mode) Command.

SY (Time before Initialization) Command

Command Summary	Description
AT Command: ATSY	<p><Networking> SY Command keeps a communication channel open as long as module transmits or receives before the active connection expires. It can be used to reduce latency in a query/response sequence and should be set 100 ms longer than the delay between transmissions. This command allows multiple Modules to share a hopping channel for a given amount of time after receiving data. By default, all packets include an RF initializer that contains channel information used to synchronize any listening receivers to the transmitter’s hopping pattern. Once a new module comes within range, it is able to instantly synchronize to the transmitter and start receiving data. If no new modules are introduced into the system, the synchronization information becomes redundant once modules have become synchronized.</p> <p>SY Command allows the modules to remove this information from the RF Initializer after the initial synchronization. For example, changing the SY Parameter to 0x14 (20 decimal) allows all modules to remain in sync for 2 seconds after the last data packet was received. Synchronization information is not re-sent unless transmission stops for more than 2 seconds. This command allows significant savings in packet transmission time.</p> <p>Warning: Not recommended for use in an interference-prone environment. Interference can break up the session and the communications channel will not be available again until SY time expires. With SY set to zero, the channel session is opened and closed with each transmission – resulting in a more robust link with more latency.</p>
Binary Command: 0x17 (23 decimal)	
Parameter Range: 0 – 0xFF [x 100 milliseconds]	
Default Parameter Value: 0 (Disabled – channel initialization information is sent with each RF packet.)	
Number of bytes returned: 1	

TR (Transmit Error Count) Command

Command Summary	Description
AT Command: ATTR	<p><Diagnostics> TR Command records the number of retransmit failures. This number is incremented each time a packet is not acknowledged within the number of retransmits specified by the RR (Retries) Command. It therefore counts the number of packets that were not successfully received and have been dropped. The TR Parameter is not non-volatile and will therefore be reset to zero each time the module is reset.</p>
Binary Command: 0x1B (27 decimal)	
Parameter Range: 0 – 0xFFFF	
Default Parameter Value: 0	
Number of bytes returned: 2	
Related Commands: RR (Retries)	

TT (Streaming Limit) Command

Command Summary	Description
AT Command: ATTT	<p data-bbox="657 260 1131 394"><Networking> TT Command defines a limit on the number of bytes that can be sent out before a random delay is issued. TT Command is used to simulate full-duplex behavior.</p> <p data-bbox="657 401 1131 646">If a module is sending a continuous stream of RF data, a delay is inserted which stops its transmission and allows other modules time to transmit (once it sends number of bytes specified by TT Command). Inserted random delay lasts between 1 & 'RN + 1' delay slots, where each delay slot lasts 38 ms.</p>
Binary Command: 0x1A (26 decimal)	
Parameter Range: 0 - 0xFFFF (0 = disabled)	
Default Parameter Value: 0xFFFF (65535 decimal)	
Number of bytes returned: 2	
Related Commands: RN (Delay Slots)	

Appendix A: Agency Certifications

FCC (United States) Certification

The XBee-PRO® XSC OEM RF Module complies with Part 15 of the FCC rules and regulations. Compliance with the labeling requirements, FCC notices and antenna usage guidelines is required.

In order to operate under Digi's FCC Certification, OEMs/integrators must comply with the following regulations:

1. The system integrator must ensure that the text provided with this device [Figure A-01] is placed on the outside of the final product and within the final product operation manual.
2. The XBee-PRO® XSC OEM RF Module may only be used with antennas that have been tested and approved for use with this module Refer to Table A-1.

Labeling Requirements



WARNING: The Original Equipment Manufacturer (OEM) must ensure that FCC labeling requirements are met. This includes a clearly visible label on the outside of the final product enclosure that displays the text shown in the figure below.

Figure A-01. Required FCC Label for OEM products containing the XBee-PRO® XSC OEM RF Module

Contains FCC ID: MCQ-XBEEEXSC

The enclosed device complies with Part 15 of the FCC Rules. Operation is subject to the following two conditions: (i.) this device may not cause harmful interference and (ii.) this device must accept any interference received, including interference that may cause undesired operation.

FCC Notices

IMPORTANT: The XBee-PRO® XSC OEM RF Module has been certified by the FCC for use with other products without any further certification (as per FCC section 2.1091). Modifications not expressly approved by Digi could void the user's authority to operate the equipment.

IMPORTANT: OEMs must test final product to comply with unintentional radiators (FCC section 15.107 & 15.109) before declaring compliance of their final product to Part 15 of the FCC Rules.

IMPORTANT: The RF module has been certified for remote and base radio applications. If the module will be used for portable applications, the device must undergo SAR testing.

This equipment has been tested and found to comply with the limits for a Class B digital device, pursuant to Part 15 of the FCC Rules. These limits are designed to provide reasonable protection against harmful interference in a residential installation. This equipment generates, uses and can radiate radio frequency energy and, if not installed and used in accordance with the instructions, may cause harmful interference to radio communications. However, there is no guarantee that interference will not occur in a particular installation.

If this equipment does cause harmful interference to radio or television reception, which can be determined by turning the equipment off and on, the user is encouraged to try to correct the interference by one or more of the following measures: Re-orient or relocate the receiving antenna, Increase the separation between the equipment and receiver, Connect equipment and receiver to outlets on different circuits, or Consult the dealer or an experienced radio/TV technician for help.

Limited Modular Approval

This is an RF module approved for Limited Modular use operating as a mobile transmitting device with respect to section 2.1091 and is limited to OEM installation for Mobile and Fixed applications only. During final installation, end-users are prohibited from access to any programming parameters. Professional installation adjustment is required for setting module power and antenna gain to meet EIRP compliance for high gain antenna(s).

Final antenna installation and operating configurations of this transmitter including antenna gain and cable loss must not exceed the EIRP of the configuration used for calculating MPE. Grantee (Digi) must coordinate with OEM integrators to ensure the end-users and installers of products operating with the module are provided with operating instructions to satisfy RF exposure requirements.

The FCC grant is valid only when the device is sold to OEM integrators. Integrators are instructed to ensure the end-user has no manual instructions to remove, adjust or install the device.

FCC-approved Antennas



WARNING: This device has been tested with Reverse Polarity SMA connectors with the antennas listed in the tables of this section. When integrated into OEM products, fixed antennas require installation preventing end-users from replacing them with non-approved antennas. Antennas not listed in the tables must be tested to comply with FCC Section 15.203 (unique antenna connectors) and Section 15.247 (emissions).

Fixed Base Station and Mobile Applications

Digi RF Modules are pre-FCC approved for use in fixed base station and mobile applications. When the antenna is mounted at least 20cm (8") from nearby persons, the application is considered a mobile application.

Portable Applications and SAR Testing

When the antenna is mounted closer than 20cm to nearby persons, then the application is considered "portable" and requires an additional test be performed on the final product. This test is called Specific Absorption Rate (SAR) testing and measures the emissions from the module and how they affect the person.

RF Exposure

This statement must be included as a CAUTION statement in OEM product manuals.



WARNING: This equipment is approved only for mobile and base station transmitting devices. Antenna(s) used for this transmitter must be installed to provide a separation distance of at least 20 cm from all persons and must not be co-located or operating in conjunction with any other antenna or transmitter.

IC (Industry Canada) Certification

Labeling requirements for Industry Canada are similar to those of the FCC. A clearly visible label on the outside of the final product enclosure must display the following text:

Contains Model: XBEEEXSC, IC: 1846A-XBEEEXSC

Integrator is responsible for its product to comply with IC ICES-003 & FCC Part 15, Sub. B - Unintentional Radiators. ICES-003 is the same as FCC Part 15 Sub. B and Industry Canada accepts FCC test report or CISPR 22 test report for compliance with ICES-003.

Transmitter Antennas

This device has been designed to operate with the antennas listed below, and having a maximum gain of 15.1 dB. Antennas not included in this list or having a gain greater than 15.1 dB are strictly prohibited for use with this device. The required antenna impedance is 50 ohms.

Operation is subject to the following two conditions: (1) this device may not cause interference, and (2) this device must accept any interference, including interference that may cause undesired operation of the device.

To reduce potential radio interference to other users, the antenna type and its gain should be so chosen that the equivalent isotropically radiated power (e.i.r.p.) is not more than that permitted for successful communication

Antenna Options: 900 MHz Antenna Listings

Table A-01. Antennas approved for use with the XBee-PRO XSC OEM RF Module

Part Number	Type	Connector	Gain	Application
Omni-directional antennas				
A09-F0	Fiberglass Base	RPN	0 dBi	Fixed
A09-F1	Fiberglass Base	RPN	1.0 dBi	Fixed
A09-F2	Fiberglass Base	RPN	2.1 dBi	Fixed
A09-F3	Fiberglass Base	RPN	3.1 dBi	Fixed
A09-F4	Fiberglass Base	RPN	4.1 dBi	Fixed
A09-F5	Fiberglass Base	RPN	5.1 dBi	Fixed
A09-F6	Fiberglass Base	RPN	6.1 dBi	Fixed
A09-F7	Fiberglass Base	RPN	7.1 dBi	Fixed
A09-F8	Fiberglass Base	RPN	8.1 dBi	Fixed
A09-F9	Base Station	RPSMAF	9.2dBi	Fixed
A09-W7	Wire Base Station	RPN	7.1 dBi	Fixed
A09-F0	Fiberglass Base	RPSMA	0 dBi	Fixed
A09-F1	Fiberglass Base	RPSMA	1.0 dBi	Fixed
A09-F2	Fiberglass Base	RPSMA	2.1 dBi	Fixed
A09-F3	Fiberglass Base	RPSMA	3.1 dBi	Fixed
A09-F4	Fiberglass Base	RPSMA	4.1 dBi	Fixed
A09-F5	Fiberglass Base	RPSMA	5.1 dBi	Fixed
A09-F6	Fiberglass Base	RPSMA	6.1 dBi	Fixed
A09-F7	Fiberglass Base	RPSMA	7.1 dBi	Fixed
A09-F8	Fiberglass Base	RPSMA	8.1 dBi	Fixed
A09-M7	Base Station	RPSMAF	7.2dBi	Fixed
A09-W7SM	Wire Base Station	RPSMA	7.1 dBi	Fixed
A09-F0TM	Fiberglass Base	RPTNC	0 dBi	Fixed
A09-F1TM	Fiberglass Base	RPTNC	1.0 dBi	Fixed
A09-F2TM	Fiberglass Base	RPTNC	2.1 dBi	Fixed
A09-F3TM	Fiberglass Base	RPTNC	3.1 dBi	Fixed
A09-F4TM	Fiberglass Base	RPTNC	4.1 dBi	Fixed
A09-F5TM	Fiberglass Base	RPTNC	5.1 dBi	Fixed
A09-F6TM	Fiberglass Base	RPTNC	6.1 dBi	Fixed
A09-F7TM	Fiberglass Base	RPTNC	7.1 dBi	Fixed
A09-F8TM	Fiberglass Base	RPTNC	8.1 dBi	Fixed
A09-W7TM	Wire Base Station	RPTNC	7.1 dBi	Fixed
A09-HSM-7	Straight half-wave	RPSMA	3.0 dBi	Fixed / Mobile
A09-HASM-675	Articulated half-	RPSMA	2.1 dBi	Fixed / Mobile
A09-HABMM-P6I	Articulated half-	MMCX	2.1 dBi	Fixed / Mobile
A09-HABMM-6-P6I	Articulated half-	MMCX	2.1 dBi	Fixed / Mobile
A09-HBMM-P6I	Straight half-wave	MMCX	2.1 dBi	Fixed / Mobile
A09-HRSM	Right angle half-	RPSMA	2.1 dBi	Fixed
A09-HASM-7	Articulated half-	RPSMA	2.1 dBi	Fixed
A09-HG	Glass mounted	RPSMA	2.1 dBi	Fixed
A09-HATM	Articulated half-	RPTNC	2.1 dBi	Fixed
A09-H	Half-wave dipole	RPSMA	2.1 dBi	Fixed
A09-HBMMP6I	1/2 wave antenna	MMCX	2.1dBi	Mobile

A09-QBMMP6I	1/4 wave antenna	MMCX	1.9 dBi	Mobile
A09-QI	1/4 wave integrated wire antenna	Integrated	1.9 dBi	Mobile
29000187	Helical	Integrated	-2.0 dBi	Fixed/Mobile
A09-QW	Quarter-wave wire	Permanent	1.9 dBi	Fixed / Mobile
A09-QRAMM	3 " Quarter-wave	MMCX	2.1 dBi	Fixed / Mobile
A09-QSM-3	Quarter-wave	RPSMA	1.9 dBi	Fixed / Mobile
A09-QSM-3H	Heavy duty quarter-	RPSMA	1.9 dBi	Fixed / Mobile
A09-QBMM-P6I	Quarter-wave w/ 6"	MMCX	1.9 dBi	Fixed / Mobile
A09-QHRN	Miniature Helical	Permanent	-1 dBi	Fixed / Mobile
A09-QHSN	Miniature Helical	Permanent	-1 dBi	Fixed / Mobile
A09-QHSM-2	2" Straight	RPSMA	1.9 dBi	Fixed / Mobile
A09-QHRSM-2	2" Right angle	RPSMA	1.9 dBi	Fixed / Mobile
A09-QHRSM-170	1.7" Right angle	RPSMA	1.9 dBi	Fixed / Mobile
A09-QRSM-380	3.8" Right angle	RPSMA	1.9 dBi	Fixed / Mobile
A09-QAPM-520	5.2" Articulated	Permanent	1.9 dBi	Fixed / Mobile
A09-QSPM-3	3" Straight screw	Permanent	1.9 dBi	Fixed / Mobile
A09-QAPM-3	3" Articulated screw	Permanent	1.9 dBi	Fixed / Mobile
A09-QAPM-3H	3" Articulated screw	Permanent	1.9 dBi	Fixed / Mobile
A09-DPSM-P12F	omni directional	RPSMA	3.0 dBi	Fixed
A09-D3NF-P12F	omni directional	RPN	3.0 dBi	Fixed
A09-D3SM-P12F	omni directional w/	RPSMA	3.0 dBi	Fixed
A09-D3PNF	omni directional	RPN	3.0 dBi	Fixed
A09-D3TM-P12F	omni directional w/	RPTNC	3.0 dBi	Fixed
A09-D3PTM	omni directional	RPTNC	3.0 dBi	Fixed
A09-M0SM	Mag Mount	RPSMA	0 dBi	Fixed
A09-M2SM	Mag Mount	RPSMA	2.1 dBi	Fixed
A09-M3SM	Mag Mount	RPSMA	3.1 dBi	Fixed
A09-M5SM	Mag Mount	RPSMA	5.1 dBi	Fixed
A09-M7SM	Mag Mount	RPSMA	7.1 dBi	Fixed
A09-M8SM	Mag Mount	RPSMA	8.1 dBi	Fixed
A09-M0TM	Mag Mount	RPTNC	0 dBi	Fixed
A09-M2TM	Mag Mount	RPTNC	2.1 dBi	Fixed
A09-M3TM	Mag Mount	RPTNC	3.1 dBi	Fixed
A09-M5TM	Mag Mount	RPTNC	5.1 dBi	Fixed
A09-M7TM	Mag Mount	RPTNC	7.1 dBi	Fixed
A09-M8TM	Mag Mount	RPTNC	8.1 dBi	Fixed
Yagi antennas				
A09-Y6	2 Element Yagi	RPN	6.1 dBi	Fixed / Mobile
A09-Y7	3 Element Yagi	RPN	7.1 dBi	Fixed / Mobile
A09-Y8	4 Element Yagi	RPN	8.1 dBi	Fixed / Mobile
A09-Y9	4 Element Yagi	RPN	9.1 dBi	Fixed / Mobile
A09-Y10	5 Element Yagi	RPN	10.1 dBi	Fixed / Mobile
A09-Y11	6 Element Yagi	RPN	11.1 dBi	Fixed / Mobile
A09-Y12	7 Element Yagi	RPN	12.1 dBi	Fixed / Mobile
A09-Y13	9 Element Yagi	RPN	13.1 dBi	Fixed / Mobile
A09-Y14	10 Element Yagi	RPN	14.1 dBi	Fixed / Mobile
A09-Y14	12 Element Yagi	RPN	14.1 dBi	Fixed / Mobile

A09-Y15	13 Element Yagi	RPN	15.1 dBi	Fixed / Mobile
A09-Y15	15 Element Yagi	RPN	15.1 dBi	Fixed / Mobile
A09-Y6TM	2 Element Yagi	RPTNC	6.1 dBi	Fixed / Mobile
A09-Y7TM	3 Element Yagi	RPTNC	7.1 dBi	Fixed / Mobile
A09-Y8TM	4 Element Yagi	RPTNC	8.1 dBi	Fixed / Mobile
A09-Y9TM	4 Element Yagi	RPTNC	9.1 dBi	Fixed / Mobile
A09-Y10TM	5 Element Yagi	RPTNC	10.1 dBi	Fixed / Mobile
A09-Y11TM	6 Element Yagi	RPTNC	11.1 dBi	Fixed / Mobile
A09-Y12TM	7 Element Yagi	RPTNC	12.1 dBi	Fixed / Mobile
A09-Y13TM	9 Element Yagi	RPTNC	13.1 dBi	Fixed / Mobile
A09-Y14TM	10 Element Yagi	RPTNC	14.1 dBi	Fixed / Mobile
A09-Y14TM	12 Element Yagi	RPTNC	14.1 dBi	Fixed / Mobile
A09-Y15TM	13 Element Yagi	RPTNC	15.1 dBi	Fixed / Mobile
A09-Y15TM	15 Element Yagi	RPTNC	15.1 dBi	Fixed / Mobile

Appendix B: Additional Information

1-Year Warranty

WARRANTY PERIOD: Digi warranties hardware Product for a period of one (1) year.

WARRANTY PROCEDURE: Upon return of the hardware Product Digi will, at its option, repair or replace Product at no additional charge, freight prepaid, except as set forth below. Repair parts and replacement Product will be furnished on an exchange basis and will be either reconditioned or new. All replaced Product and parts become the property of Digi. If Digi determines that the Product is not under warranty, it will, at the Customers option, repair the Product using current Digi standard rates for parts and labor, and return the Product UPS Ground at no charge in or out of warranty.

Ordering Information

Figure B-01. Module Part Number Matrix

X	B	P	0	9	-	D	M	W	I	T	-	1	5	6	
1	2	3				4	5	6	7			8			

1 Product Family

XB = XBee

2 Power / Range

P = PRO

Not used = Regular

3 Frequency

09 = 900 MHz

24 = 2.4 GHz

H9 = 915 MHz (Australia)

08 = 868 MHz (Europe)

4 Protocol

A = 802.15.4 (Series 1)

B = ZNet 2.5 (Series 2)

DM = DigiMesh

DP = Digi Point to Multipoint

XC = XStream Compatible

Z6 = ZigBee 2006

Z7 = ZigBee 2007

WF = WiFi (802.11)

5 Antenna Type

C = Chip

H = Helical

S = SMA

U = U.FL

W = Wire

N = None

6 Temperature Rating

C = Commercial

I = Industrial

T = Tested

7 Mount

T = Through-hole

S = Surface Mount (Not used currently)

Not used for XBee 802.15.4 (Series 1)

8 Variation

Baud, Firmware, Customer Specific Settings

When Protocol = DM, DP and XC

001 = 1200 bps

009 = 9600 bps

019 = 19200 bps

156 = 156000 bps

When Protocol = A, B, Z6 and Z7

001 = standard firmware for XBee 802.15.4 (Series 1)

004 = Router, AT for XBee ZNet2.5 (Series 2)

other firmware settings as needed

J at the end = International variant

Contact Digi

For the best in wireless data solutions and support, please use the following resources:

Technical Support:	Phone.	(801) 765-9885
	Live Chat.	www.digi.com
	Online Support.	http://www.digi.com/support/eservice/login.jsp