



2.5 V to 5.5 V, 500 μ A, Quad Voltage Output 8-/10-/12-Bit DACs in 10-Lead microSOIC

AD5304/AD5314/AD5324*

FEATURES

AD5304

Four Buffered 8-Bit DACs in 10-Lead microSOIC

AD5314

Four Buffered 10-Bit DACs in 10-Lead microSOIC

AD5324

Four Buffered 12-Bit DACs in 10-Lead microSOIC

Low Power Operation: 500 μ A @ 3 V, 600 μ A @ 5 V

2.5 V to 5.5 V Power Supply

Guaranteed Monotonic By Design Over All Codes

Power-Down to 80 nA @ 3 V, 200 nA @ 5 V

Double-Buffered Input Logic

Output Range: 0– V_{REF}

Power-On-Reset to Zero Volts

Simultaneous Update of Outputs (\overline{LDAC} Function)

Low Power, SPI™, QSPI™, MICROWIRE™, and

DSP-Compatible 3-Wire Serial Interface

On-Chip Rail-to-Rail Output Buffer Amplifiers

Temperature Range –40°C to +105°C

APPLICATIONS

Portable Battery-Powered Instruments

Digital Gain and Offset Adjustment

Programmable Voltage and Current Sources

Programmable Attenuators

Industrial Process Control

GENERAL DESCRIPTION

The AD5304/AD5314/AD5324 are quad 8-, 10- and 12-bit buffered voltage output DACs in a 10-lead microSOIC package that operate from a single 2.5 V to 5.5 V supply consuming 500 μ A at 3 V. Their on-chip output amplifiers allow rail-to-rail output swing to be achieved with a slew rate of 0.7 V/ μ s. A 3-wire serial interface is used which operates at clock rates up to 30 MHz and is compatible with standard SPI, QSPI, MICROWIRE and DSP interface standards.

The references for the four DACs are derived from one reference pin. The outputs of all DACs may be updated simultaneously using the software \overline{LDAC} function. The parts incorporate a power-on-reset circuit that ensures that the DAC outputs power up to zero volts and remain there until a valid write takes place to the device. The parts contain a power-down feature that reduces the current consumption of the device to 200 nA @ 5 V (80 nA @ 3 V).

The low power consumption of these parts in normal operation makes them ideally suited to portable battery-operated equipment. The power consumption is 3 mW at 5 V, 1.5 mW at 3 V, reducing to 1 μ W in power-down mode.

FUNCTIONAL BLOCK DIAGRAM

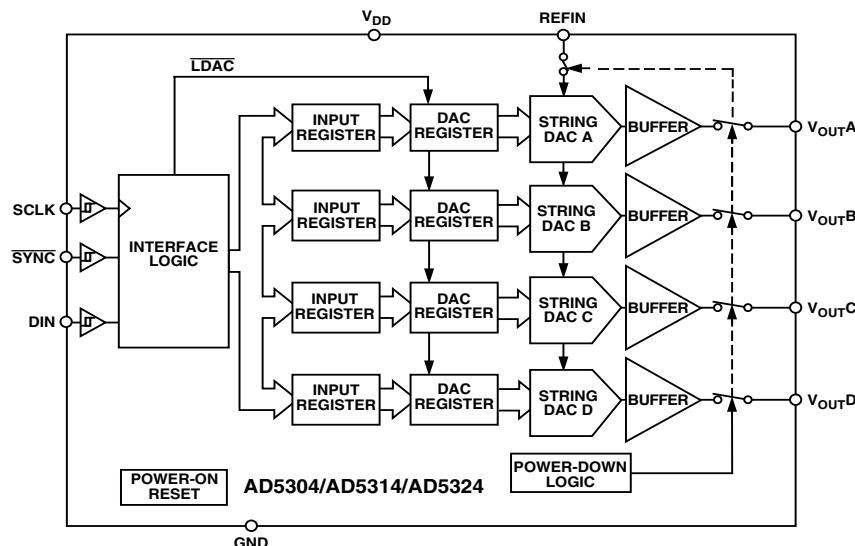

*Protected by U.S. Patent No. 5,969,657; other patents pending.

SPI and QSPI are trademarks of Motorola, Inc.

MICROWIRE is a trademark of National Semiconductor Corporation.

REV. B

Information furnished by Analog Devices is believed to be accurate and reliable. However, no responsibility is assumed by Analog Devices for its use, nor for any infringements of patents or other rights of third parties which may result from its use. No license is granted by implication or otherwise under any patent or patent rights of Analog Devices.

One Technology Way, P.O. Box 9106, Norwood, MA 02062-9106, U.S.A.
Tel: 781/329-4700 World Wide Web Site: <http://www.analog.com>
Fax: 781/326-8703 © Analog Devices, Inc., 2000

AD5304/AD5314/AD5324—SPECIFICATIONS

($V_{DD} = 2.5\text{ V to }5.5\text{ V}$; $V_{REF} = 2\text{ V}$; $R_L = 2\text{ k}\Omega$ to GND; $C_L = 200\text{ pF}$ to GND; All specifications T_{MIN} to T_{MAX} unless otherwise noted.)

Parameter ¹	B Version ²			Unit	Conditions/Comments
	Min	Typ	Max		
DC PERFORMANCE^{3, 4}					
AD5304					
Resolution		8		Bits	Guaranteed Monotonic by Design Over All Codes
Relative Accuracy		± 0.15	± 1	LSB	
Differential Nonlinearity		± 0.02	± 0.25	LSB	
AD5314					
Resolution		10		Bits	Guaranteed Monotonic by Design Over All Codes
Relative Accuracy		± 0.5	± 4	LSB	
Differential Nonlinearity		± 0.05	± 0.5	LSB	
AD5324					
Resolution		12		Bits	Guaranteed Monotonic by Design Over All Codes
Relative Accuracy		± 2	± 16	LSB	
Differential Nonlinearity		± 0.2	± 1	LSB	
Offset Error		± 0.4	± 3	% of FSR	See Figures 2 and 3
Gain Error		± 0.15	± 1	% of FSR	See Figures 2 and 3
Lower Deadband		20	60	mV	Lower Deadband Exists Only If Offset Error Is Negative
Offset Error Drift ⁵		-12		ppm of FSR/ $^{\circ}\text{C}$	$\Delta V_{DD} = \pm 10\%$ $R_L = 2\text{ k}\Omega$ to GND or V_{DD}
Gain Error Drift ⁵		-5		ppm of FSR/ $^{\circ}\text{C}$	
DC Power Supply Rejection Ratio ⁵		-60		dB	
DC Crosstalk ⁵		200		μV	
DAC REFERENCE INPUTS⁵					
V_{REF} Input Range	0.25		V_{DD}	V	Normal Operation Power-Down Mode Frequency = 10 kHz
V_{REF} Input Impedance	37	45		k Ω	
Reference Feedthrough		>10		M Ω	
		-90		dB	
OUTPUT CHARACTERISTICS⁵					
Minimum Output Voltage ⁶		0.001		V	This is a measure of the minimum and maximum drive capability of the output amplifier.
Maximum Output Voltage ⁶		$V_{DD} - 0.001$		V	
DC Output Impedance		0.5		Ω	$V_{DD} = 5\text{ V}$ $V_{DD} = 3\text{ V}$ Coming Out of Power-Down Mode. $V_{DD} = 5\text{ V}$ Coming Out of Power-Down Mode. $V_{DD} = 3\text{ V}$
Short Circuit Current		25		mA	
		16		mA	
Power-Up Time		2.5		μs	
		5		μs	
LOGIC INPUTS⁵					
Input Current			± 1	μA	$V_{DD} = 5\text{ V} \pm 10\%$ $V_{DD} = 3\text{ V} \pm 10\%$ $V_{DD} = 2.5\text{ V}$ $V_{DD} = 5\text{ V} \pm 10\%$ $V_{DD} = 3\text{ V} \pm 10\%$ $V_{DD} = 2.5\text{ V}$
V_{IL} Input Low Voltage			0.8	V	
			0.6	V	
			0.5	V	
V_{IH} Input High Voltage	2.4			V	
	2.1			V	
	2.0			V	
Pin Capacitance		3		pF	
POWER REQUIREMENTS					
V_{DD}	2.5		5.5	V	$V_{IH} = V_{DD}$ and $V_{IL} = \text{GND}$ $V_{IH} = V_{DD}$ and $V_{IL} = \text{GND}$
I_{DD} (Normal Mode) ⁷					
$V_{DD} = 4.5\text{ V to }5.5\text{ V}$		600	900	μA	
$V_{DD} = 2.5\text{ V to }3.6\text{ V}$		500	700	μA	
I_{DD} (Power-Down Mode)					$V_{IH} = V_{DD}$ and $V_{IL} = \text{GND}$ $V_{IH} = V_{DD}$ and $V_{IL} = \text{GND}$
$V_{DD} = 4.5\text{ V to }5.5\text{ V}$		0.2	1	μA	
$V_{DD} = 2.5\text{ V to }3.6\text{ V}$		0.08	1	μA	

NOTES

¹See Terminology.

²Temperature range: B Version: -40°C to $+105^{\circ}\text{C}$; typical at 25°C .

³DC specifications tested with the outputs unloaded.

⁴Linearity is tested using a reduced code range: AD5304 (Code 8 to 248); AD5314 (Code 28 to 995); AD5324 (Code 115 to 3981).

⁵Guaranteed by design and characterization, not production tested.

⁶In order for the amplifier output to reach its minimum voltage, Offset Error must be negative. In order for the amplifier output to reach its maximum voltage,

$V_{REF} = V_{DD}$ and "Offset plus Gain" Error must be positive.

⁷ I_{DD} specification is valid for all DAC codes. Interface inactive. All DACs active. Load currents excluded.

Specifications subject to change without notice.

AC CHARACTERISTICS¹ ($V_{DD} = 2.5\text{ V to }5.5\text{ V}$; $R_L = 2\text{ k}\Omega\text{ to GND}$; $C_L = 200\text{ pF to GND}$; all specifications T_{MIN} to T_{MAX} unless otherwise noted.)

Parameter ²	B Version ³			Unit	Conditions/Comments
	Min	Typ	Max		
Output Voltage Settling Time					$V_{REF} = V_{DD} = 5\text{ V}$
AD5304		6	8	μs	1/4 Scale to 3/4 Scale Change (40 Hex to C0 Hex)
AD5314		7	9	μs	1/4 Scale to 3/4 Scale Change (100 Hex to 300 Hex)
AD5324		8	10	μs	1/4 Scale to 3/4 Scale Change (400 Hex to C00 Hex)
Slew Rate		0.7		$\text{V}/\mu\text{s}$	
Major-Code Transition Glitch Energy		12		$\text{nV}\cdot\text{s}$	1 LSB Change Around Major Carry
Digital Feedthrough		1		$\text{nV}\cdot\text{s}$	
Digital Crosstalk		1		$\text{nV}\cdot\text{s}$	
DAC-to-DAC Crosstalk		3		$\text{nV}\cdot\text{s}$	
Multiplying Bandwidth		200		kHz	$V_{REF} = 2\text{ V} \pm 0.1\text{ V p-p}$
Total Harmonic Distortion		-70		dB	$V_{REF} = 2.5\text{ V} \pm 0.1\text{ V p-p}$. Frequency = 10 kHz

NOTES

¹Guaranteed by design and characterization, not production tested.

²See Terminology.

³Temperature range: B Version: -40°C to $+105^\circ\text{C}$; typical at 25°C .

Specifications subject to change without notice.

TIMING CHARACTERISTICS^{1, 2, 3} ($V_{DD} = 2.5\text{ V to }5.5\text{ V}$. All specifications T_{MIN} to T_{MAX} unless otherwise noted)

Parameter	Limit at T_{MIN} , T_{MAX}		Unit	Conditions/Comments
	$V_{DD} = 2.5\text{ V to }3.6\text{ V}$	$V_{DD} = 3.6\text{ V to }5.5\text{ V}$		
t_1	40	33	ns min	SCLK Cycle Time
t_2	16	13	ns min	SCLK High Time
t_3	16	13	ns min	SCLK Low Time
t_4	0	0	ns min	$\overline{\text{SYNC}}$ to SCLK Rising Edge Setup Time
t_5	5	5	ns min	Data Setup Time
t_6	4.5	4.5	ns min	Data Hold Time
t_7	0	0	ns min	SCLK Falling Edge to $\overline{\text{SYNC}}$ Rising Edge
t_8	80	33	ns min	Minimum $\overline{\text{SYNC}}$ High Time

NOTES

¹Guaranteed by design and characterization, not production tested.

²All input signals are specified with $t_r = t_f = 5\text{ ns}$ (10% to 90% of V_{DD}) and timed from a voltage level of $(V_{IL} + V_{IH})/2$.

³See Figure 1.

Specifications subject to change without notice.

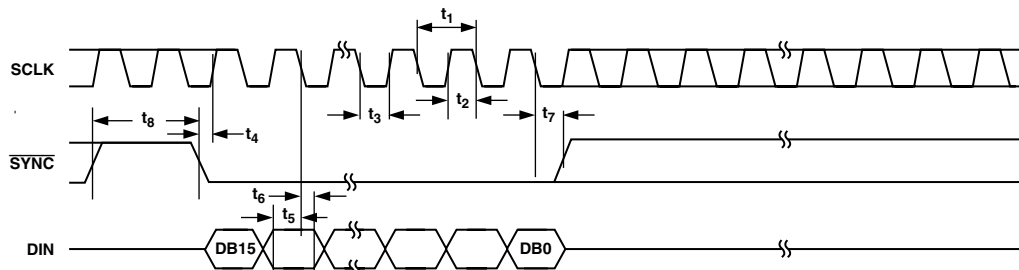

Figure 1. Serial Interface Timing Diagram

AD5304/AD5314/AD5324

ABSOLUTE MAXIMUM RATINGS^{1, 2}

(T_A = 25°C unless otherwise noted)

V _{DD} to GND	−0.3 V to +7 V
Digital Input Voltage to GND	−0.3 V to V _{DD} + 0.3 V
Reference Input Voltage to GND	−0.3 V to V _{DD} + 0.3 V
V _{OUTA–D} to GND	−0.3 V to V _{DD} + 0.3 V
Operating Temperature Range	
Industrial (B Version)	−40°C to +105°C
Storage Temperature Range	−65°C to +150°C
Junction Temperature (T _J max)	150°C
10-Lead microSOIC Package	
Power Dissipation	(T _J max − T _A)/θ _{JA}
θ _{JA} Thermal Impedance	206°C/W
θ _{JC} Thermal Impedance	44°C/W
Reflow Soldering	
Peak Temperature	220 +5/−0°C
Time at Peak Temperature	10 sec to 40 sec

NOTES

¹Stresses above those listed under Absolute Maximum Ratings may cause permanent damage to the device. This is a stress rating only; and functional operation of the device at these or any other conditions above those listed in the operational sections of this specification is not implied. Exposure to absolute maximum rating conditions for extended periods may affect device reliability.

²Transient currents of up to 100 mA will not cause SCR latch-up.

PIN CONFIGURATION

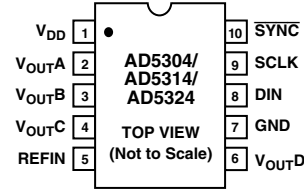

PIN FUNCTION DESCRIPTIONS

Pin No.	Mnemonic	Function
1	V _{DD}	Power Supply Input. These parts can be operated from 2.5 V to 5.5 V and the supply should be decoupled to GND.
2	V _{OUTA}	Buffered Analog Output Voltage from DAC A. The output amplifier has rail-to-rail operation.
3	V _{OUTB}	Buffered Analog Output Voltage from DAC B. The output amplifier has rail-to-rail operation.
4	V _{OUTC}	Buffered Analog Output Voltage from DAC C. The output amplifier has rail-to-rail operation.
5	REFIN	Reference Input Pin for All Four DACs. It has an input range from 0.25 V to V _{DD} .
6	V _{OUTD}	Buffered Analog Output Voltage from DAC D. The output amplifier has rail-to-rail operation.
7	GND	Ground Reference Point for All Circuitry on the Part.
8	DIN	Serial Data Input. This device has a 16-bit shift register. Data is clocked into the register on the falling edge of the serial clock input. The DIN input buffer is powered down after each write cycle.
9	SCLK	Serial Clock Input. Data is clocked into the input shift register on the falling edge of the serial clock input. Data can be transferred at clock speeds up to 30 MHz. The SCLK input buffer is powered down after each write cycle.
10	$\overline{\text{SYNC}}$	Active Low Control Input. This is the frame synchronization signal for the input data. When $\overline{\text{SYNC}}$ goes low, it enables the input shift register and data is transferred in on the falling edges of the following 16 clocks. If $\overline{\text{SYNC}}$ is taken high before the sixteenth falling edge of SCLK, the rising edge of $\overline{\text{SYNC}}$ acts as an interrupt and the write sequence is ignored by the device.

ORDERING GUIDE

Model	Temperature Range	Package Description	Package Option	Branding Information
AD5304BRM	−40°C to +105°C	10-Lead microSOIC	RM-10	DBB
AD5314BRM	−40°C to +105°C	10-Lead microSOIC	RM-10	DCB
AD5324BRM	−40°C to +105°C	10-Lead microSOIC	RM-10	DDB

CAUTION

ESD (electrostatic discharge) sensitive device. Electrostatic charges as high as 4000 V readily accumulate on the human body and test equipment and can discharge without detection. Although the AD5304/AD5314/AD5324 features proprietary ESD protection circuitry, permanent damage may occur on devices subjected to high-energy electrostatic discharges. Therefore, proper ESD precautions are recommended to avoid performance degradation or loss of functionality.



TERMINOLOGY**RELATIVE ACCURACY**

For the DAC, relative accuracy or integral nonlinearity (INL) is a measure of the maximum deviation, in LSBs, from a straight line passing through the endpoints of the DAC transfer function. Typical INL versus Code plots can be seen in Figures 4, 5, and 6.

DIFFERENTIAL NONLINEARITY

Differential Nonlinearity (DNL) is the difference between the measured change and the ideal 1 LSB change between any two adjacent codes. A specified differential nonlinearity of ± 1 LSB maximum ensures monotonicity. This DAC is guaranteed monotonic by design. Typical DNL versus Code plots can be seen in Figures 7, 8, and 9.

OFFSET ERROR

This is a measure of the offset error of the DAC and the output amplifier. It is expressed as a percentage of the full-scale range.

GAIN ERROR

This is a measure of the span error of the DAC. It is the deviation in slope of the actual DAC transfer characteristic from the ideal expressed as a percentage of the full-scale range.

OFFSET ERROR DRIFT

This is a measure of the change in offset error with changes in temperature. It is expressed in (ppm of full-scale range)/ $^{\circ}$ C.

GAIN ERROR DRIFT

This is a measure of the change in gain error with changes in temperature. It is expressed in (ppm of full-scale range)/ $^{\circ}$ C.

POWER-SUPPLY REJECTION RATIO (PSRR)

This indicates how the output of the DAC is affected by changes in the supply voltage. PSRR is the ratio of the change in V_{OUT} to a change in V_{DD} for full-scale output of the DAC. It is measured in dBs. V_{REF} is held at 2 V and V_{DD} is varied $\pm 10\%$.

DC CROSSTALK

This is the dc change in the output level of one DAC at midscale in response to a full-scale code change (all 0s to all 1s and vice versa) and output change of another DAC. It is expressed in μ V.

REFERENCE FEEDTHROUGH

This is the ratio of the amplitude of the signal at the DAC output to the reference input when the DAC output is not being updated. It is expressed in dBs.

MAJOR-CODE TRANSITION GLITCH ENERGY

Major-code transition glitch energy is the energy of the impulse injected into the analog output when the code in the DAC register changes state. It is normally specified as the area of the glitch in nV-secs and is measured when the digital code is changed by 1 LSB at the major carry transition (011 . . . 11 to 100 . . . 00 or 100 . . . 00 to 011 . . . 11).

DIGITAL FEEDTHROUGH

Digital feedthrough is a measure of the impulse injected into the analog output of the DAC from the digital input pins of the device when the DAC output is not being written to (SYNC held high). It is specified in nV-secs and is measured with a worst-case change on the digital input pins, e.g., from all 0s to all 1s or vice versa.

DIGITAL CROSSTALK

This is the glitch impulse transferred to the output of one DAC at midscale in response to a full-scale code change (all 0s to all 1s and vice versa) in the input register of another DAC. It is expressed in nV-secs.

DAC-TO-DAC CROSSTALK

This is the glitch impulse transferred to the output of one DAC due to a digital code change and subsequent output change of another DAC. This includes both digital and analog crosstalk. It is measured by loading one of the DACs with a full-scale code change (all 0s to all 1s and vice versa) with the \overline{LDAC} bit set low and monitoring the output of another DAC. The energy of the glitch is expressed in nV-secs.

MULTIPLYING BANDWIDTH

The amplifiers within the DAC have a finite bandwidth. The multiplying bandwidth is a measure of this. A sine wave on the reference (with full-scale code loaded to the DAC) appears on the output. The multiplying bandwidth is the frequency at which the output amplitude falls to 3 dB below the input.

TOTAL HARMONIC DISTORTION

This is the difference between an ideal sine wave and its attenuated version using the DAC. The sine wave is used as the reference for the DAC and the THD is a measure of the harmonics present on the DAC output. It is measured in dBs.

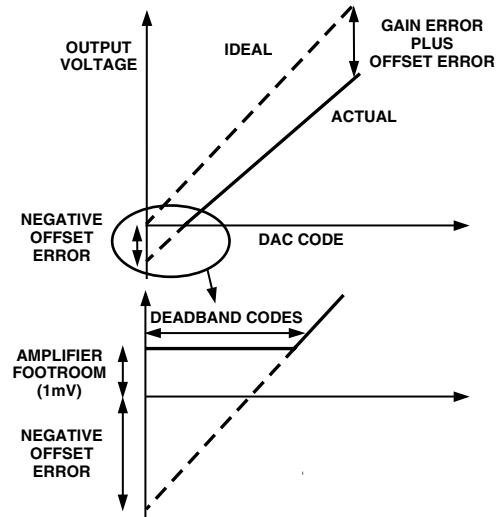

Figure 2. Transfer Function with Negative Offset

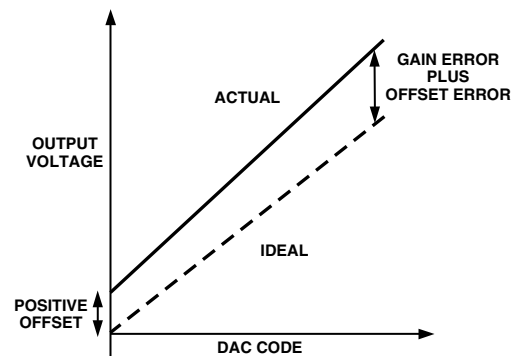

Figure 3. Transfer Function with Positive Offset

AD5304/AD5314/AD5324

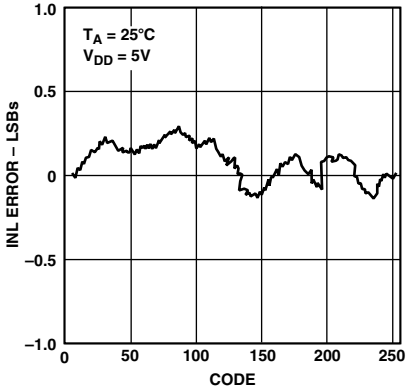

Figure 4. AD5304 Typical INL Plot

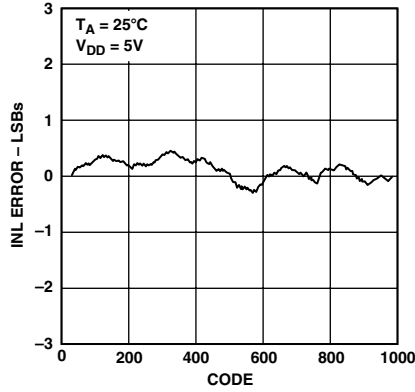

Figure 5. AD5314 Typical INL Plot

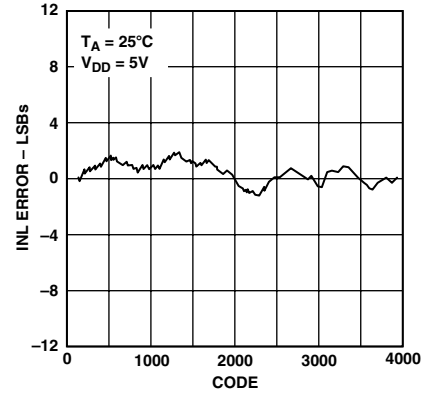

Figure 6. AD5324 Typical INL Plot

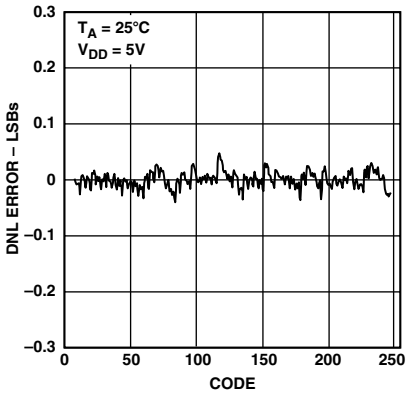

Figure 7. AD5304 Typical DNL Plot

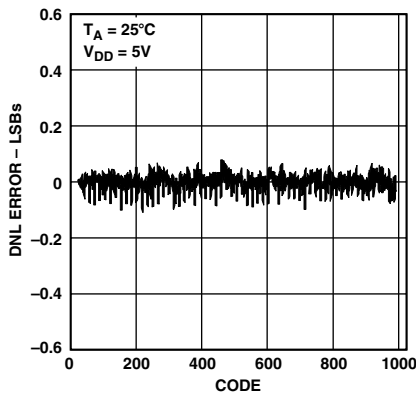

Figure 8. AD5314 Typical DNL Plot

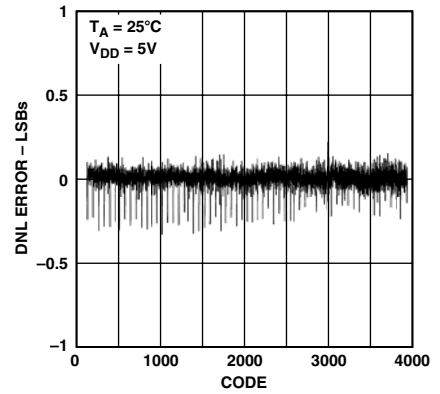

Figure 9. AD5324 Typical DNL Plot

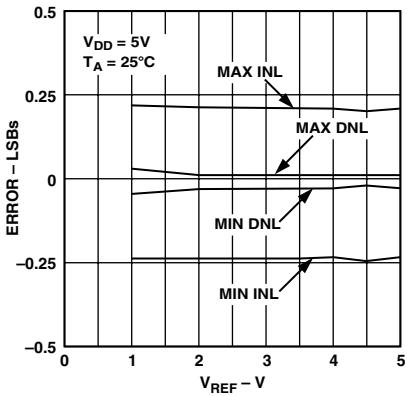

Figure 10. AD5304 INL and DNL Error vs. V_{REF}

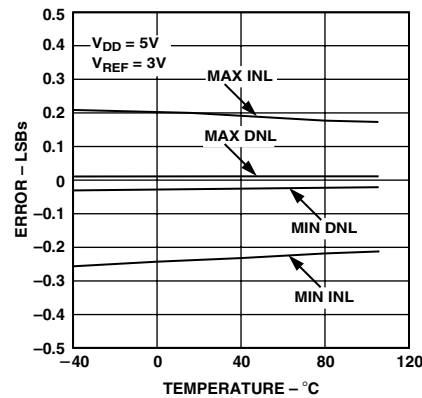

Figure 11. AD5304 INL Error and DNL Error vs. Temperature

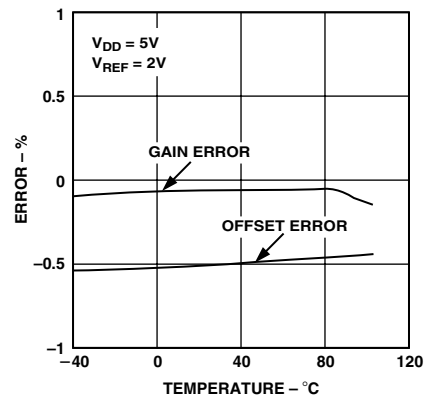

Figure 12. AD5304 Offset Error and Gain Error vs. Temperature

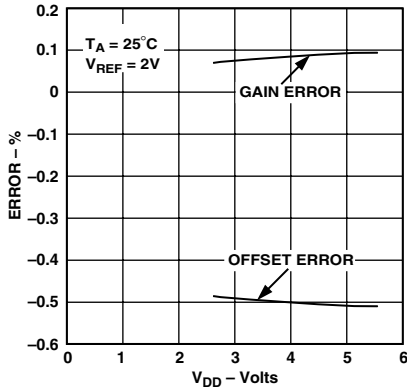

Figure 13. Offset Error and Gain Error vs. V_{DD}

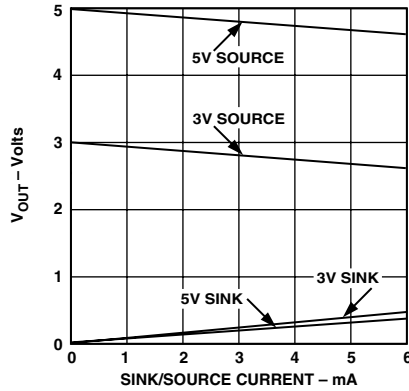

Figure 14. V_{OUT} Source and Sink Current Capability

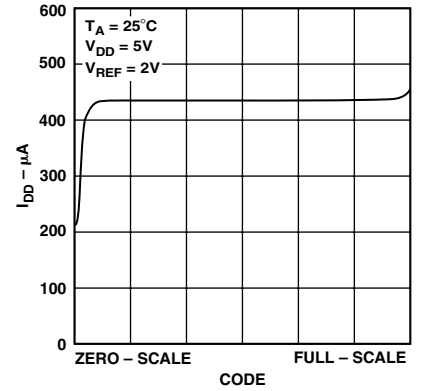

Figure 15. Supply Current vs. DAC Code

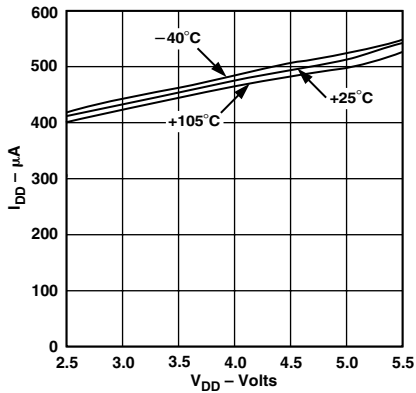

Figure 16. Supply Current vs. Supply Voltage

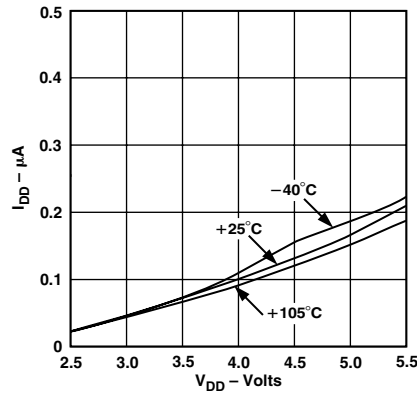

Figure 17. Power-Down Current vs. Supply Voltage

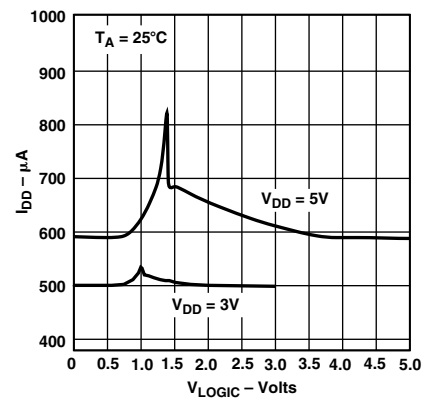

Figure 18. Supply Current vs. Logic Input Voltage

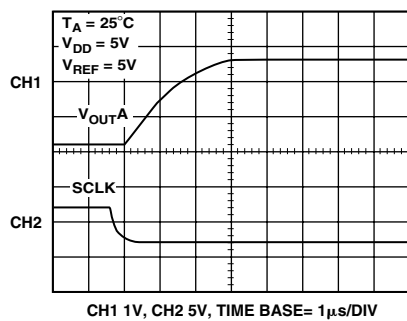

Figure 19. Half-Scale Settling (1/4 to 3/4 Scale Code Change)

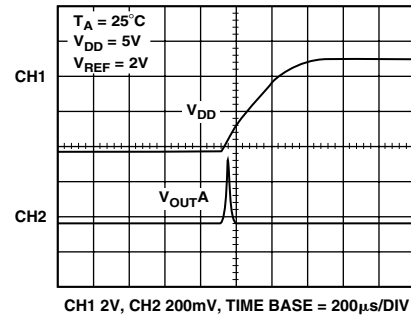

Figure 20. Power-On Reset to 0 V

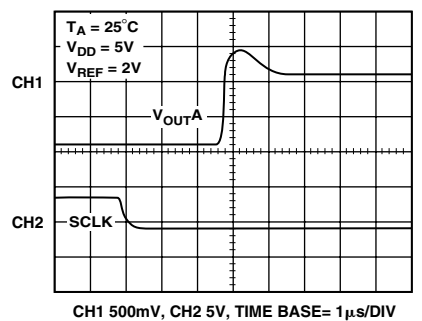

Figure 21. Exiting Power-Down to Midscale

AD5304/AD5314/AD5324

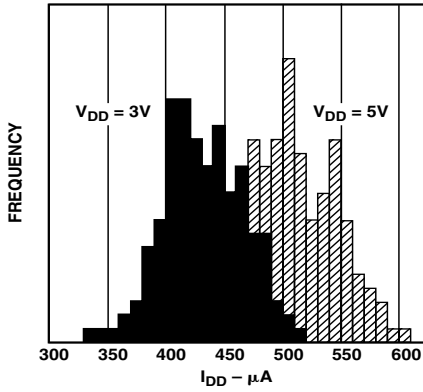

Figure 22. I_{DD} Histogram with $V_{DD} = 3\text{ V}$ and $V_{DD} = 5\text{ V}$

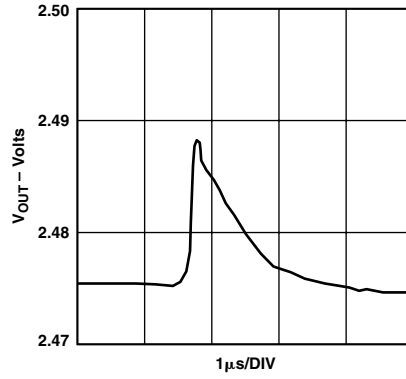

Figure 23. AD5324 Major-Code Transition Glitch Energy

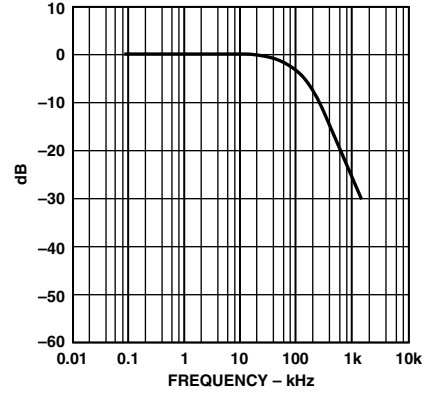

Figure 24. Multiplying Bandwidth (Small-Signal Frequency Response)

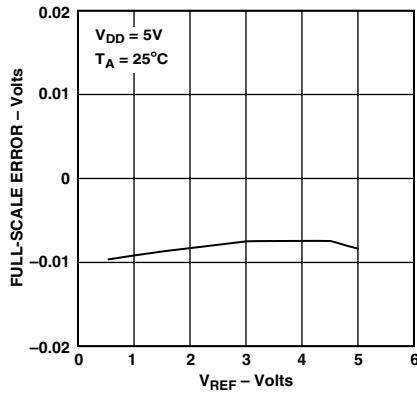

Figure 25. Full-Scale Error vs. V_{REF}

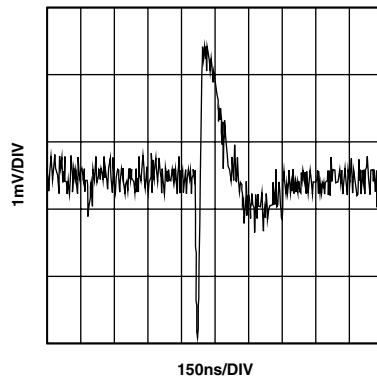

Figure 26. DAC-to-DAC Crosstalk

FUNCTIONAL DESCRIPTION

The AD5304/AD5314/AD5324 are quad resistor-string DACs fabricated on a CMOS process with resolutions of 8, 10, and 12 bits respectively. Each contains four output buffer amplifiers and is written to via a 3-wire serial interface. They operate from single supplies of 2.5 V to 5.5 V and the output buffer amplifiers provide rail-to-rail output swing with a slew rate of 0.7 V/μs. The four DACs share a single reference input pin. The devices have programmable power-down modes, in which all DACs may be turned off completely with a high-impedance output.

Digital-to-Analog Section

The architecture of one DAC channel consists of a resistor-string DAC followed by an output buffer amplifier. The voltage at the REFIN pin provides the reference voltage for the DAC. Figure 27 shows a block diagram of the DAC architecture. Since the input coding to the DAC is straight binary, the ideal output voltage is given by:

$$V_{OUT} = \frac{V_{REF} \times D}{2^N}$$

where

D = decimal equivalent of the binary code, which is loaded to the DAC register;

0–255 for AD5304 (8 Bits)

0–1023 for AD5314 (10 Bits)

0–4095 for AD5324 (12 Bits)

N = DAC resolution

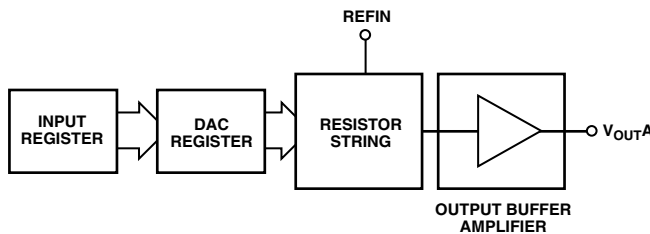

Figure 27. DAC Channel Architecture

Resistor String

The resistor string section is shown in Figure 28. It is simply a string of resistors, each of value R . The digital code loaded to the DAC register determines at which node on the string the voltage is tapped off to be fed into the output amplifier. The voltage is tapped off by closing one of the switches connecting the string to the amplifier. Because it is a string of resistors, it is guaranteed monotonic.

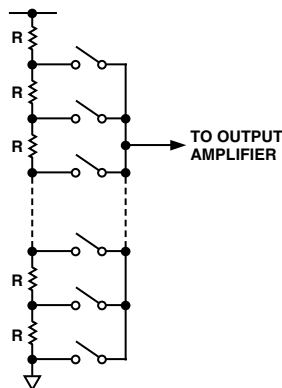

Figure 28. Resistor String

DAC Reference Inputs

There is a single reference input pin for the four DACs. The reference input is unbuffered. The user can have a reference voltage as low as 0.25 V and as high as V_{DD} since there is no restriction due to headroom and footroom of any reference amplifier.

It is recommended to use a buffered reference in the external circuit (e.g., REF192). The input impedance is typically 45 kΩ.

Output Amplifier

The output buffer amplifier is capable of generating rail-to-rail voltages on its output, which gives an output range of 0 V to V_{DD} when the reference is V_{DD} . It is capable of driving a load of 2 kΩ to GND or V_{DD} , in parallel with 500 pF to GND or V_{DD} . The source and sink capabilities of the output amplifier can be seen in the plot in Figure 14.

The slew rate is 0.7 V/μs with a half-scale settling time to ± 0.5 LSB (at 8 bits) of 6 μs.

POWER-ON RESET

The AD5304/AD5314/AD5324 are provided with a power-on reset function, so that they power up in a defined state. The power-on state is:

- Normal operation.
- Output voltage set to 0 V.

Both input and DAC registers are filled with zeros and remain so until a valid write sequence is made to the device. This is particularly useful in applications where it is important to know the state of the DAC outputs while the device is powering up.

SERIAL INTERFACE

The AD5304/AD5314/AD5324 are controlled over a versatile, 3-wire serial interface, which operates at clock rates up to 30 MHz and is compatible with SPI, QSPI, MICROWIRE, and DSP interface standards.

Input Shift Register

The input shift register is 16 bits wide. Data is loaded into the device as a 16-bit word under the control of a serial clock input, SCLK. The timing diagram for this operation is shown in Figure 1. The 16-bit word consists of four control bits followed by 8, 10, or 12 bits of DAC data, depending on the device type. Data is loaded MSB first (Bit 15) and the first two bits determine whether the data is for DAC A, DAC B, DAC C, or DAC D. Bits 13 and 12 control the operating mode of the DAC. Bit 13 is \overline{PD} , which determines whether the part is in normal or power-down mode. Bit 12 is \overline{LDAC} , which controls when DAC registers and outputs are updated.

Table I. Address Bits for the AD53x4

A1	A0	DAC Addressed
0	0	DAC A
0	1	DAC B
1	0	DAC C
1	1	DAC D

AD5304/AD5314/AD5324

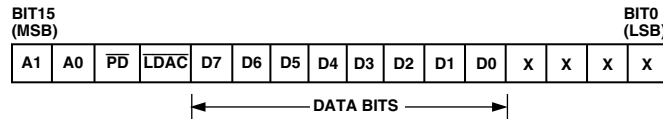

Figure 29. AD5304 Input Shift Register Contents

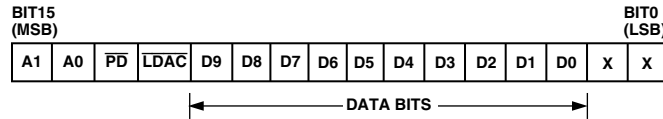

Figure 30. AD5314 Input Shift Register Contents

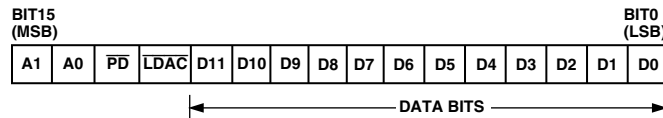

Figure 31. AD5324 Input Shift Register Contents

Address and Control Bits

PD: 0: All four DACs go into power-down mode consuming only 200 nA @ 5 V. The DAC outputs enter a high-impedance state.
1: Normal operation.

LDAC: 0: All four DAC registers and hence all DAC outputs updated simultaneously on completion of the write sequence.
1: Addressed input register only is updated. There is no change in the content of the DAC registers.

The AD5324 uses all 12 bits of DAC data, the AD5314 uses 10 bits and ignores the two LSBs. The AD5304 uses eight bits and ignores the last four bits. The data format is straight binary, with all zeros corresponding to 0 V output and all ones corresponding to full-scale output ($V_{REF} - 1$ LSB).

The $\overline{\text{SYNC}}$ input is a level-triggered input that acts as a frame synchronization signal and chip enable. Data can only be transferred into the device while $\overline{\text{SYNC}}$ is low. To start the serial data transfer, $\overline{\text{SYNC}}$ should be taken low, observing the minimum $\overline{\text{SYNC}}$ to SCLK active edge setup time, t_4 . After $\overline{\text{SYNC}}$ goes low, serial data will be shifted into the device's input shift register on the falling edges of SCLK for sixteen clock pulses. Any data and clock pulses after the sixteenth falling edge of SCLK will be ignored because the SCLK and DIN input buffers are powered down. No further serial data transfer will occur until $\overline{\text{SYNC}}$ is taken high and low again.

$\overline{\text{SYNC}}$ may be taken high after the falling edge of the sixteenth SCLK pulse, observing the minimum SCLK falling edge to $\overline{\text{SYNC}}$ rising edge time, t_7 .

After the end of serial data transfer, data will automatically be transferred from the input shift register to the input register of the selected DAC. If $\overline{\text{SYNC}}$ is taken high before the sixteenth falling edge of SCLK, the data transfer will be aborted and the DAC input registers will not be updated.

When data has been transferred into three of the DAC input registers, all DAC registers and all DAC outputs may simultaneously be updated by setting $\overline{\text{LDAC}}$ low when writing to the remaining DAC input register.

Low-Power Serial Interface

To reduce the power consumption of the device even further, the interface only powers up fully when the device is being written to, i.e., on the falling edge of $\overline{\text{SYNC}}$. As soon as the 16-bit control word has been written to the part, the SCLK and DIN input buffers are powered down. They only power up again following a falling edge of $\overline{\text{SYNC}}$.

Double-Buffered Interface

The AD5304/AD5314/AD5324 DACs all have double-buffered interfaces consisting of two banks of registers—input registers and DAC registers. The input register is directly connected to the input shift register and the digital code is transferred to the relevant input register on completion of a valid write sequence. The DAC register contains the digital code used by the resistor string.

Access to the DAC register is controlled by the $\overline{\text{LDAC}}$ bit. When the $\overline{\text{LDAC}}$ bit is set high, the DAC register is latched and hence the input register may change state without affecting the contents of the DAC register. However, when the $\overline{\text{LDAC}}$ bit is set low, all DAC registers are updated after a complete write sequence.

This is useful if the user requires simultaneous updating of all DAC outputs. The user may write to three of the input registers individually and then, by setting the $\overline{\text{LDAC}}$ bit low when writing to the remaining DAC input register, all outputs will update simultaneously.

These parts contain an extra feature whereby the DAC register is not updated unless its input register has been updated since the last time that $\overline{\text{LDAC}}$ was brought low. Normally, when $\overline{\text{LDAC}}$ is brought low, the DAC registers are filled with the contents of the input registers. In the case of the AD5304/AD5314/AD5324, the part will only update the DAC register if the input register has been changed since the last time the DAC register was updated, thereby removing unnecessary digital crosstalk.

POWER-DOWN MODE

The AD5304/AD5314/AD5324 have low power consumption, dissipating only 1.5 mW with a 3 V supply and 3 mW with a 5 V supply. Power consumption can be further reduced when the DACs are not in use by putting them into power-down mode, which is selected by a zero on Bit 13 ($\overline{\text{PD}}$) of the control word.

When the \overline{PD} bit is set to 1, all DACs work normally with a typical power consumption of 600 μA at 5 V (500 μA at 3 V). However, in power-down mode, the supply current falls to 200 nA at 5 V (80 nA at 3 V) when all DACs are powered down. Not only does the supply current drop, but the output stage is also internally switched from the output of the amplifier making it open-circuit. This has the advantage that the output is three-stated while the part is in power-down mode, and provides a defined input condition for whatever is connected to the output of the DAC amplifier. The output stage is illustrated in Figure 32.

The bias generator, the output amplifier, the resistor string, and all other associated linear circuitry are all shut down when the power-down mode is activated. However, the contents of the registers are unaffected when in power-down. The time to exit power-down is typically 2.5 μs for $V_{DD} = 5\text{ V}$ and 5 μs when $V_{DD} = 3\text{ V}$. This is the time from the falling edge of the sixteenth SCLK pulse to when the output voltage deviates from its power-down voltage. See Figure 21 for a plot.

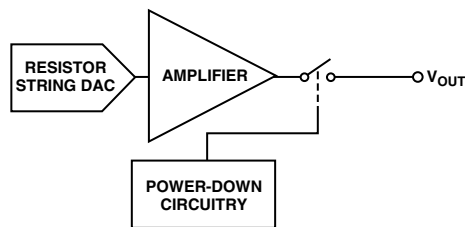

Figure 32. Output Stage During Power-Down

MICROPROCESSOR INTERFACING

AD5304/AD5314/AD5324 to ADSP-2101/ADSP-2103 Interface

Figure 33 shows a serial interface between the AD5304/AD5314/AD5324 and the ADSP-2101/ADSP-2103. The ADSP-2101/ADSP-2103 should be set up to operate in the SPORT Transmit Alternate Framing Mode. The ADSP-2101/ADSP-2103 SPORT is programmed through the SPORT control register and should be configured as follows: Internal Clock Operation, Active-Low Framing, 16-Bit Word Length. Transmission is initiated by writing a word to the Tx register after the SPORT has been enabled. The data is clocked out on each rising edge of the DSP's serial clock and clocked into the AD5304/AD5314/AD5324 on the falling edge of the DAC's SCLK.

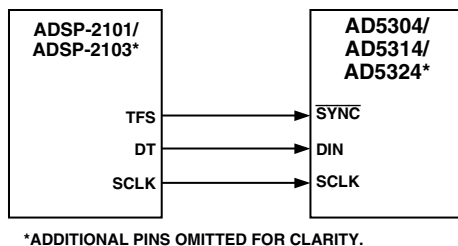
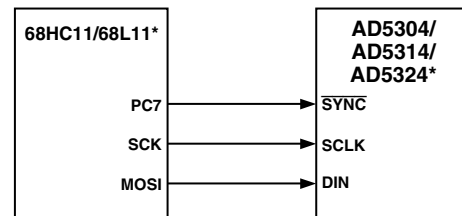

Figure 33. AD5304/AD5314/AD5324 to ADSP-2101/ADSP-2103 Interface

AD5304/AD5314/AD5324 to 68HC11/68L11 Interface

Figure 34 shows a serial interface between the AD5304/AD5314/AD5324 and the 68HC11/68L11 microcontroller. SCK of the 68HC11/68L11 drives the SCLK of the AD5304/AD5314/AD5324, while the MOSI output drives the serial data line (DIN) of the DAC. The \overline{SYNC} signal is derived from a port line (PC7). The setup conditions for correct operation of this interface are as follows: the 68HC11/68L11 should be configured so that its CPOL bit is a 0 and its CPHA bit is a 1. When data is being transmitted to the DAC, the \overline{SYNC} line is taken low (PC7). When the 68HC11/68L11 is configured as above, data appearing on the MOSI output is valid on the falling edge of SCK. Serial data from the 68HC11/68L11 is transmitted in 8-bit bytes with only eight falling clock edges occurring in the transmit cycle. Data is transmitted MSB first. In order to load data to the AD5304/AD5314/AD5324, PC7 is left low after the first eight bits are transferred, a second serial write operation is performed to the DAC, and PC7 is taken high at the end of this procedure.



*ADDITIONAL PINS OMITTED FOR CLARITY.

Figure 34. AD5304/AD5314/AD5324 to 68HC11/68L11 Interface

AD5304/AD5314/AD5324 to 80C51/80L51 Interface

Figure 35 shows a serial interface between the AD5304/AD5314/AD5324 and the 80C51/80L51 microcontroller. The setup for the interface is as follows: TxD of the 80C51/80L51 drives SCLK of the AD5304/AD5314/AD5324, while RxD drives the serial data line of the part. The \overline{SYNC} signal is again derived from a bit-programmable pin on the port. In this case port line P3.3 is used. When data is to be transmitted to the AD5304/AD5314/AD5324, P3.3 is taken low. The 80C51/80L51 transmits data only in 8-bit bytes; thus only eight falling clock edges occur in the transmit cycle. To load data to the DAC, P3.3 is left low after the first eight bits are transmitted, and a second write cycle is initiated to transmit the second byte of data. P3.3 is taken high following the completion of this cycle. The 80C51/80L51 outputs the serial data in a format which has the LSB first. The AD5304/AD5314/AD5324 requires its data with the MSB as the first bit received. The 80C51/80L51 transmit routine should take this into account.

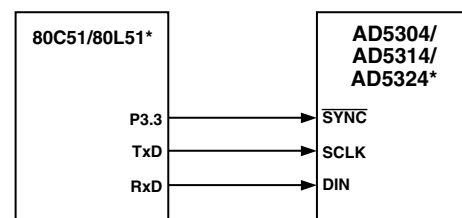

*ADDITIONAL PINS OMITTED FOR CLARITY.

Figure 35. AD5304/AD5314/AD5324 to 80C51/80L51 Interface

AD5304/AD5314/AD5324

AD5304/AD5314/AD5324 to MICROWIRE Interface

Figure 36 shows an interface between the AD5304/AD5314/AD5324 and any MICROWIRE-compatible device. Serial data is shifted out on the falling edge of the serial clock, SK and is clocked into the AD5304/AD5314/AD5324 on the rising edge of SK, which corresponds to the falling edge of the DAC's SCLK.

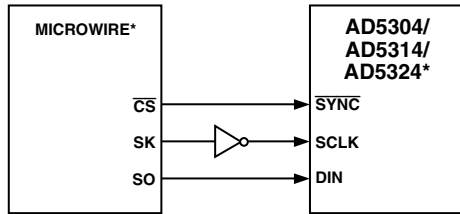

*ADDITIONAL PINS OMITTED FOR CLARITY.

Figure 36. AD5304/AD5314/AD5324 to MICROWIRE Interface

APPLICATIONS

Typical Application Circuit

The AD5304/AD5314/AD5324 can be used with a wide range of reference voltages where the devices offer full, one-quadrant multiplying capability over a reference range of 0 V to V_{DD} . More typically, these devices are used with a fixed, precision reference voltage. Suitable references for 5 V operation are the AD780 and REF192 (2.5 V references). For 2.5 V operation, a suitable external reference would be the AD589, a 1.23 V band-gap reference. Figure 37 shows a typical setup for the AD5304/AD5314/AD5324 when using an external reference.

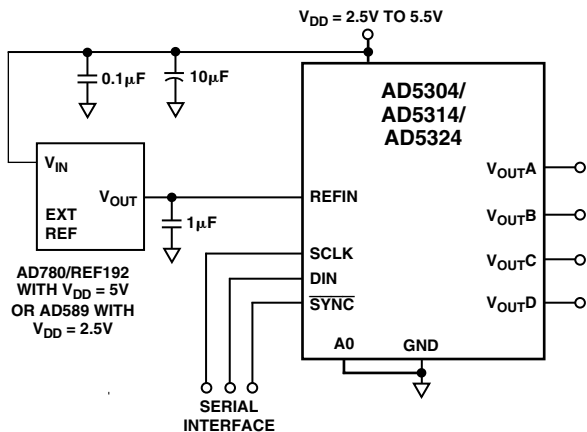

Figure 37. AD5304/AD5314/AD5324 Using External Reference

If an output range of 0 V to V_{DD} is required, the simplest solution is to connect the reference input to V_{DD} . As this supply may not be very accurate and may be noisy, the AD5304/AD5314/AD5324 may be powered from the reference voltage; for example, using a 5 V reference such as the REF195. The REF195 will output a steady supply voltage for the AD5304/AD5314/AD5324. The current required from the REF195 is 600 μ A supply current and approximately 112 μ A into the reference input. This is with no load on the DAC outputs. When the DAC outputs are loaded, the REF195 also needs to supply the current to the loads. The total current required (with a 10 k Ω load on each output) is:

$$712 \mu A + 4(5 V/10 k\Omega) = 2.70 mA$$

The load regulation of the REF195 is typically 2 ppm/mA, which results in an error of 5.4 ppm (27 μ V) for the 2.7 mA current drawn from it. This corresponds to a 0.0014 LSB error at 8 bits and 0.022 LSB error at 12 bits.

Bipolar Operation Using the AD5304/AD5314/AD5324

The AD5304/AD5314/AD5324 have been designed for single-supply operation, but a bipolar output range is also possible using the circuit in Figure 38. This circuit will give an output voltage range of ± 5 V. Rail-to-rail operation at the amplifier output is achievable using an AD820 or an OP295 as the output amplifier.

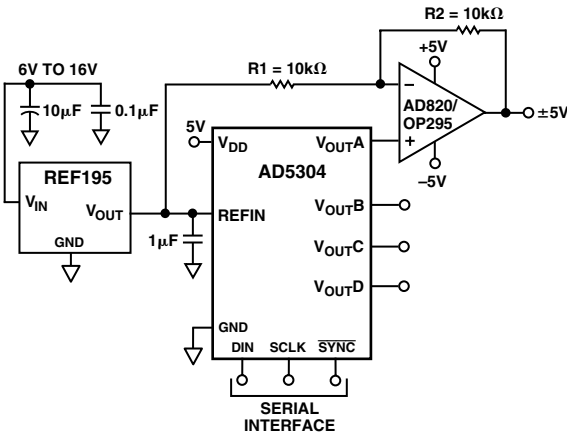

Figure 38. Bipolar Operation with the AD5304

The output voltage for any input code can be calculated as follows:

$$V_{OUT} = [(REFIN \times D/2^N) \times (R1+R2)/R1 - REFIN \times (R2/R1)]$$

where:

D is the decimal equivalent of the code loaded to the DAC.

N is the DAC resolution.

$REFIN$ is the reference voltage input.

with:

$REFIN = 5$ V, $R1 = R2 = 10$ k Ω :

$$V_{OUT} = (10 \times D/2^N) - 5$$

Opto-Isolated Interface for Process Control Applications

The AD5304/AD5314/AD5324 have a versatile 3-wire serial interface making them ideal for generating accurate voltages in process control and industrial applications. Due to noise, safety requirements or distance, it may be necessary to isolate the AD5304/AD5314/AD5324 from the controller. This can easily be achieved by using opto-isolators, which will provide isolation in excess of 3 kV. The actual data rate achieved may be limited by the type of optocouplers chosen. The serial loading structure of the AD5304/AD5314/AD5324 makes them ideally suited for use in opto-isolated applications. Figure 39 shows an opto-isolated interface to the AD5304 where DIN, SCLK, and SYNC are driven from optocouplers. The power supply to the part also needs to be isolated. This is done by using a transformer. On the DAC side of the transformer, a 5 V regulator provides the 5 V supply required for the AD5304.

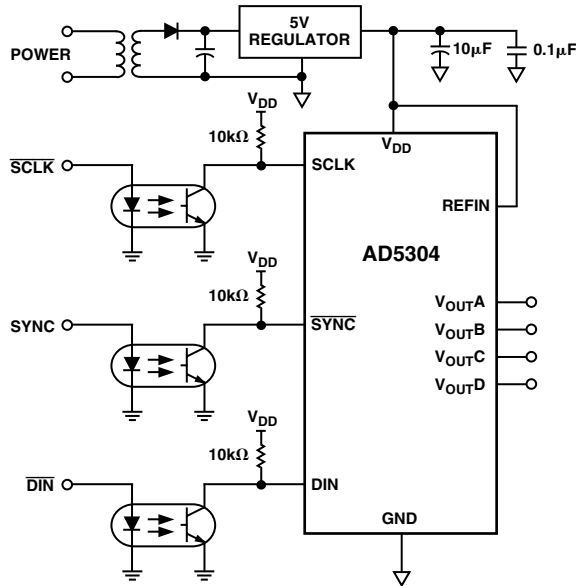

Figure 39. AD5304 in an Opto-Isolated Interface

Decoding Multiple AD5304/AD5314/AD5324s

The SYNC pin on the AD5304/AD5314/AD5324 can be used in applications to decode a number of DACs. In this application, all the DACs in the system receive the same serial clock and serial data, but the SYNC to only one of the devices will be active at any one time, allowing access to four channels in this 16-channel system. The 74HC139 is used as a 2-to-4-line decoder to address any of the DACs in the system. To prevent timing errors, the enable input should be brought to its inactive state while the coded address inputs are changing state. Figure 40 shows a diagram of a typical setup for decoding multiple AD5304 devices in a system.

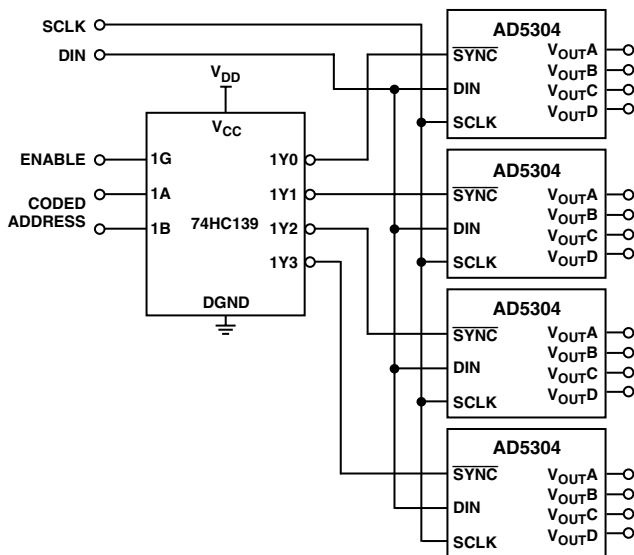
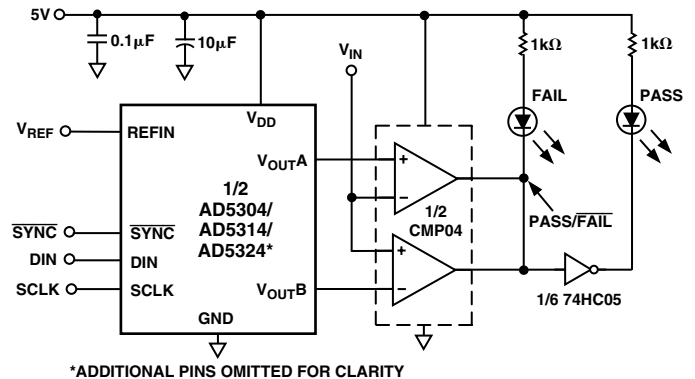

Figure 40. Decoding Multiple AD5304 Devices in a System

AD5304/AD5314/AD5324 as a Digitally Programmable Window Detector

A digitally programmable upper/lower limit detector using two of the DACs in the AD5304/AD5314/AD5324 is shown in Figure 41. The upper and lower limits for the test are loaded to DACs A and B which, in turn, set the limits on the CMP04. If the signal at the VIN input is not within the programmed window, an LED will indicate the fail condition. Similarly, DACs C and D can be used for window detection on a second VIN signal.



*ADDITIONAL PINS OMITTED FOR CLARITY

Figure 41. Window Detection

POWER SUPPLY BYPASSING AND GROUNDING

In any circuit where accuracy is important, careful consideration of the power supply and ground return layout helps to ensure the rated performance. The printed circuit board on which the AD5304/AD5314/AD5324 is mounted should be designed so that the analog and digital sections are separated, and confined to certain areas of the board. If the AD5304/AD5314/AD5324 is in a system where multiple devices require an AGND-to-DGND connection, the connection should be made at one point only. The star ground point should be established as close as possible to the device. The AD5304/AD5314/AD5324 should have ample supply bypassing of 10 µF in parallel with 0.1 µF on the supply located as close to the package as possible, ideally right up against the device. The 10 µF capacitors are the tantalum bead type. The 0.1 µF capacitor should have low Effective Series Resistance (ESR) and Effective Series Inductance (ESI), like the common ceramic types that provide a low impedance path to ground at high frequencies, to handle transient currents due to internal logic switching.

The power supply lines of the AD5304/AD5314/AD5324 should use as large a trace as possible to provide low impedance paths and reduce the effects of glitches on the power supply line. Fast switching signals such as clocks should be shielded with digital ground to avoid radiating noise to other parts of the board, and should never be run near the reference inputs. Avoid crossover of digital and analog signals. Traces on opposite sides of the board should run at right angles to each other. This reduces the effects of feedthrough through the board. A microstrip technique is by far the best, but not always possible with a double-sided board. In this technique, the component side of the board is dedicated to ground plane while signal traces are placed on the solder side.

AD5304/AD5314/AD5324

Table II. Overview of All AD53xx Serial Devices

Part No.	Resolution	No. of DACs	DNL	Interface	Settling Time	Package	Pins
SINGLES							
AD5300	8	1	±0.25	SPI	4 µs	SOT-23, microSOIC	6, 8
AD5310	10	1	±0.5	SPI	6 µs	SOT-23, microSOIC	6, 8
AD5320	12	1	±1.0	SPI	8 µs	SOT-23, microSOIC	6, 8
AD5301	8	1	±0.25	2-Wire	6 µs	SOT-23, microSOIC	6, 8
AD5311	10	1	±0.5	2-Wire	7 µs	SOT-23, microSOIC	6, 8
AD5321	12	1	±1.0	2-Wire	8 µs	SOT-23, microSOIC	6, 8
DUALS							
AD5302	8	2	±0.25	SPI	6 µs	microSOIC	8
AD5312	10	2	±0.5	SPI	7 µs	microSOIC	8
AD5322	12	2	±1.0	SPI	8 µs	microSOIC	8
AD5303	8	2	±0.25	SPI	6 µs	TSSOP	16
AD5313	10	2	±0.5	SPI	7 µs	TSSOP	16
AD5323	12	2	±1.0	SPI	8 µs	TSSOP	16
QUADS							
AD5304	8	4	±0.25	SPI	6 µs	microSOIC	10
AD5314	10	4	±0.5	SPI	7 µs	microSOIC	10
AD5324	12	4	±1.0	SPI	8 µs	microSOIC	10
AD5305	8	4	±0.25	2-Wire	6 µs	microSOIC	10
AD5315	10	4	±0.5	2-Wire	7 µs	microSOIC	10
AD5325	12	4	±1.0	2-Wire	8 µs	microSOIC	10
AD5306	8	4	±0.25	2-Wire	6 µs	TSSOP	16
AD5316	10	4	±0.5	2-Wire	7 µs	TSSOP	16
AD5326	12	4	±1.0	2-Wire	8 µs	TSSOP	16
AD5307	8	4	±0.25	SPI	6 µs	TSSOP	16
AD5317	10	4	±0.5	SPI	7 µs	TSSOP	16
AD5327	12	4	±1.0	SPI	8 µs	TSSOP	16

Visit our web-page at http://www.analog.com/support/standard_linear/selection_guides/AD53xx.html

OUTLINE DIMENSIONS

Dimensions shown in inches and (mm).

10-Lead microSOIC
(RM-10)

