

Altitude click™

1. Introduction

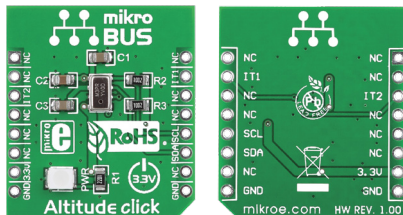

Altitude click™ is an accessory board in **mikroBUS™** form factor. It's a compact and easy solution for adding altimeter to your design. It features **MPL3115A2** precision pressure/temperature sensor which also provides altitude data. Altitude click™ communicates with the target board microcontroller via **mikroBUS™** I²C (SCL, SDA), INT and CS lines. The board is designed to use 3.3V power supply only. LED diode (GREEN) indicates the presence of power supply.

2. Soldering the headers

Before using your click™ board, make sure to solder 1x8 male headers to both left and right side of the board. Two 1x8 male headers are included with the board in the package.

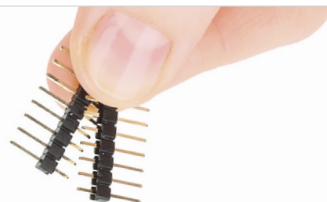

1

2

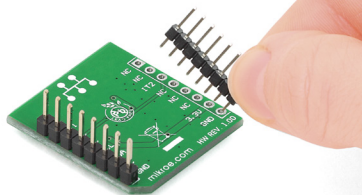

Turn the board upside down so that bottom side is facing you upwards. Place shorter pins of the header into the appropriate soldering pads.

3

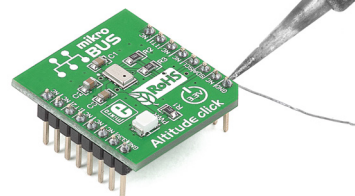

Turn the board upward again. Make sure to align the headers so that they are perpendicular to the board, then solder the pins carefully.

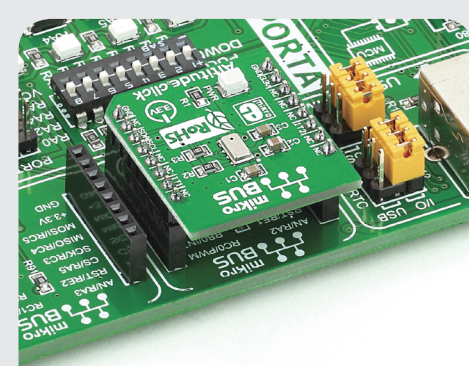

4. Essential features

Altitude click™ with its **MPL3115A2** IC employs a MEMS pressure sensor to provide accurate pressure/altitude (20-bit) and temperature (12-bit) data. Resolution is down to 30 cm (1.5 Pa). The **MPL3115A2** is capable of processing internal data automatically with data acquisition and compensation. This makes altitude sensor an ideal choice for smart phones/tablets, personal electronics altimetry, GPS systems, weather station equipment and many more.

3. Plugging the board in

Once you have soldered the headers your board is ready to be placed into desired mikroBUS™ socket. Make sure to align the cut in the lower-right part of the board with the markings on the silkscreen at the mikroBUS™ socket. If all of the pins are aligned correctly, push the board all the way into the socket.

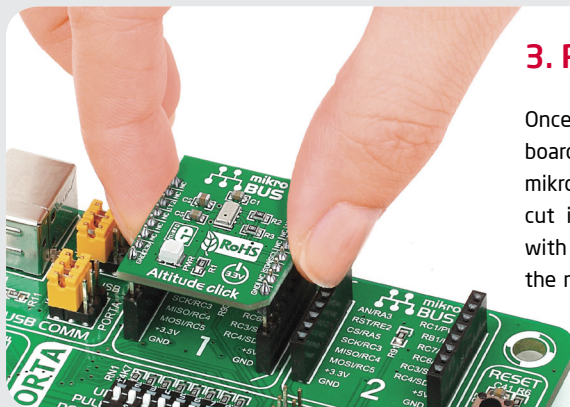

click™
BOARD
www.mikroe.com

Altitude click Manual
ver. 1.00



5. Altitude click™ Board Schematic

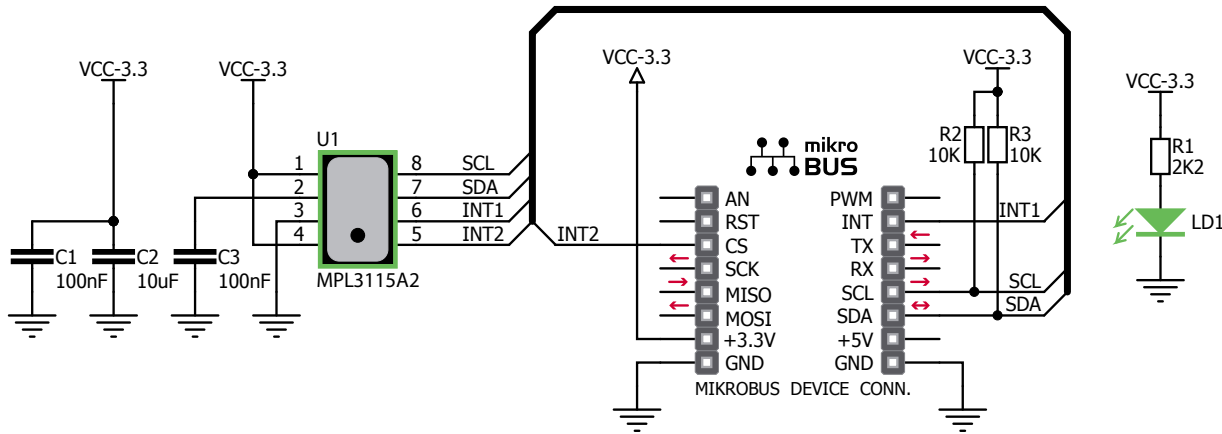

6. FIFO buffer

The **MPL3115A2** features 32 sample FIFO buffer to minimize the overhead of collecting multiple data samples. The FIFO stores both temperature and pressure/altitude data. The IC can be programmed to collect independently data at programmed intervals and store the data in the FIFO. It has ability to log data up to 12 days depending on data acquisition rate (1 second - 9 hour).

7. Code Examples

Once you have done all the necessary preparations, it's time to get your click™ board up and running. We have provided the examples for mikroC™, mikroBasic™ and mikroPascal™ compilers on our **Libstock** website. Just download them and you are ready to start.



8. Support

MikroElektronika offers **Free Tech Support** (www.mikroe.com/support) until the end of product lifetime, so if something goes wrong, we are ready and willing to help!