

## Small Signal Zener Diodes, Dual

### Features

- Dual silicon planar Zener diodes, common anode
- The Zener voltages are graded according to the international E 24 standard
- The parameters are valid for both diodes in one case.  $\Delta V_Z$  and  $\Delta R_{zj}$  of the two diodes in one case is  $\leq 5\%$
- Compliant to RoHS directive 2002/95/EC and in accordance to WEEE 2002/96/EC



**RoHS**  
COMPLIANT  
**GREEN**  
(5-2009)\*\*

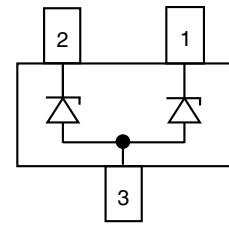
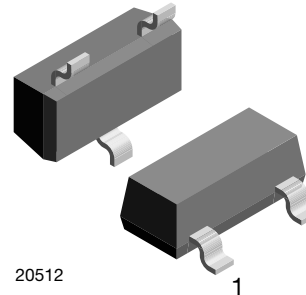

### Mechanical Data

**Case:** SOT-23

**Weight:** approx. 8.1 mg

**Packaging codes/options:**

GS18/10 k per 13" reel, (8 mm tape), 10 k/box

GS08/3 k per 7" reel, (8 mm tape), 15 k/box

### Absolute Maximum Ratings

$T_{amb} = 25\text{ }^\circ\text{C}$ , unless otherwise specified

Parameter	Test conditions	Symbol	Value	Unit
Power dissipation	Device on fiberglass substrate, see layout on page 6	$P_{tot}$	300	mW

### Thermal Characteristics

$T_{amb} = 25\text{ }^\circ\text{C}$ , unless otherwise specified

Parameter	Test conditions	Symbol	Value	Unit
Thermal resistance junction to ambient air	Device on fiberglass substrate, see layout on page 6	$R_{thJA}$	420	K/W
Junction temperature		$T_j$	150	$^\circ\text{C}$
Storage temperature range		$T_{stg}$	- 65 to + 150	$^\circ\text{C}$

\*\* Please see document "Vishay Material Category Policy": [www.vishay.com/doc?99902](http://www.vishay.com/doc?99902)

## Electrical Characteristics

Part number	Marking code	Zener voltage range <sup>1)</sup>		Dynamic resistance		Test current	Temperature coefficient of Zener voltage		Reverse voltage
		$V_Z$ at $I_{ZT}$		$R_{zj}$ at $I_{ZT} = 5 \text{ mA}$ , $f = 1 \text{ kHz}$	$R_{zj}$ at $I_{ZT} = 1 \text{ mA}$ , $f = 1 \text{ kHz}$	$I_{ZT}$	$\alpha_{VZ}$ at $I_{ZT}$		$V_R$ at $I_R = 100 \text{ nA}$
		V		$\Omega$		mA	$10^{-4}/^\circ\text{C}$		V
		min.	max.				min.	max.	
AZ23C2V7-V-G	D41	2.5	2.9	75 (< 83)	< 500	5	- 9	- 4	-
AZ23C3V0-V-G	D42	2.8	3.2	80 (< 95)	< 500	5	- 9	- 3	-
AZ23C3V3-V-G	D43	3.1	3.5	80 (< 95)	< 500	5	- 8	- 3	-
AZ23C3V6-V-G	D44	3.4	3.8	80 (< 95)	< 500	5	- 8	- 3	-
AZ23C3V9-V-G	D45	3.7	4.1	80 (< 95)	< 500	5	- 7	- 3	-
AZ23C4V3-V-G	D46	4	4.6	80 (< 95)	< 500	5	- 6	- 1	-
AZ23C4V7-V-G	D47	4.4	5	70 (< 78)	< 500	5	- 5	2	-
AZ23C5V1-V-G	D48	4.8	5.4	30 (< 60)	< 480	5	- 3	4	> 0.8
AZ23C5V6-V-G	D49	5.2	6	10 (< 40)	< 400	5	- 2	6	> 1
AZ23C6V2-V-G	D50	5.8	6.6	4.8 (< 10)	< 200	5	- 1	7	> 2
AZ23C6V8-V-G	D51	6.4	7.2	4.5 (< 8)	< 150	5	2	7	> 3
AZ23C7V5-V-G	D52	7	7.9	4 (< 7)	< 50	5	- 3	7	> 5
AZ23C8V2-V-G	D53	7.7	8.7	4.5 (< 7)	< 50	5	4	7	> 6
AZ23C9V1-V-G	D54	8.5	9.6	4.8 (< 10)	< 50	5	5	8	> 7
AZ23C10-V-G	D55	9.4	10.6	5.2 (< 15)	< 70	5	5	8	> 7.5
AZ23C11-V-G	D56	10.4	11.6	6 (< 20)	< 70	5	5	9	> 8.5
AZ23C12-V-G	D57	11.4	12.7	7 (< 20)	< 90	5	6	9	> 9
AZ23C13-V-G	D58	12.4	14.1	9 (< 25)	< 110	5	7	9	> 10
AZ23C15-V-G	D59	13.8	15.6	11 (< 30)	< 110	5	7	9	> 11
AZ23C16-V-G	D60	15.3	17.1	13 (< 40)	< 170	5	8	9.5	> 12
AZ23C18-V-G	D61	16.8	19.1	18 (< 50)	< 170	5	8	9.5	> 14
AZ23C20-V-G	D62	18.8	21.2	20 (< 50)	< 220	5	8	10	> 15
AZ23C22-V-G	D63	20.8	23.3	25 (< 55)	< 220	5	8	10	> 17
AZ23C24-V-G	D64	22.8	25.6	28 (< 80)	< 220	5	8	10	> 18
AZ23C27-V-G	D65	25.1	28.9	30 (< 80)	< 250	5	8	10	> 20
AZ23C30-V-G	D66	28	32	35 (< 80)	< 250	5	8	10	> 22.5
AZ23C33-V-G	D67	31	35	40 (< 80)	< 250	5	8	10	> 25
AZ23C36-V-G	D68	34	38	40 (< 90)	< 250	5	8	10	> 27
AZ23C39-V-G	D69	37	41	50 (< 90)	< 300	5	10	12	> 29
AZ23C43-V-G	D70	40	46	60 (< 100)	< 700	5	10	12	> 32
AZ23C47-V-G	D71	44	50	70 (< 100)	< 750	5	10	12	> 35
AZ23C51-V-G	D72	48	54	70 (< 100)	< 750	5	10	12	> 38

**Note**

<sup>1)</sup> Tested with pulses  $t_p = 5 \text{ ms}$

## Electrical Characteristics

Part number	Marking code	Zener voltage range <sup>1)</sup>		Dynamic resistance		Test current	Temperature coefficient of Zener voltage		Reverse voltage
		$V_Z$ at $I_{ZT}$		$R_{zj}$ at $I_{ZT} = 5 \text{ mA}$ , $f = 1 \text{ kHz}$	$R_{zj}$ at $I_{ZT} = 1 \text{ mA}$ , $f = 1 \text{ kHz}$	$I_{ZT}$	$\alpha_{VZ}$ at $I_{ZT}$		$V_R$ at $I_R = 100 \text{ nA}$
		V		$\Omega$		mA	$10^{-4}/^\circ\text{C}$		V
		min.	max.				min.	max.	
AZ23B2V7-V-G	D41	2.65	2.75	75 (< 83)	< 500	5	- 9	- 4	-
AZ23B3V0-V-G	D42	2.94	3.06	80 (< 95)	< 500	5	- 9	- 3	-
AZ23B3V3-V-G	D43	3.23	3.37	80 (< 95)	< 500	5	- 8	- 3	-
AZ23B3V6-V-G	D44	3.53	3.67	80 (< 95)	< 500	5	- 8	- 3	-
AZ23B3V9-V-G	D45	3.82	3.98	80 (< 95)	< 500	5	- 7	- 3	-
AZ23B4V3-V-G	D46	4.21	4.39	80 (< 95)	< 500	5	- 6	- 1	-
AZ23B4V7-V-G	D47	4.61	4.79	70 (< 78)	< 500	5	- 5	2	-
AZ23B5V1-V-G	D48	5	5.2	30 (< 60)	< 480	5	- 3	4	> 0.8
AZ23B5V6-V-G	D49	5.49	5.71	10 (< 40)	< 400	5	- 2	6	> 1
AZ23B6V2-V-G	D50	6.08	6.32	4.8 (< 10)	< 200	5	- 1	7	> 2
AZ23B6V8-V-G	D51	6.66	6.94	4.5 (< 8)	< 150	5	2	7	> 3
AZ23B7V5-V-G	D52	7.35	7.65	4 (< 7)	< 50	5	- 3	7	> 5
AZ23B8V2-V-G	D53	8.04	8.36	4.5 (< 7)	< 50	5	4	7	> 6
AZ23B9V1-V-G	D54	8.92	9.28	4.8 (< 10)	< 50	5	5	8	> 7
AZ23B10-V-G	D55	9.8	10.2	5.2 (< 15)	< 70	5	5	8	> 7.5
AZ23B11-V-G	D56	10.8	11.2	6 (< 20)	< 70	5	5	9	> 8.5
AZ23B12-V-G	D57	11.8	12.2	7 (< 20)	< 90	5	6	9	> 9
AZ23B13-V-G	D58	12.7	13.3	9 (< 25)	< 110	5	7	9	> 10
AZ23B15-V-G	D59	14.7	15.3	11 (< 30)	< 110	5	7	9	> 11
AZ23B16-V-G	D60	15.7	16.3	13 (< 40)	< 170	5	8	0.5	> 12
AZ23B18-V-G	D61	17.6	18.4	18 (< 50)	< 170	5	8	0.5	> 14
AZ23B20-V-G	D62	19.6	20.4	20 (< 50)	< 220	5	8	10	> 15
AZ23B22-V-G	D63	21.6	22.4	25 (< 55)	< 220	5	8	10	> 17
AZ23B24-V-G	D64	23.5	24.5	28 (< 80)	< 220	5	8	10	> 18
AZ23B27-V-G	D65	26.5	27.5	30 (< 80)	< 250	5	8	10	> 20
AZ23B30-V-G	D66	29.4	30.6	35 (< 80)	< 250	5	8	10	> 22.5
AZ23B33-V-G	D67	32.3	33.7	40 (< 80)	< 250	5	8	10	> 25
AZ23B36-V-G	D68	35.3	36.7	40 (< 90)	< 250	5	8	10	> 27
AZ23B39-V-G	D69	38.2	39.8	50 (< 90)	< 300	5	10	12	> 29
AZ23B43-V-G	D70	42.1	43.9	60 (< 100)	< 700	5	10	12	> 32
AZ23B47-V-G	D71	46.1	47.9	70 (< 100)	< 750	5	10	12	> 35
AZ23B51-V-G	D72	50	52	70 (< 100)	< 750	5	10	12	> 38

**Note**

<sup>1)</sup> Tested with pulses  $t_p = 5 \text{ ms}$

### Typical Characteristics

$T_{amb} = 25\text{ }^{\circ}\text{C}$ , unless otherwise specified

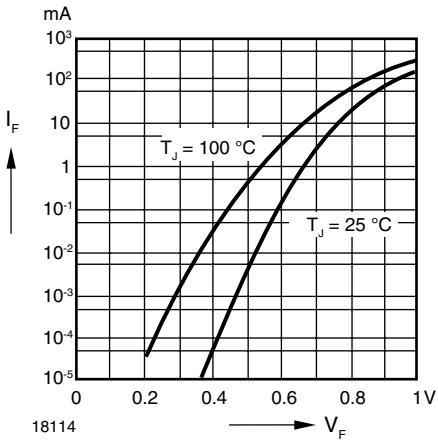

Figure 1. Forward characteristics

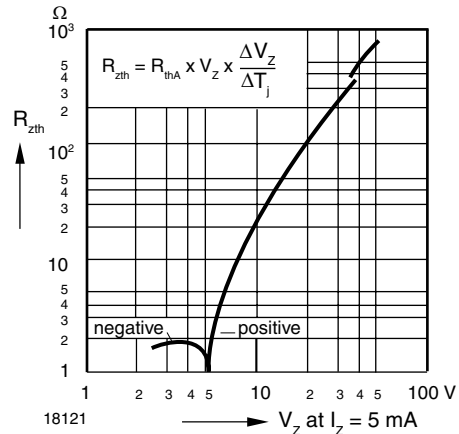

Figure 4. Thermal Differential Resistance vs. Zener Voltage

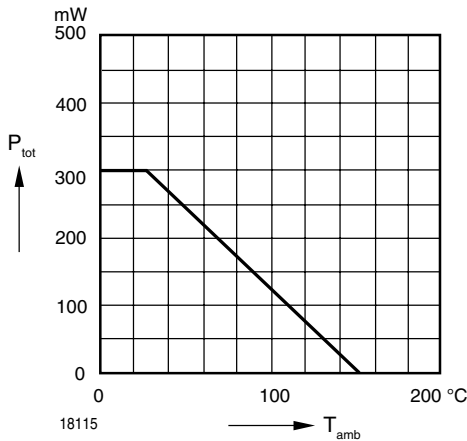

Figure 2. Admissible Power Dissipation vs. Ambient Temperature

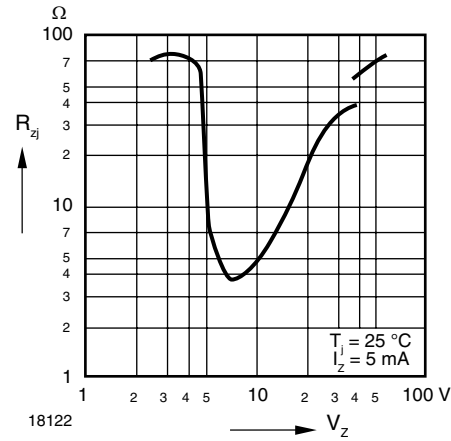

Figure 5. Dynamic Resistance vs. Zener Voltage

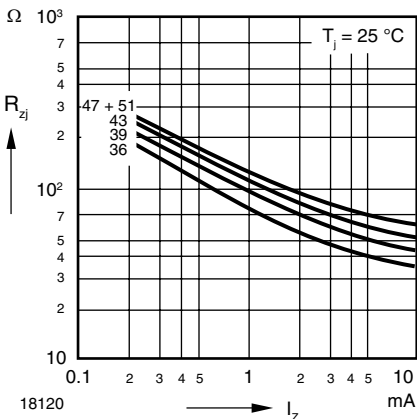

Figure 3. Dynamic Resistance vs. Zener Current

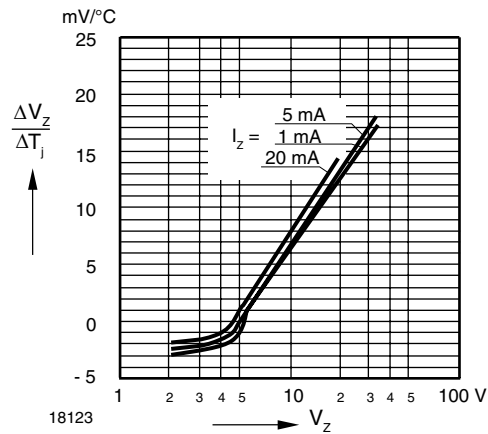

Figure 6. Temperature Dependence of Zener Voltage vs. Zener Voltage

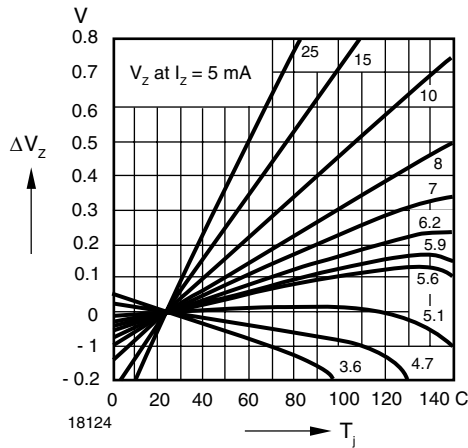

Figure 7. Change of Zener Voltage vs. Junction Temperature

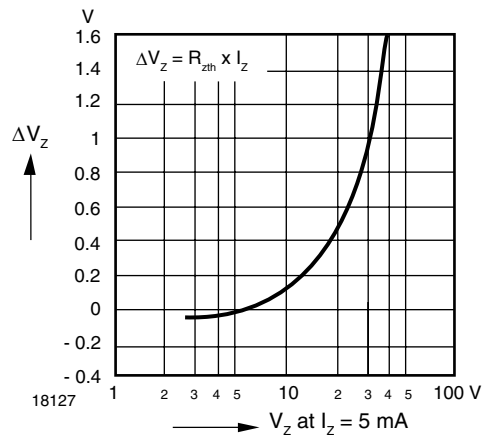

Figure 10. Change of Zener Voltage from Turn-on up to the Point of Thermal Equilibrium vs. Zener Voltage

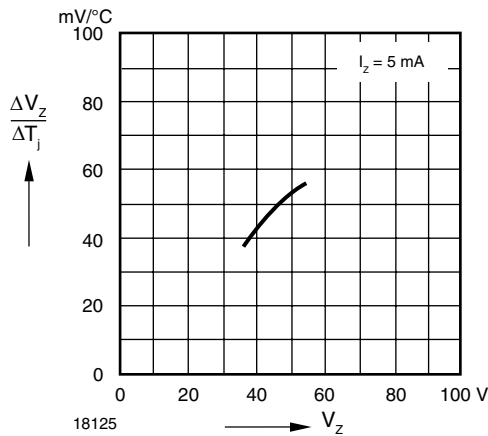

Figure 8. Temperature Dependence of Zener Voltage vs. Zener Voltage

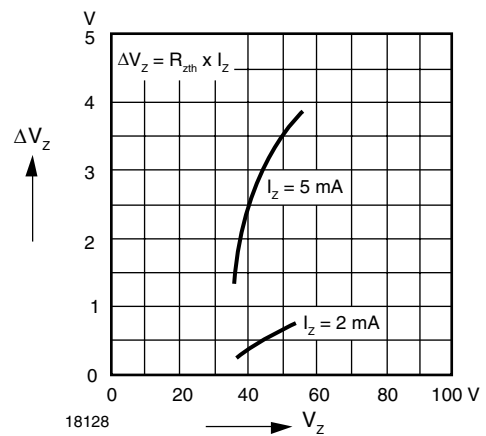

Figure 11. Change of Zener Voltage from Turn-on up to the Point of Thermal Equilibrium vs. Zener Voltage

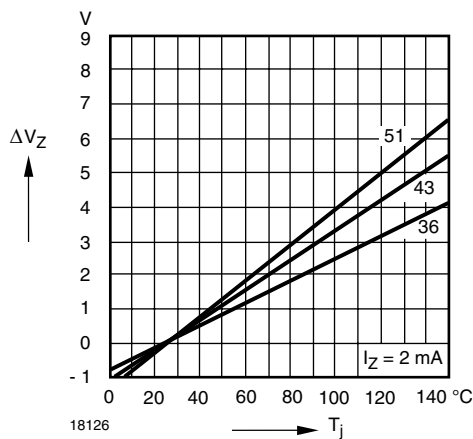

Figure 9. Change of Zener Voltage vs. Junction Temperature

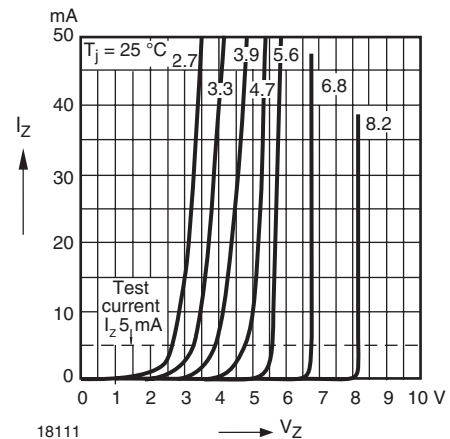

Figure 12. Breakdown Characteristics

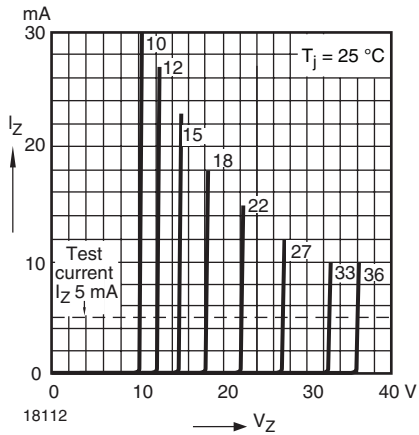

Figure 13. Breakdown Characteristics

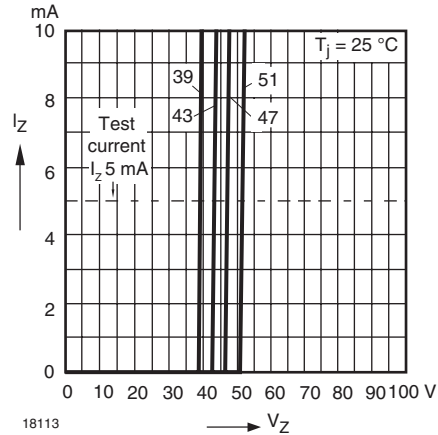
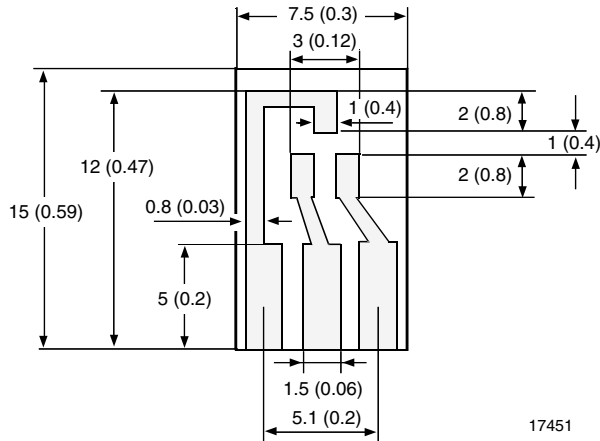

Figure 14. Breakdown Characteristics

## Layout for $R_{thJA}$ test

Thickness: Fiberglass 0.059 inches (1.5 mm)

Copper leads 0.012 inches (0.3 mm)



## Package Dimensions in millimeters (inches): SOT-23

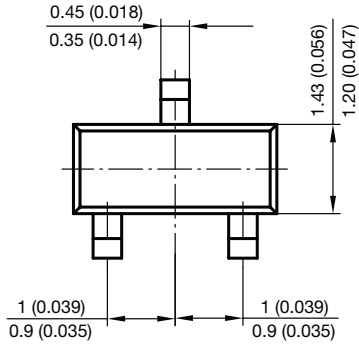
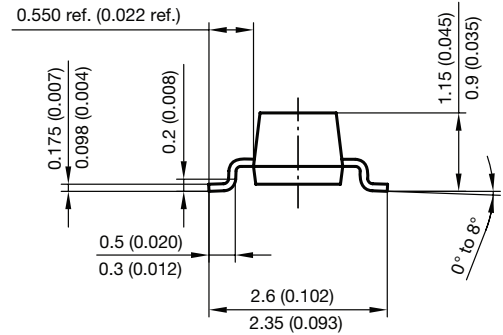
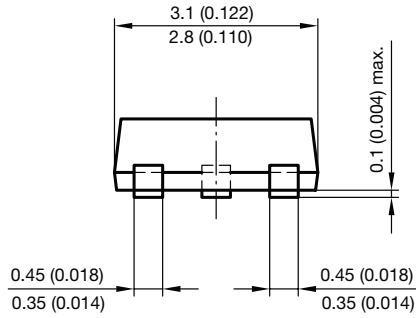

Foot print recommendation:

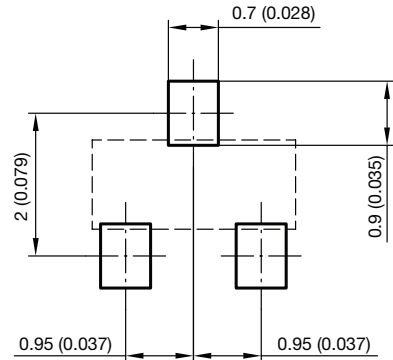

Document no.: 6.541-5014.01-4

Rev. 8 - Date: 23.Sept.2009

17418



## Disclaimer

All product specifications and data are subject to change without notice.

Vishay Intertechnology, Inc., its affiliates, agents, and employees, and all persons acting on its or their behalf (collectively, "Vishay"), disclaim any and all liability for any errors, inaccuracies or incompleteness contained herein or in any other disclosure relating to any product.

Vishay disclaims any and all liability arising out of the use or application of any product described herein or of any information provided herein to the maximum extent permitted by law. The product specifications do not expand or otherwise modify Vishay's terms and conditions of purchase, including but not limited to the warranty expressed therein, which apply to these products.

No license, express or implied, by estoppel or otherwise, to any intellectual property rights is granted by this document or by any conduct of Vishay.

The products shown herein are not designed for use in medical, life-saving, or life-sustaining applications unless otherwise expressly indicated. Customers using or selling Vishay products not expressly indicated for use in such applications do so entirely at their own risk and agree to fully indemnify Vishay for any damages arising or resulting from such use or sale. Please contact authorized Vishay personnel to obtain written terms and conditions regarding products designed for such applications.

Product names and markings noted herein may be trademarks of their respective owners.