

BAS16VV; BAS16VY

Triple high-speed switching diodes

Rev. 02 — 10 September 2004

Product data sheet

1. Product profile

1.1 General description

Three electrically isolated high-speed switching diodes, encapsulated in very small SMD plastic packages.

Table 1: Product overview

Type number	Package		Configuration
	Philips	EIAJ	
BAS16VV	SOT666	-	triple isolated diode
BAS16VY	SOT363	SC-88	triple isolated diode

1.2 Features

- Very small SMD plastic packages
- High-speed switching
- Three electrically isolated diodes
- Low capacitance.

1.3 Applications

- General purpose switching in surface mounted circuits.

1.4 Quick reference data

Table 2: Quick reference data

Symbol	Parameter	Conditions	Min	Typ	Max	Unit
V_R	reverse voltage		-	-	100	V
I_{FRM}	repetitive peak forward current		-	-	450	mA
t_{rr}	reverse recovery time		-	-	4	ns

PHILIPS

2. Pinning information

Table 3: Discrete pinning

Pin	Description	Simplified outline	Symbol
1	anode (diode 1)	<p>001aab555</p>	<p>sym043</p>
2	anode (diode 2)		
3	anode (diode 3)		
4	cathode (diode 3)		
5	cathode (diode 2)		
6	cathode (diode 1)		

3. Ordering information

Table 4: Ordering information

Type number	Package		
	Name	Description	Version
BAS16VV	-	plastic surface mounted package; 6 leads	SOT666
BAS16VY	SC-88	plastic surface mounted package; 6 leads	SOT363

4. Marking

Table 5: Marking

Type number	Marking code ^[1]
BAS16VV	53
BAS16VY	16*

- [1] * = p: Made in Hong Kong
 * = t: Made in Malaysia
 * = W: Made in China

5. Limiting values

Table 6: Limiting values

In accordance with the Absolute Maximum Rating System (IEC 60134).

Symbol	Parameter	Conditions	Min	Max	Unit
Per diode					
V_{RRM}	repetitive peak reverse voltage		-	100	V
V_R	reverse voltage		-	100	V
I_F	forward current		-	200	mA
I_{FRM}	repetitive peak forward current		-	450	mA

Table 6: Limiting values ...continued
In accordance with the Absolute Maximum Rating System (IEC 60134).

Symbol	Parameter	Conditions	Min	Max	Unit	
I_{FSM}	non-repetitive peak forward current	square wave	[1] -			
		$t_p = 1 \mu s$	-	4.5	A	
		$t_p = 1 ms$	-	1	A	
		$t_p = 1 s$	-	0.5	A	
P_{tot}	total power dissipation					
		SOT666	$T_{amb} \leq 25 \text{ }^\circ\text{C}$	[2] [3] -	180	mW
		SOT363	$T_{sp} = 85 \text{ }^\circ\text{C}$	[4] -	250	mW
T_j	junction temperature		-	150	$^\circ\text{C}$	
T_{amb}	ambient temperature		-65	+150	$^\circ\text{C}$	
T_{stg}	storage temperature		-65	+150	$^\circ\text{C}$	

- [1] $T_j = 25 \text{ }^\circ\text{C}$ prior to surge; see [Figure 2](#).
- [2] Device mounted on a FR4 printed-circuit board, single-sided copper, tin-plated and standard footprint.
- [3] Single diode loaded.
- [4] Solder points at pins 2, 3, 5 and 6.

6. Thermal characteristics

Table 7: Thermal characteristics

Symbol	Parameter	Conditions	Min	Typ	Max	Unit
$R_{th(j-a)}$	thermal resistance from junction to ambient	in free air				
		SOT666	[1] [2] -	-	700	K/W
			[2] [3] -	-	410	K/W
$R_{th(j-s)}$	thermal resistance from junction to soldering point					
		SOT363	[4] -	-	260	K/W

- [1] Refer to SOT666 standard mounting conditions.
- [2] Reflow soldering is the only recommended soldering method.
- [3] Device mounted on a FR4 printed-circuit board, single-sided copper, tin-plated, 1 cm² collector mounting pad.
- [4] Solder points at pins 2, 3, 5 and 6.

7. Characteristics

Table 8: Characteristics

$T_{amb} = 25\text{ °C}$ unless otherwise specified.

Symbol	Parameter	Conditions	Min	Typ	Max	Unit
Per diode						
V_F	forward voltage	see Figure 1				
		$I_F = 1\text{ mA}$	-	-	715	mV
		$I_F = 10\text{ mA}$	-	-	855	mV
		$I_F = 50\text{ mA}$	-	-	1	V
I_R	reverse current	see Figure 3				
		$V_R = 25\text{ V}$	-	-	30	nA
		$V_R = 75\text{ V}$	-	-	1	μA
		$V_R = 25\text{ V}; T_j = 150\text{ °C}$	-	-	30	μA
C_d	diode capacitance	$V_R = 0\text{ V}; f = 1\text{ MHz};$ see Figure 4	-	-	1.5	pF
t_{rr}	reverse recovery time	see Figure 5	[1]	-	4	ns
V_{fr}	forward recovery voltage	see Figure 6	[2]	-	1.75	V

[1] When switched from $I_F = 10\text{ mA}$ to $I_R = 10\text{ mA}$; $R_L = 100\ \Omega$; measured at $I_R = 1\text{ mA}$.

[2] When switched from $I_F = 10\text{ mA}$; $t_r = 20\text{ ns}$.

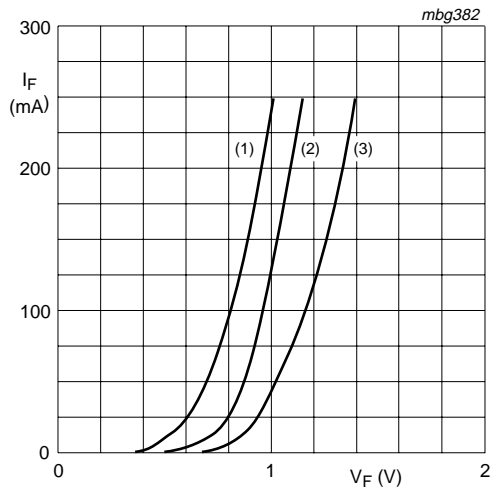

- (1) $T_j = 150\text{ }^\circ\text{C}$; typical values.
- (2) $T_j = 25\text{ }^\circ\text{C}$; typical values.
- (3) $T_j = 25\text{ }^\circ\text{C}$; maximum values.

Fig 1. Forward current as a function of forward voltage.

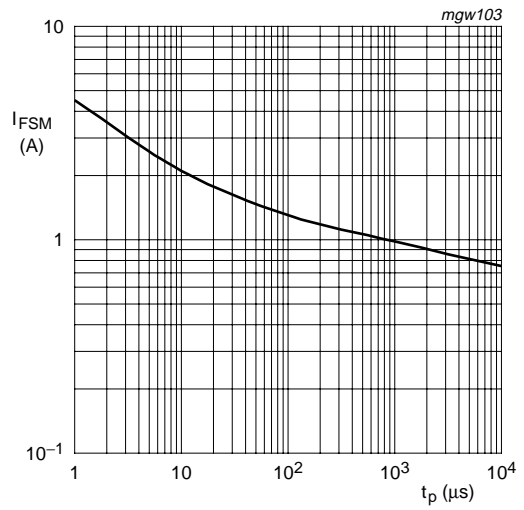

Based on square wave currents.
 $T_j = 25\text{ }^\circ\text{C}$ prior to surge.

Fig 2. Maximum permissible non-repetitive peak forward current as a function of pulse duration.

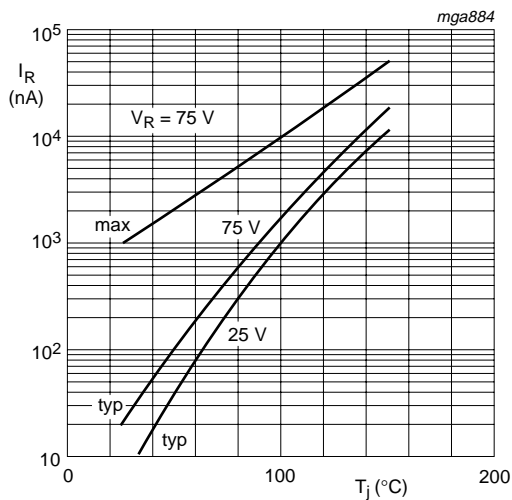
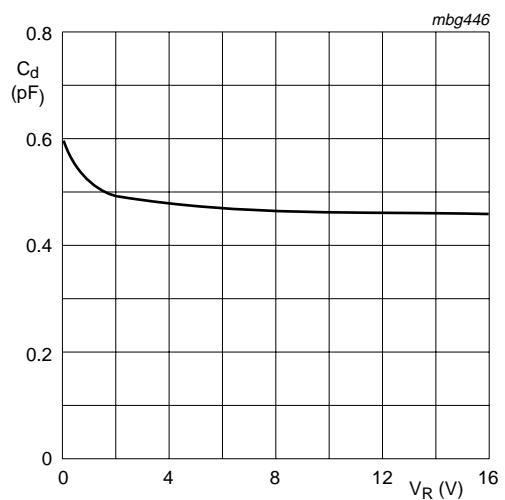

Fig 3. Reverse current as a function of junction temperature.



$f = 1\text{ MHz}$; $T_j = 25\text{ }^\circ\text{C}$.

Fig 4. Diode capacitance as a function of reverse voltage; typical values.

8. Test information

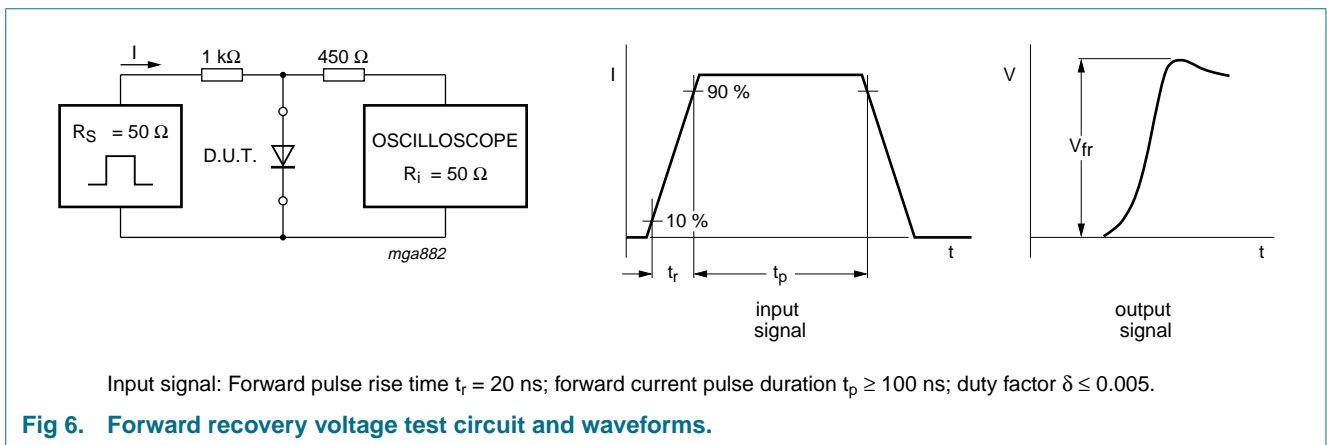
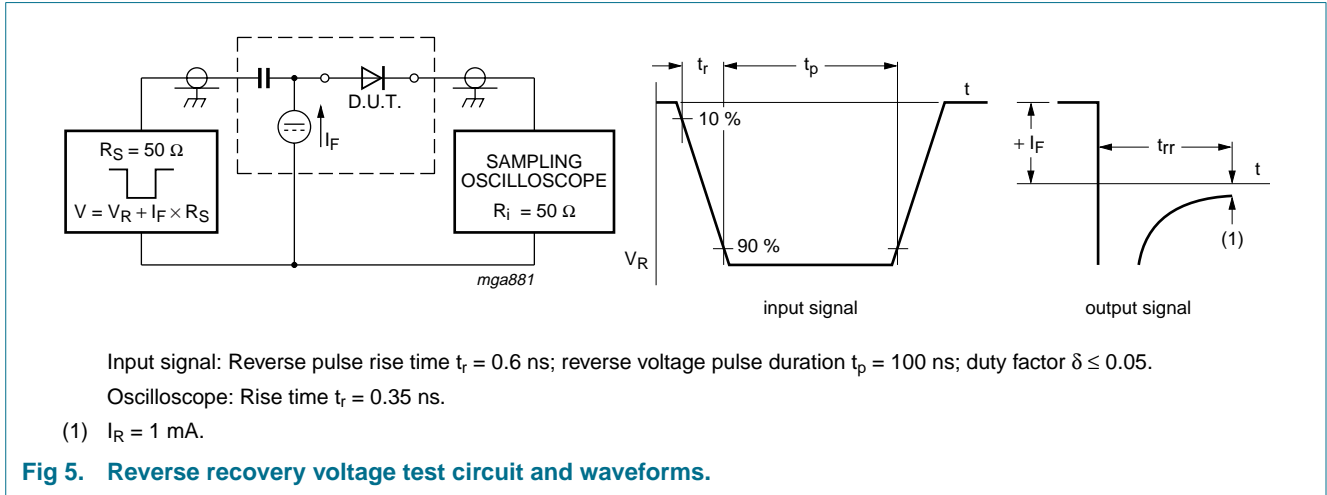

9. Package outline

Plastic surface mounted package; 6 leads

SOT666

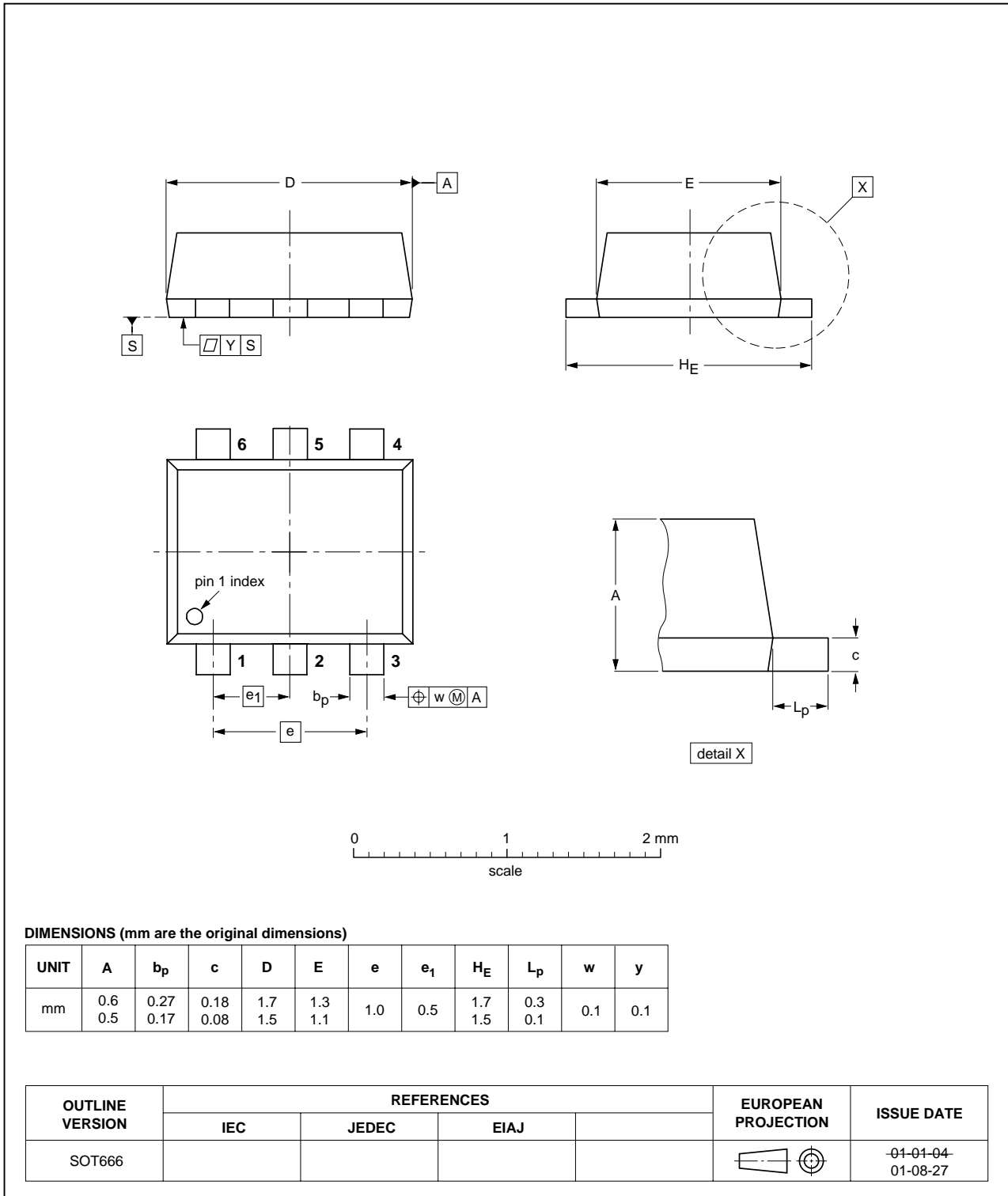

Fig 7. Package outline SOT666.

Plastic surface mounted package; 6 leads

SOT363

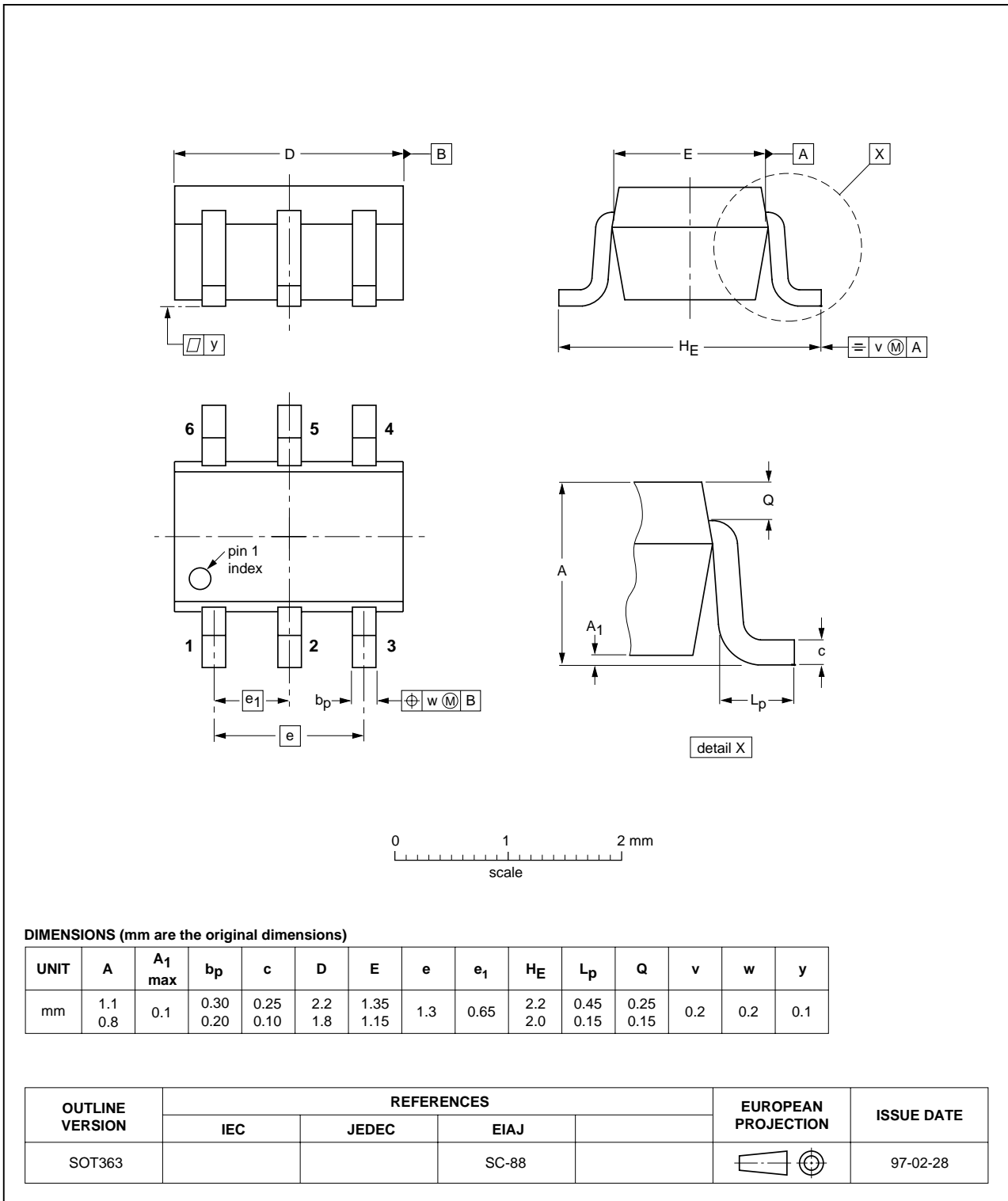

Fig 8. Package outline SOT363 (SC-88).

10. Packing information

Table 9: Packing methods

The indicated -xxx are the last three digits of the 12NC ordering code. [\[1\]](#)

Type number	Package	Description	Packing quantity		
			3000	4000	10000
BAS16VV	SOT666	4 mm pitch, 8 mm tape and reel	-	-115	-
BAS16VY	SOT363	4 mm pitch, 8 mm tape and reel; T1	-115	-	-135
		4 mm pitch, 8 mm tape and reel; T2	-125		-165

[1] For further information and the availability of packing methods, see [Section 15](#).

11. Revision history

Table 10: Revision history

Document ID	Release date	Data sheet status	Change notice	Order number	Supersedes
BAS16VV_BAS16VY_2	20040910	Product data sheet	-	9397 750 13856	BAS16VY_1
Modifications:	<ul style="list-style-type: none"> • The format of this data sheet has been redesigned to comply with the new presentation and information standard of Philips Semiconductors. • Type number BAS16VV added. • Table 2 "Quick reference data": table added. • Table 6 "Limiting values": maximum value of V_{RRM} changed from 85 V to 100 V. • Table 6 "Limiting values": maximum value of V_R changed from 75 V to 100 V. 				
BAS16VY_1	20030408	Product specification	-	9397 750 10909	-

12. Data sheet status

Level	Data sheet status ^[1]	Product status ^[2] ^[3]	Definition
I	Objective data	Development	This data sheet contains data from the objective specification for product development. Philips Semiconductors reserves the right to change the specification in any manner without notice.
II	Preliminary data	Qualification	This data sheet contains data from the preliminary specification. Supplementary data will be published at a later date. Philips Semiconductors reserves the right to change the specification without notice, in order to improve the design and supply the best possible product.
III	Product data	Production	This data sheet contains data from the product specification. Philips Semiconductors reserves the right to make changes at any time in order to improve the design, manufacturing and supply. Relevant changes will be communicated via a Customer Product/Process Change Notification (CPCN).

[1] Please consult the most recently issued data sheet before initiating or completing a design.

[2] The product status of the device(s) described in this data sheet may have changed since this data sheet was published. The latest information is available on the Internet at URL <http://www.semiconductors.philips.com>.

[3] For data sheets describing multiple type numbers, the highest-level product status determines the data sheet status.

13. Definitions

Short-form specification — The data in a short-form specification is extracted from a full data sheet with the same type number and title. For detailed information see the relevant data sheet or data handbook.

Limiting values definition — Limiting values given are in accordance with the Absolute Maximum Rating System (IEC 60134). Stress above one or more of the limiting values may cause permanent damage to the device. These are stress ratings only and operation of the device at these or at any other conditions above those given in the Characteristics sections of the specification is not implied. Exposure to limiting values for extended periods may affect device reliability.

Application information — Applications that are described herein for any of these products are for illustrative purposes only. Philips Semiconductors make no representation or warranty that such applications will be suitable for the specified use without further testing or modification.

14. Disclaimers

Life support — These products are not designed for use in life support appliances, devices, or systems where malfunction of these products can reasonably be expected to result in personal injury. Philips Semiconductors customers using or selling these products for use in such applications do so at their own risk and agree to fully indemnify Philips Semiconductors for any damages resulting from such application.

Right to make changes — Philips Semiconductors reserves the right to make changes in the products - including circuits, standard cells, and/or software - described or contained herein in order to improve design and/or performance. When the product is in full production (status 'Production'), relevant changes will be communicated via a Customer Product/Process Change Notification (CPCN). Philips Semiconductors assumes no responsibility or liability for the use of any of these products, conveys no license or title under any patent, copyright, or mask work right to these products, and makes no representations or warranties that these products are free from patent, copyright, or mask work right infringement, unless otherwise specified.

15. Contact information

For additional information, please visit: <http://www.semiconductors.philips.com>

For sales office addresses, send an email to: sales.addresses@www.semiconductors.philips.com

16. Contents

1	Product profile	1
1.1	General description.	1
1.2	Features	1
1.3	Applications	1
1.4	Quick reference data.	1
2	Pinning information	2
3	Ordering information	2
4	Marking	2
5	Limiting values	2
6	Thermal characteristics	3
7	Characteristics	4
8	Test information	6
9	Package outline	7
10	Packing information	9
11	Revision history	10
12	Data sheet status	11
13	Definitions	11
14	Disclaimers	11
15	Contact information	11



© Koninklijke Philips Electronics N.V. 2004

All rights are reserved. Reproduction in whole or in part is prohibited without the prior written consent of the copyright owner. The information presented in this document does not form part of any quotation or contract, is believed to be accurate and reliable and may be changed without notice. No liability will be accepted by the publisher for any consequence of its use. Publication thereof does not convey nor imply any license under patent- or other industrial or intellectual property rights.

Date of release: 10 September 2004
Document order number: 9397 750 13856

Published in The Netherlands