

# Battery holder for coin-type Lithium Battery

## BH820(For CR/LIR2032,2025,2016)

- \*The battery is solidly anchored in the holder
- \*Battery can be charged very easily and you are assured of reliable firm contact
- \*There is no battery damage from short circuiting or soldering.
- \*BH820 battery holder for CR and LIR series 2032 to 2025,2016.

**CONTACT:**  
0.5mm PHOSPHOR BRONZE ALLOY W/TIN PLATED

**CONTACT LOADING:**  
3 AMP

**COLOUR:**  
BLACK

**OPERATION TEMP:**  
-55°C+125°C

**DURABILITY:**  
50 CYCLES PLUG-IN-OUT (SAME TYPE)

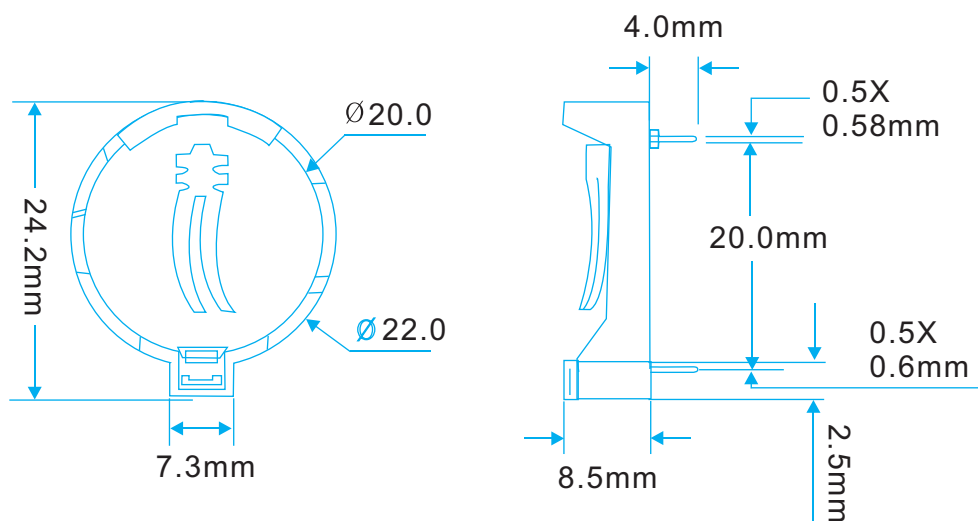

Specifications subject to change without notice