



BSS84

P-channel enhancement mode vertical DMOS transistor

Rev. 06 — 16 December 2008

Product data sheet

1. Product profile

1.1 General description

P-channel enhancement mode vertical Diffusion Metal-Oxide Semiconductor (DMOS) transistor in a small Surface-Mounted Device (SMD) plastic package.

Table 1. Product overview

Type number ^[1]	Package	
	NXP	JEDEC
BSS84	SOT23	TO-236AB
BSS84/DG		

[1] /DG: halogen-free

1.2 Features

- Low threshold voltage
- High-speed switching
- Direct interface to CMOS and Transistor-Transistor Logic (TTL)
- No secondary breakdown

1.3 Applications

- Line current interrupter in telephone sets
- Relay, high-speed and line transformer drivers

1.4 Quick reference data

- $V_{DS} \leq -50$ V
- $I_D \leq -130$ mA
- $R_{DS(on)} \leq 10$ Ω
- $P_{tot} \leq 250$ mW

2. Pinning information

Table 2. Pinning

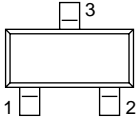
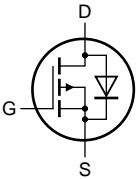
Pin	Symbol	Description	Simplified outline	Graphic symbol
1	G	gate	 <p>SOT23 (TO-236AB)</p>	 <p>001aaa025</p>
2	S	source		
3	D	drain		

3. Ordering information

Table 3. Ordering information

Type number ^[1]	Package		
	Name	Description	Version
BSS84	TO-236AB	plastic surface-mounted package; 3 leads	SOT23
BSS84/DG			

[1] /DG: halogen-free

4. Marking

Table 4. Marking codes

Type number ^[1]	Marking code ^[2]
BSS84	13*
BSS84/DG	ZV*

[1] /DG: halogen-free

[2] * = -: made in Hong Kong
 * = p: made in Hong Kong
 * = t: made in Malaysia
 * = W: made in China

5. Limiting values

Table 5. Limiting values

In accordance with the Absolute Maximum Rating System (IEC 60134).

Symbol	Parameter	Conditions	Min	Max	Unit
V_{DS}	drain-source voltage	$25\text{ °C} \leq T_j \leq 150\text{ °C}$	-	-50	V
V_{GS}	gate-source voltage		-	± 20	V
I_D	drain current	$T_{sp} = 25\text{ °C}; V_{GS} = -10\text{ V};$ see Figure 1	-	-130	mA
		$T_{sp} = 100\text{ °C};$ $V_{GS} = -10\text{ V}$	-	-75	mA
I_{DM}	peak drain current	$T_{sp} = 25\text{ °C}; t_p \leq 10\text{ }\mu\text{s};$ see Figure 1	-	-520	mA
P_{tot}	total power dissipation	$T_{sp} = 25\text{ °C};$ see Figure 2 [1]	-	250	mW
T_{stg}	storage temperature		-65	+150	°C
T_j	junction temperature		-65	+150	°C

[1] Device mounted on a Printed-Circuit Board (PCB).

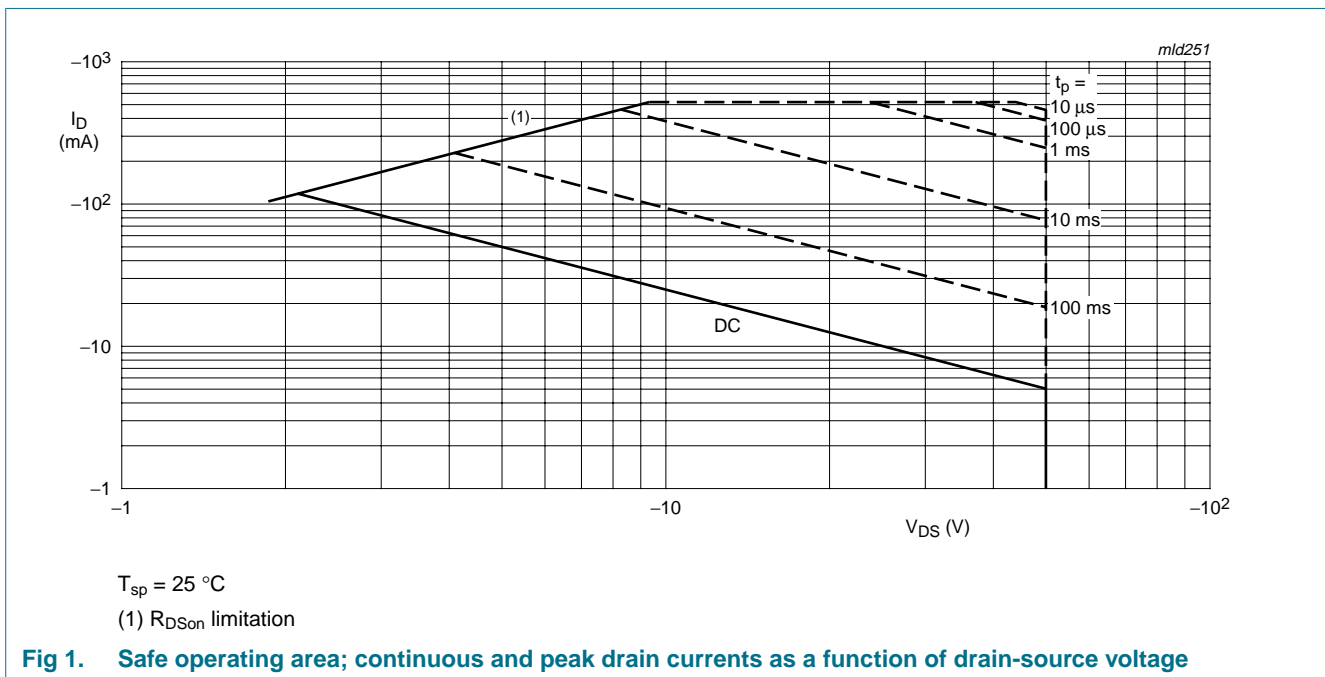

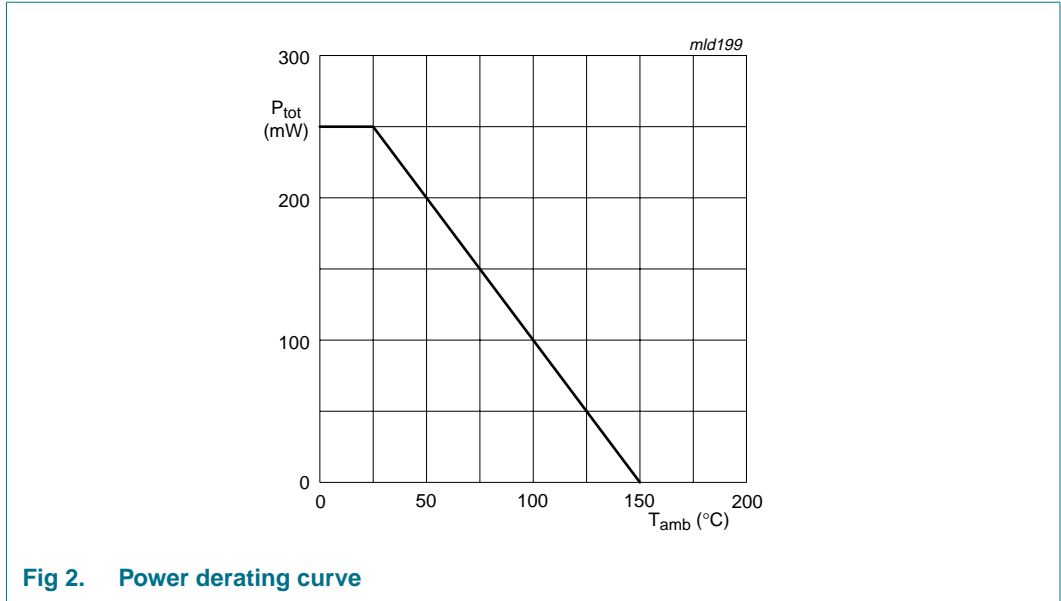

Fig 2. Power derating curve

6. Thermal characteristics

Table 6. Thermal characteristics

Symbol	Parameter	Conditions	Min	Typ	Max	Unit
R _{th(j-a)}	thermal resistance from junction to ambient	see Figure 3	[1]	-	500	K/W

[1] Mounted on a PCB, vertical in still air.

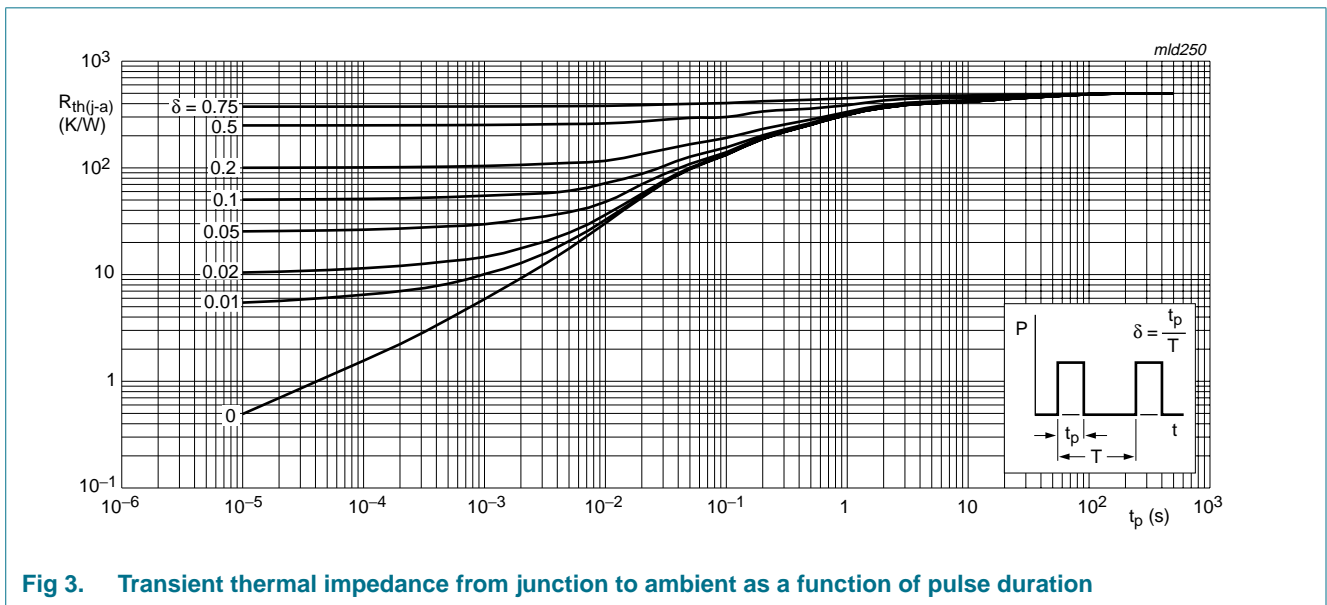

Fig 3. Transient thermal impedance from junction to ambient as a function of pulse duration

7. Characteristics

Table 7. Characteristics

$T_j = 25\text{ °C}$ unless otherwise specified.

Symbol	Parameter	Conditions	Min	Typ	Max	Unit
Static characteristics						
$V_{(BR)DSS}$	drain-source breakdown voltage	$I_D = -10\ \mu\text{A}$; $V_{GS} = 0\ \text{V}$	-50	-	-	V
$V_{GS(th)}$	gate-source threshold voltage	$I_D = -1\ \text{mA}$; $V_{DS} = V_{GS}$; see Figure 8				
		$T_j = 25\text{ °C}$	-0.8	-	-2	V
		$T_j = -55\text{ °C}$	-	-	-1.8	V
I_{DSS}	drain leakage current	$V_{DS} = -40\ \text{V}$; $V_{GS} = 0\ \text{V}$				
		$T_j = 25\text{ °C}$	-	-	-100	nA
		$V_{DS} = -50\ \text{V}$; $V_{GS} = 0\ \text{V}$				
		$T_j = 25\text{ °C}$	-	-	-10	μA
I_{GSS}	gate leakage current	$V_{GS} = +20\ \text{V}$; $V_{DS} = 0\ \text{V}$	-	-	100	nA
		$V_{GS} = -20\ \text{V}$; $V_{DS} = 0\ \text{V}$	-	-	100	nA
		$T_j = 125\text{ °C}$	-	-	-60	μA
$R_{DS(on)}$	drain-source on-state resistance	$V_{GS} = -10\ \text{V}$; $I_D = -130\ \text{mA}$; see Figure 5 and 7	-	6	10	Ω
Dynamic characteristics						
$ Y_{fs} $	transfer admittance	$V_{DS} = -25\ \text{V}$; $I_D = -130\ \text{mA}$	50	-	-	mS
C_{iss}	input capacitance	$V_{GS} = 0\ \text{V}$; $V_{DS} = -25\ \text{V}$; $f = 1\ \text{MHz}$; see Figure 9	-	25	45	pF
C_{oss}	output capacitance		-	15	25	pF
C_{rss}	reverse transfer capacitance		-	3.5	12	pF
t_{on}	turn-on time	$V_{DS} = -40\ \text{V}$; $V_{GS} = 0\ \text{V}$ to $-10\ \text{V}$; $I_D = -200\ \text{mA}$; see Figure 10 and 11	-	3	-	ns
t_{off}	turn-off time	$V_{DS} = -40\ \text{V}$; $V_{GS} = -10\ \text{V}$ to $0\ \text{V}$; $I_D = -200\ \text{mA}$; see Figure 10 and 11	-	7	-	ns

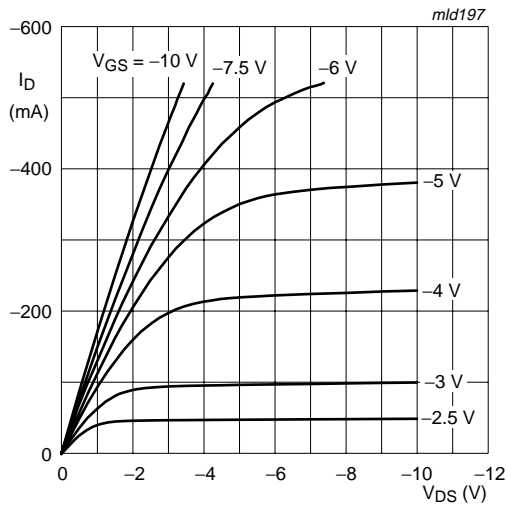

$T_j = 25\text{ }^\circ\text{C}$

Fig 4. Output characteristics: drain current as a function of drain-source voltage; typical values

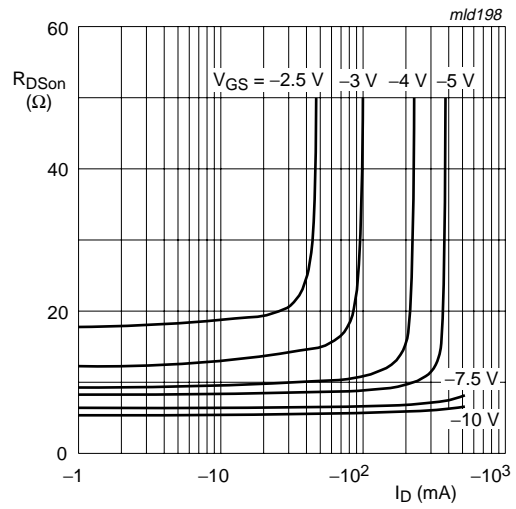

$T_j = 25\text{ }^\circ\text{C}$

Fig 5. Drain-source on-state resistance as a function of drain current; typical values

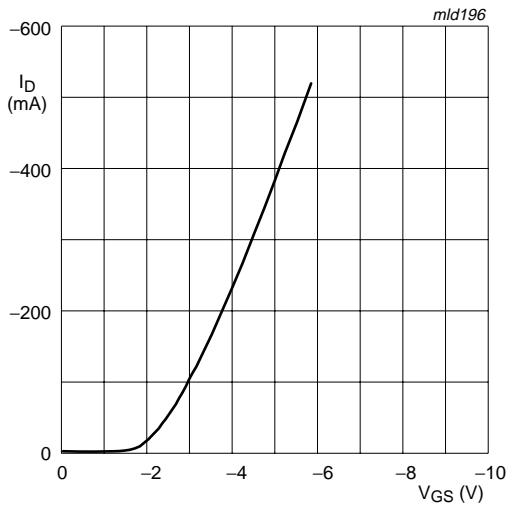

$T_j = 25\text{ }^\circ\text{C}; V_{DS} = -10\text{ V}$

Fig 6. Transfer characteristics: drain current as a function of gate-source voltage; typical values

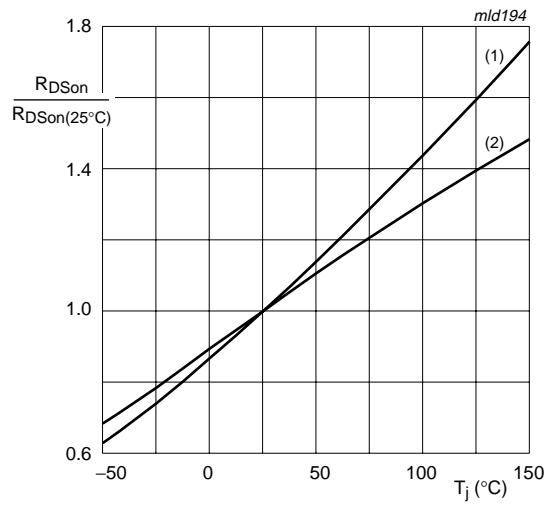

(1) $I_D = -130\text{ mA}; V_{GS} = -10\text{ V}$
 (2) $I_D = -20\text{ mA}; V_{GS} = -2.4\text{ V}$

Fig 7. Normalized drain-source on-state resistance factor as a function of junction temperature

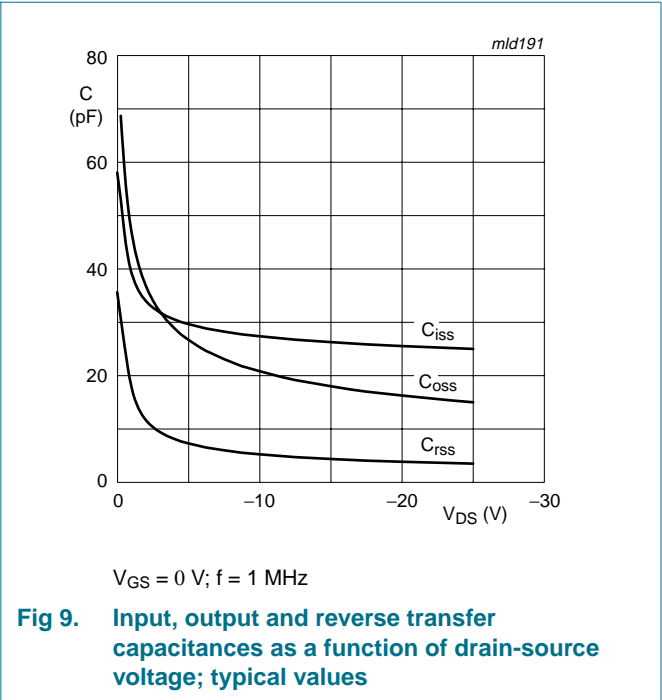
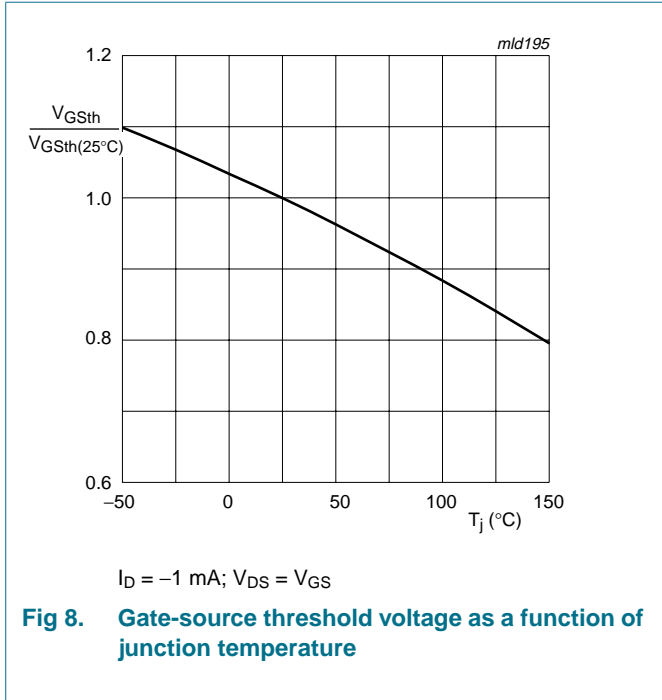

8. Test information

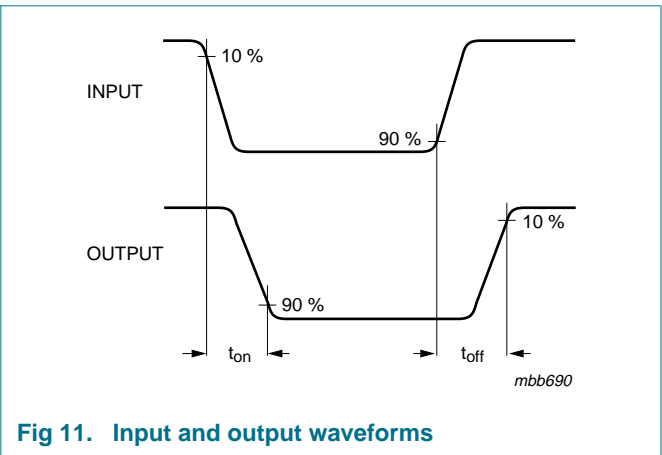
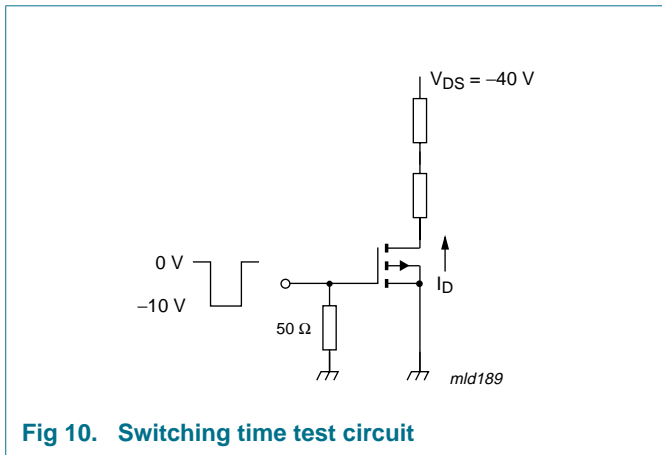

9. Package outline

Plastic surface-mounted package; 3 leads

SOT23

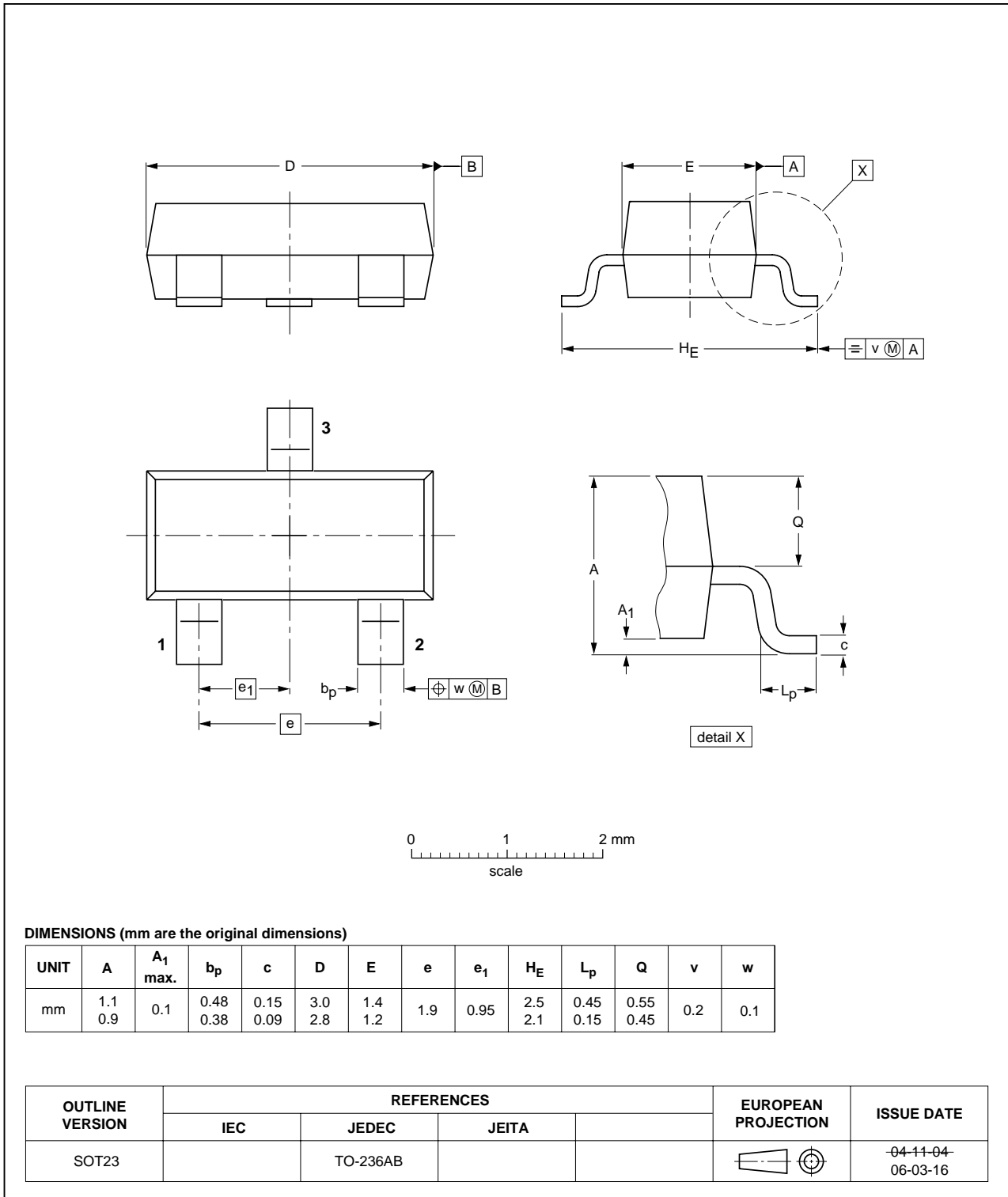

Fig 12. Package outline SOT23 (TO-236AB)

10. Revision history

Table 8. Revision history

Document ID	Release date	Data sheet status	Change notice	Supersedes
BSS84_6	20081216	Product data sheet	-	BSS84_5
Modifications:	• Table 5 “Limiting values” : P _{tot} figure reference updated			
BSS84_5	20081209	Product data sheet	-	BSS84_4
BSS84_4	20070717	Product data sheet	-	BSS84_3
BSS84_3	20030804	Product specification	-	BSS84_2
BSS84_2	19970618	Product specification	-	BSS84_1
BSS84_1	19950407	Product specification	-	-

11. Legal information

11.1 Data sheet status

Document status ^{[1][2]}	Product status ^[3]	Definition
Objective [short] data sheet	Development	This document contains data from the objective specification for product development.
Preliminary [short] data sheet	Qualification	This document contains data from the preliminary specification.
Product [short] data sheet	Production	This document contains the product specification.

[1] Please consult the most recently issued document before initiating or completing a design.

[2] The term 'short data sheet' is explained in section "Definitions".

[3] The product status of device(s) described in this document may have changed since this document was published and may differ in case of multiple devices. The latest product status information is available on the Internet at URL <http://www.nxp.com>.

11.2 Definitions

Draft — The document is a draft version only. The content is still under internal review and subject to formal approval, which may result in modifications or additions. NXP Semiconductors does not give any representations or warranties as to the accuracy or completeness of information included herein and shall have no liability for the consequences of use of such information.

Short data sheet — A short data sheet is an extract from a full data sheet with the same product type number(s) and title. A short data sheet is intended for quick reference only and should not be relied upon to contain detailed and full information. For detailed and full information see the relevant full data sheet, which is available on request via the local NXP Semiconductors sales office. In case of any inconsistency or conflict with the short data sheet, the full data sheet shall prevail.

11.3 Disclaimers

General — Information in this document is believed to be accurate and reliable. However, NXP Semiconductors does not give any representations or warranties, expressed or implied, as to the accuracy or completeness of such information and shall have no liability for the consequences of use of such information.

Right to make changes — NXP Semiconductors reserves the right to make changes to information published in this document, including without limitation specifications and product descriptions, at any time and without notice. This document supersedes and replaces all information supplied prior to the publication hereof.

Suitability for use — NXP Semiconductors products are not designed, authorized or warranted to be suitable for use in medical, military, aircraft, space or life support equipment, nor in applications where failure or malfunction of an NXP Semiconductors product can reasonably be expected to result in personal injury, death or severe property or environmental

damage. NXP Semiconductors accepts no liability for inclusion and/or use of NXP Semiconductors products in such equipment or applications and therefore such inclusion and/or use is at the customer's own risk.

Applications — Applications that are described herein for any of these products are for illustrative purposes only. NXP Semiconductors makes no representation or warranty that such applications will be suitable for the specified use without further testing or modification.

Limiting values — Stress above one or more limiting values (as defined in the Absolute Maximum Ratings System of IEC 60134) may cause permanent damage to the device. Limiting values are stress ratings only and operation of the device at these or any other conditions above those given in the Characteristics sections of this document is not implied. Exposure to limiting values for extended periods may affect device reliability.

Terms and conditions of sale — NXP Semiconductors products are sold subject to the general terms and conditions of commercial sale, as published at <http://www.nxp.com/profile/terms>, including those pertaining to warranty, intellectual property rights infringement and limitation of liability, unless explicitly otherwise agreed to in writing by NXP Semiconductors. In case of any inconsistency or conflict between information in this document and such terms and conditions, the latter will prevail.

No offer to sell or license — Nothing in this document may be interpreted or construed as an offer to sell products that is open for acceptance or the grant, conveyance or implication of any license under any copyrights, patents or other industrial or intellectual property rights.

Quick reference data — The Quick reference data is an extract of the product data given in the Limiting values and Characteristics sections of this document, and as such is not complete, exhaustive or legally binding.

11.4 Trademarks

Notice: All referenced brands, product names, service names and trademarks are the property of their respective owners.

12. Contact information

For more information, please visit: <http://www.nxp.com>

For sales office addresses, please send an email to: salesaddresses@nxp.com

13. Contents

1	Product profile	1
1.1	General description	1
1.2	Features	1
1.3	Applications	1
1.4	Quick reference data	1
2	Pinning information	2
3	Ordering information	2
4	Marking	2
5	Limiting values	3
6	Thermal characteristics	4
7	Characteristics	5
8	Test information	7
9	Package outline	8
10	Revision history	9
11	Legal information	10
11.1	Data sheet status	10
11.2	Definitions	10
11.3	Disclaimers	10
11.4	Trademarks	10
12	Contact information	10
13	Contents	11

Please be aware that important notices concerning this document and the product(s) described herein, have been included in section 'Legal information'.



© NXP B.V. 2008.

All rights reserved.

For more information, please visit: <http://www.nxp.com>

For sales office addresses, please send an email to: salesaddresses@nxp.com

Date of release: 16 December 2008

Document identifier: BSS84_6