

BTA204S series D, E and F

Three-quadrant triacs guaranteed commutation

Rev. 05 — 16 February 2006

Product data sheet

1. Product profile

1.1 General description

Passivated guaranteed commutation triacs in a SOT428 (DPAK) plastic package intended for use in motor control circuits or with other highly inductive loads. These devices balance the requirements of commutation performance and gate sensitivity. The “logic level” D series is intended for interfacing with low power drivers, including microcontrollers.

1.2 Features

- High gate sensitivity
- Guaranteed commutation capability

1.3 Applications

- Motor control
- Industrial and domestic heating

1.4 Quick reference data

- $V_{DRM} \leq 600$ V (BTA204S-600D)
- $V_{DRM} \leq 600$ V (BTA204S-600E)
- $V_{DRM} \leq 600$ V (BTA204S-600F)
- $V_{DRM} \leq 800$ V (BTA204S-800E)
- $I_{TSM} \leq 25$ A ($t = 20$ ms)
- $I_{T(RMS)} \leq 4$ A
- $I_{GT} \leq 5$ mA (BTA204S-600D)
- $I_{GT} \leq 10$ mA (BTA204S-600E_800E)
- $I_{GT} \leq 25$ mA (BTA204S-600F)

2. Pinning information

Table 1: Pinning

Pin	Description	Simplified outline	Symbol
1	main terminal 1 (T1)	<p>SOT428 (DPAK)</p>	<p>sym051</p>
2	main terminal 2 (T2)		
3	gate (G)		
mb	mounting base [1]		

[1] Connected to main terminal 2 (T2)

3. Ordering information

Table 2: Ordering information

Type number	Package		Version
	Name	Description	
BTA204S-600D	DPAK	plastic single-ended surface mounted package (DPAK); 3 leads (one lead cropped)	SOT428
BTA204S-600E			
BTA204S-600F			
BTA204S-800E			

4. Limiting values

Table 3: Limiting values

In accordance with the Absolute Maximum Rating System (IEC 60134).

Symbol	Parameter	Conditions	Min	Max	Unit
V_{DRM}	repetitive peak off-state voltage	BTA204S-600D	[1] -	600	V
		BTA204S-600E	[1] -	600	V
		BTA204S-600F	[1] -	600	V
		BTA204S-800E	-	800	V
$I_{\text{T(RMS)}}$	RMS on-state current	full sine wave; $T_{\text{mb}} \leq 107 \text{ }^\circ\text{C}$; see Figure 4 and 5	-	4	A
I_{TSM}	non-repetitive peak on-state current	full sine wave; $T_{\text{j}} = 25 \text{ }^\circ\text{C}$ prior to surge; see Figure 2 and 3	-	-	-
		$t = 20 \text{ ms}$	-	25	A
		$t = 16.7 \text{ ms}$	-	27	A
I^2t	I^2t for fusing	$t = 10 \text{ ms}$	-	3.1	A^2s
di_{T}/dt	rate of rise of on-state current	$I_{\text{TM}} = 6 \text{ A}$; $I_{\text{G}} = 0.2 \text{ A}$; $di_{\text{G}}/dt = 0.2 \text{ A}/\mu\text{s}$	-	100	$\text{A}/\mu\text{s}$
I_{GM}	peak gate current		-	2	A
V_{GM}	peak gate voltage		-	5	V
P_{GM}	peak gate power		-	5	W
$P_{\text{G(AV)}}$	average gate power	over any 20 ms period	-	0.5	W
T_{stg}	storage temperature		-40	+150	$^\circ\text{C}$
T_{j}	junction temperature		-	125	$^\circ\text{C}$

[1] Although not recommended, off-state voltages up to 800 V may be applied without damage, but the triac may switch to the on-state. The rate of rise of current should not exceed 6 A/ μs .

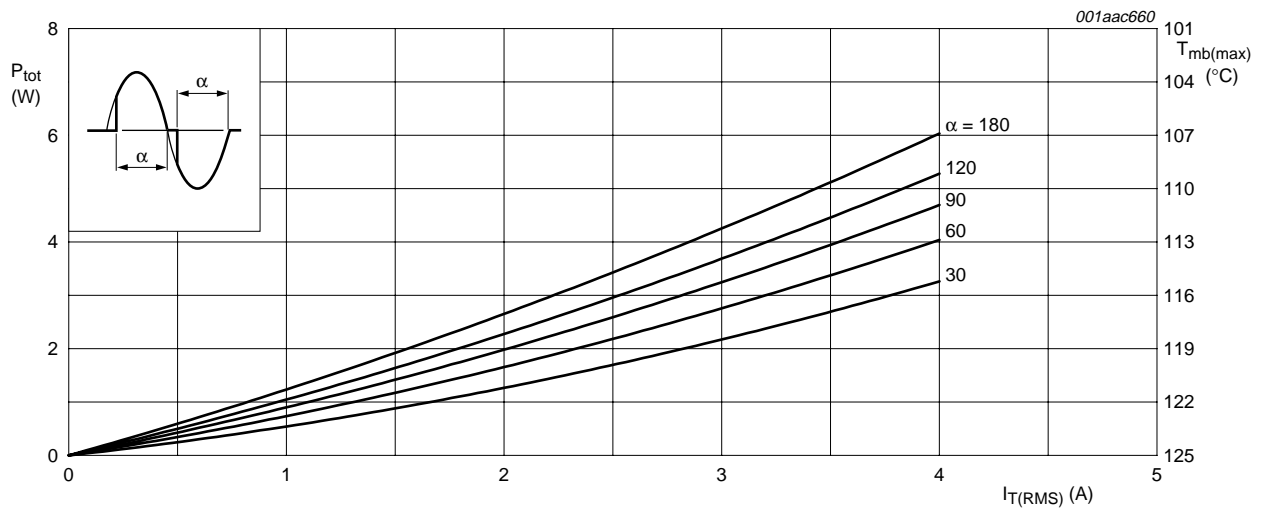

α = conduction angle

Fig 1. Total power dissipation as a function of RMS on-state current; maximum values

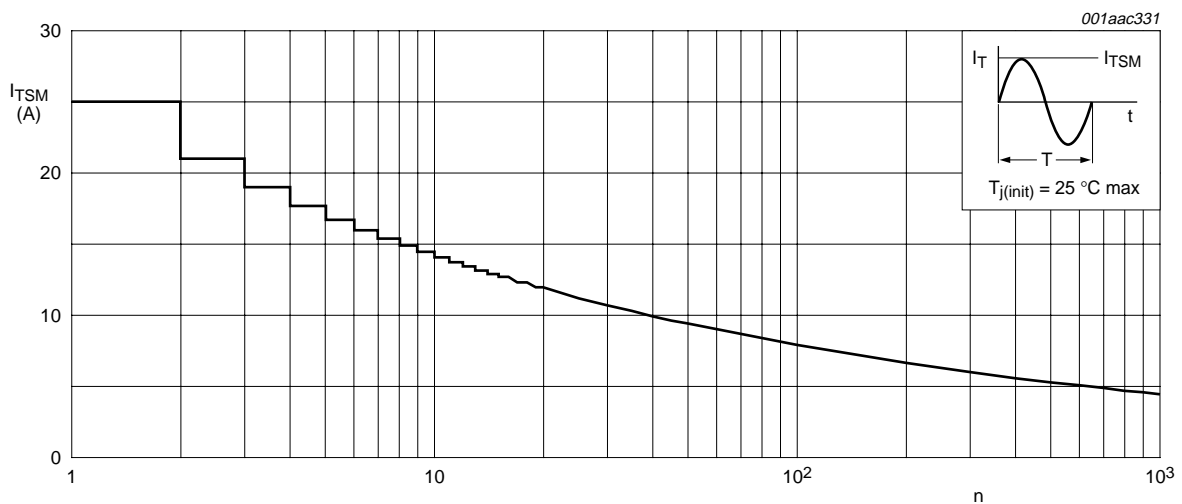

$f = 50$ Hz

Fig 2. Non-repetitive peak on-state current as a function of the number of sinusoidal current cycles; maximum values

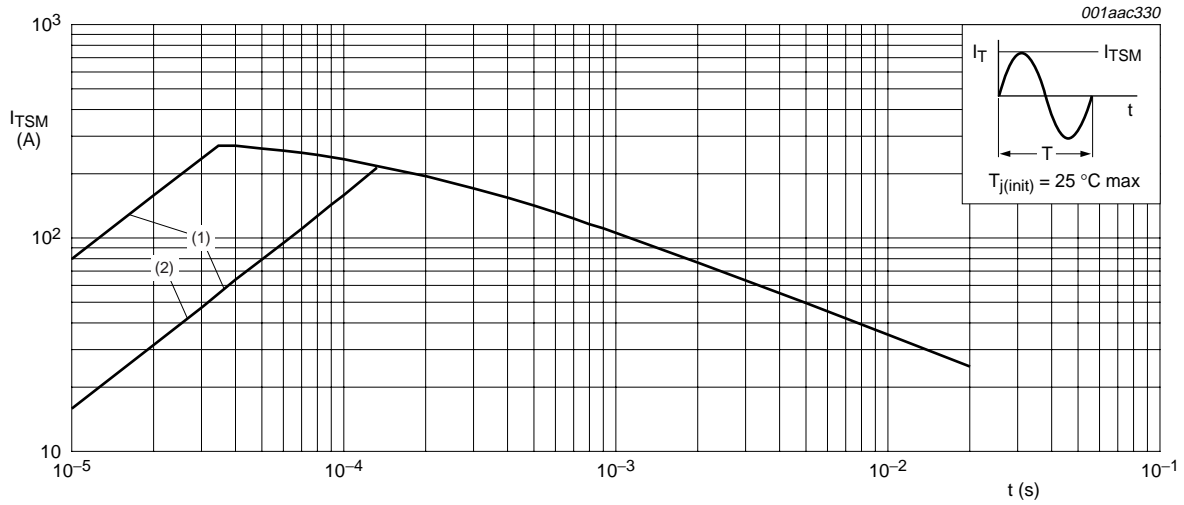

$t_p \leq 20\text{ ms}$

- (1) dl_T/dt limit
- (2) T2- G+ quadrant

Fig 3. Non-repetitive peak on-state current as a function of pulse duration; maximum values

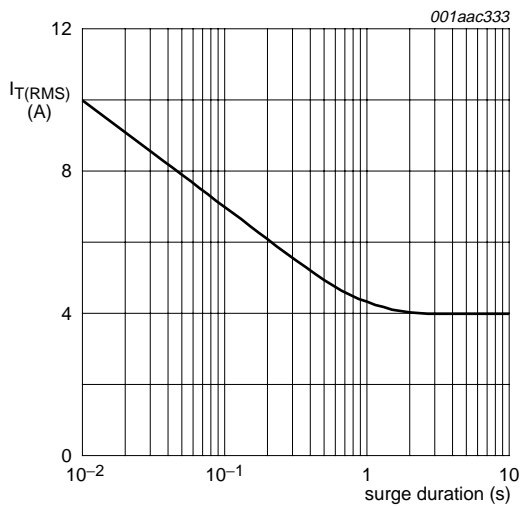

$f = 50\text{ Hz}; T_{mb} \leq 107\text{ }^{\circ}\text{C}$

Fig 4. RMS on-state current as a function of surge duration; maximum values

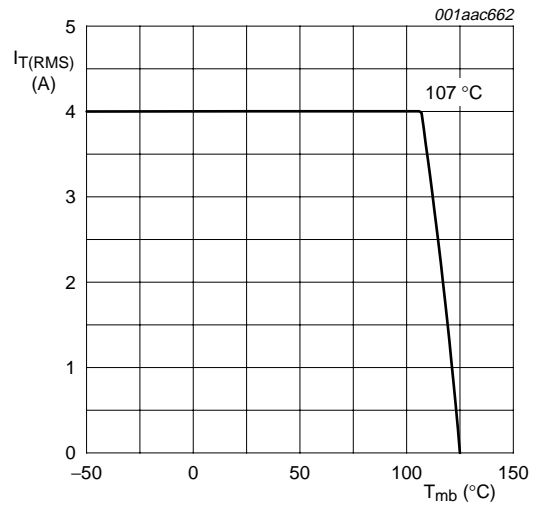

(1) $T_{mb} \leq 107\text{ }^{\circ}\text{C}$

Fig 5. RMS on-state current as a function of mounting base temperature; maximum values

5. Thermal characteristics

Table 4: Thermal characteristics

Symbol	Parameter	Conditions	Min	Typ	Max	Unit
$R_{th(j-mb)}$	thermal resistance from junction to mounting base	full cycle; see Figure 6	-	-	3.0	K/W
		half cycle; see Figure 6	-	-	3.7	K/W
$R_{th(j-a)}$	thermal resistance from junction to ambient	printed-circuit board (FR4) mounted; see Figure 13	-	75	-	K/W

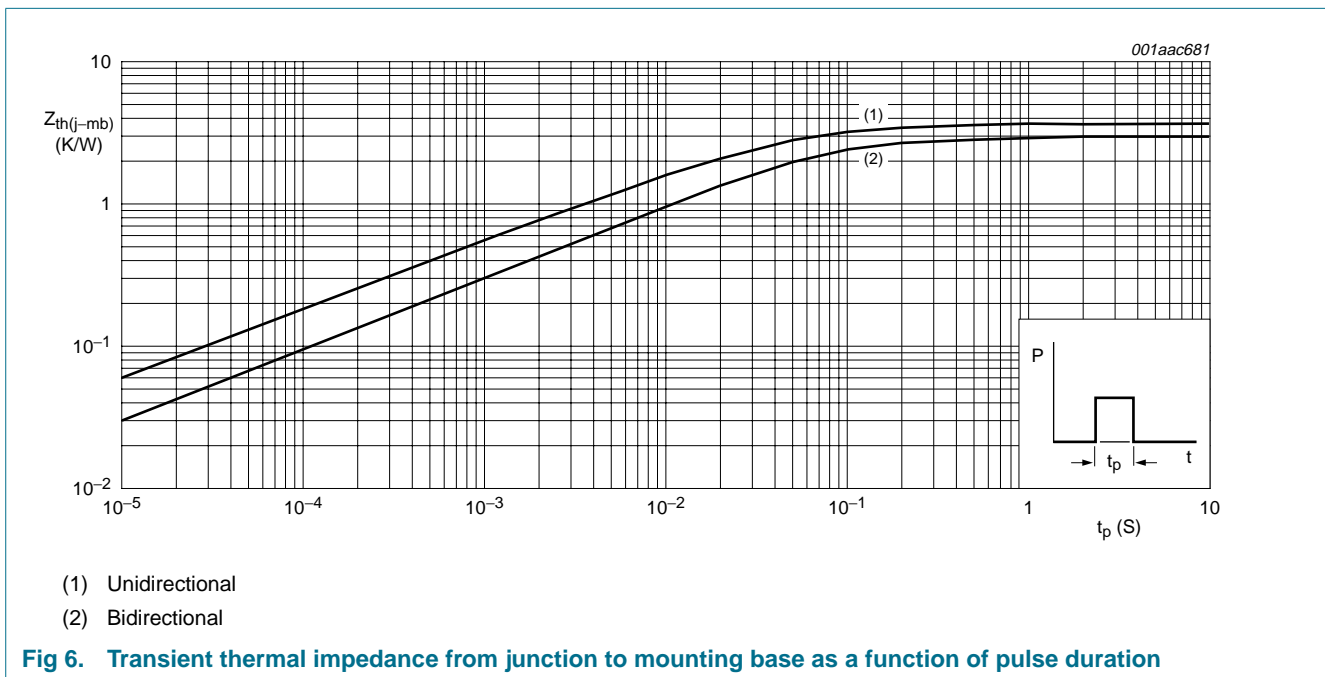

6. Static characteristics

Table 5: Static characteristics
T_j = 25 °C unless otherwise specified.

Symbol	Parameter	Conditions	BTA204S-600D			BTA204S-600E BTA204S-800E			BTA204S-600F			Unit
			Min	Typ	Max	Min	Typ	Max	Min	Typ	Max	
I _{GT}	gate trigger current	V _D = 12 V; I _T = 0.1 A; see Figure 8										
		T2+ G+	-	-	5	-	-	10	-	-	25	mA
		T2+ G-	-	-	5	-	-	10	-	-	25	mA
		T2- G-	-	-	5	-	-	10	-	-	25	mA
I _L	latching current	V _D = 12 V; I _{GT} = 0.1 A; see Figure 10										
		T2+ G+	-	-	6	-	-	12	-	-	20	mA
		T2+ G-	-	-	9	-	-	18	-	-	30	mA
		T2- G-	-	-	6	-	-	12	-	-	20	mA
I _H	holding current	V _D = 12 V; I _{GT} = 0.1 A; see Figure 11	-	-	6	-	-	12	-	-	20	mA
V _T	on-state voltage	I _T = 5 A; see Figure 9	-	1.4	1.7	-	1.4	1.7	-	1.4	1.7	V
V _{GT}	gate trigger voltage	V _D = 12 V; I _T = 0.1 A; see Figure 7	-	0.7	1.5	-	0.7	1.5	-	0.7	1.5	V
		V _D = 400 V; I _T = 0.1 A; T _j = 125 °C	0.25	0.4	-	0.25	0.4	-	0.25	0.4	-	V
I _D	off-state current	V _D = V _{DRM(max)} ; T _j = 125 °C	-	0.1	0.5	-	0.1	0.5	-	0.1	0.5	mA

7. Dynamic characteristics

Table 6: Dynamic characteristics

Symbol	Parameter	Conditions	BTA204S-600D			BTA204S-600E BTA204S-800E			BTA204S-600F			Unit
			Min	Typ	Max	Min	Typ	Max	Min	Typ	Max	
dV_D/dt	rate of rise of off-state voltage	$V_{DM} = 0.67V_{DRM(max)}$; $T_j = 125\text{ }^\circ\text{C}$; exponential waveform; gate open circuit	20	-	-	30	-	-	50	-	-	V/ μs
dl_{com}/dt	rate of change of commutating current	$V_{DM} = 400\text{ V}$; $T_j = 125\text{ }^\circ\text{C}$; $I_{T(RMS)} = 4\text{ A}$; $dV_{com}/dt = 10\text{ V}/\mu\text{s}$; gate open circuit	1.1	-	-	2.1	-	-	3	-	-	A/ms
		$V_{DM} = 400\text{ V}$; $T_j = 125\text{ }^\circ\text{C}$; $I_{T(RMS)} = 4\text{ A}$; $dV_{com}/dt = 0.1\text{ V}/\mu\text{s}$; gate open circuit	4.5	-	-	8	-	-	15	-	-	A/ms
t_{gt}	gate-controlled turn-on time	$I_{TM} = 12\text{ A}$; $V_D = V_{DRM(max)}$; $I_G = 0.1\text{ A}$; $dl_G/dt = 5\text{ A}/\mu\text{s}$	-	2	-	-	2	-	-	2	-	μs

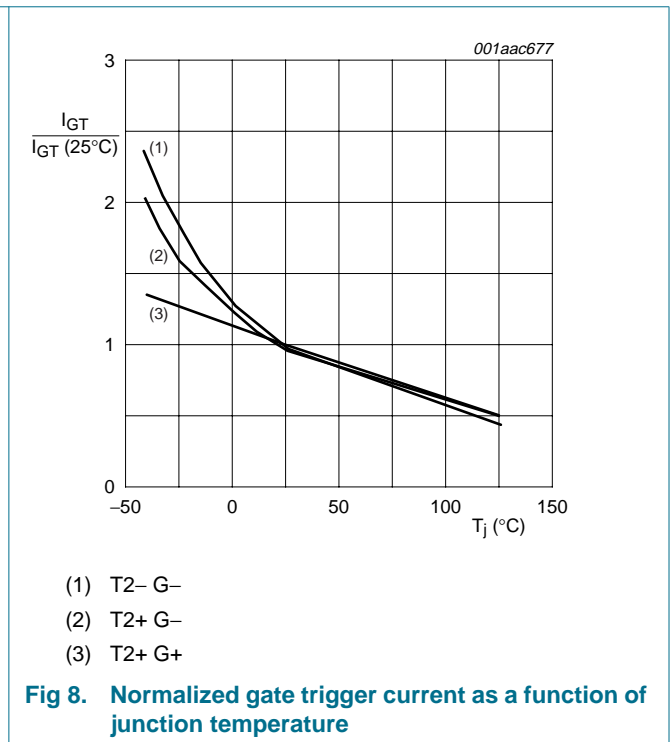
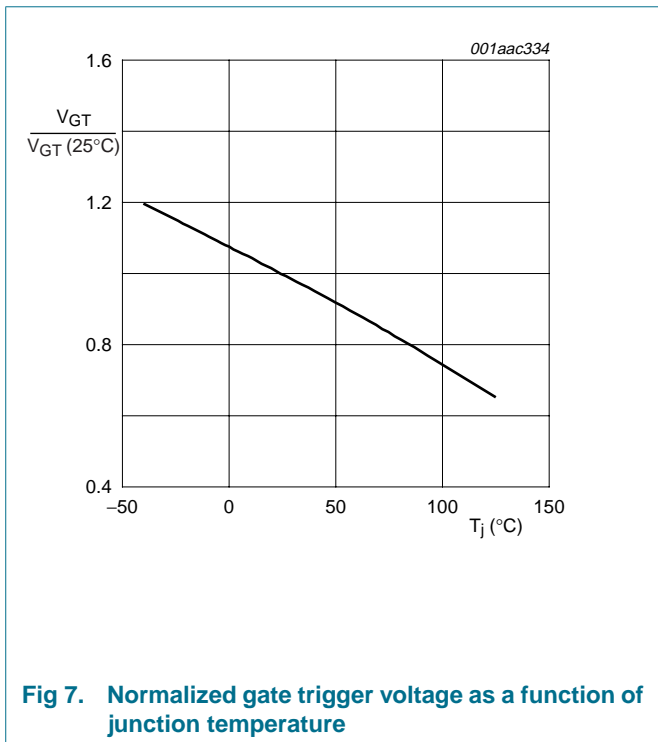

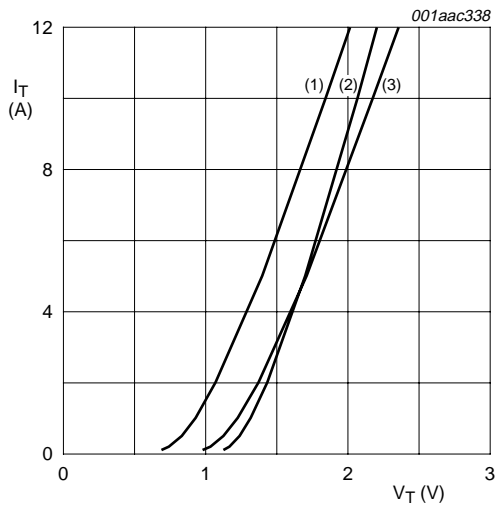

$V_o = 1.27 \text{ V}$

$R_s = 0.091 \text{ } \Omega$

- (1) $T_j = 125 \text{ }^\circ\text{C}$; typical values
- (2) $T_j = 25 \text{ }^\circ\text{C}$; maximum values
- (3) $T_j = 125 \text{ }^\circ\text{C}$; maximum values

Fig 9. On-state current as a function of on-state voltage

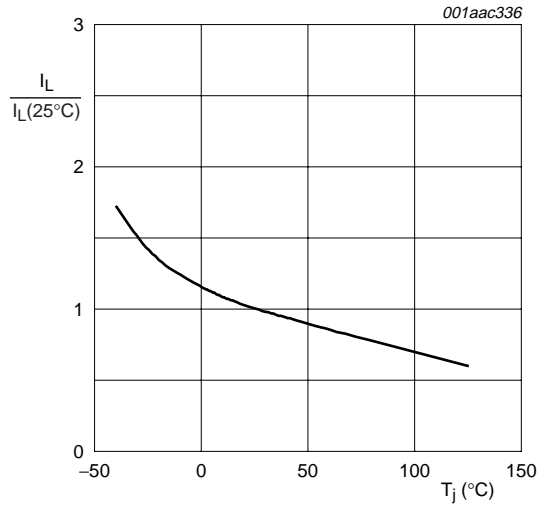

Fig 10. Normalized latching current as a function of junction temperature

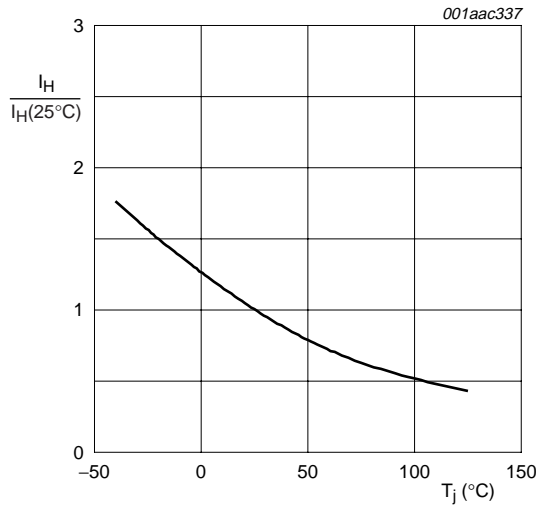

Fig 11. Normalized holding current as a function of junction temperature

8. Package information

Refer to mounting instructions for SOT428 (DPAK) packages. Epoxy meets UL94 V-0 at 1/8 inch.

9. Package outline

Plastic single-ended surface mounted package (DPAK); 3 leads (one lead cropped)

SOT428

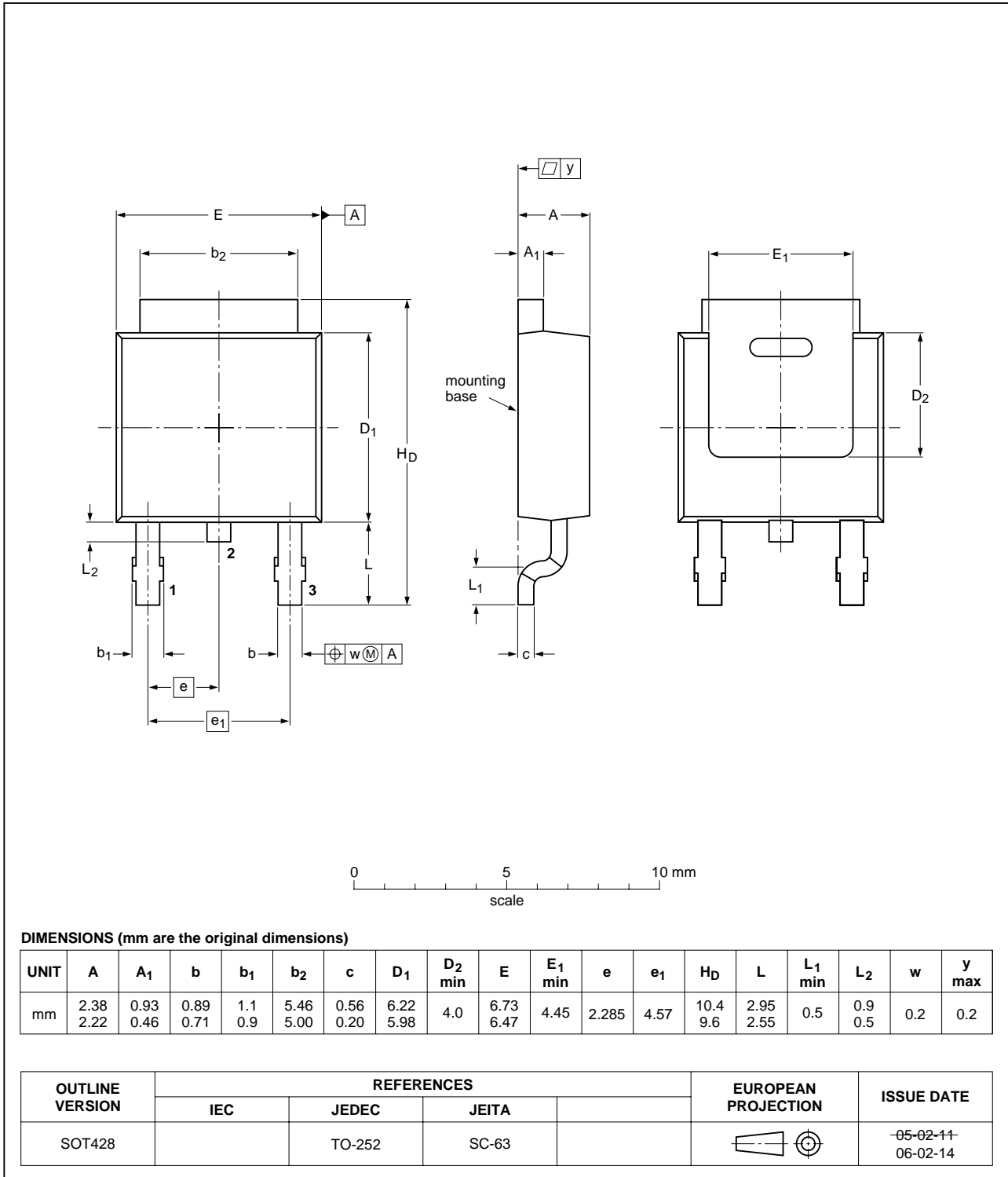
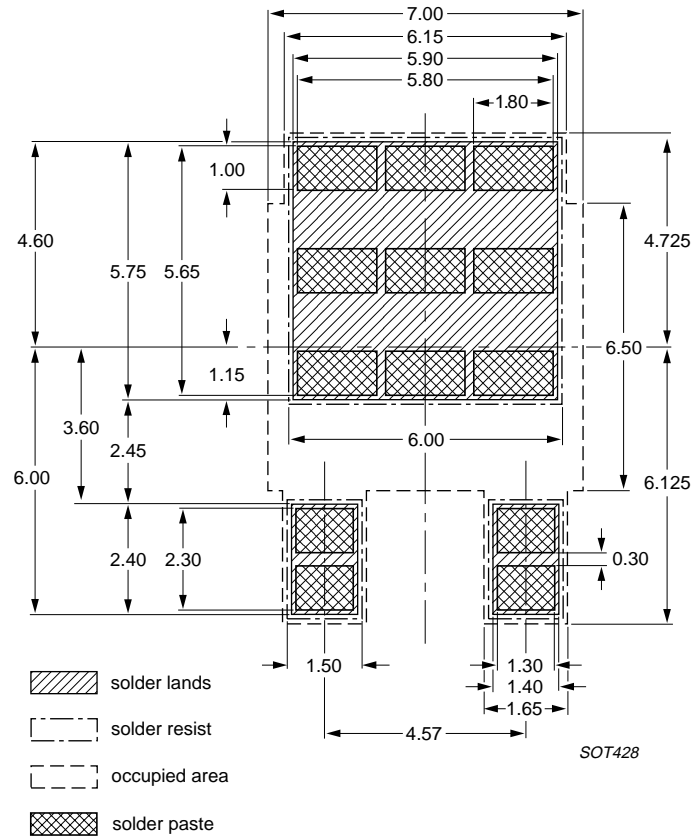

Fig 12. Package outline SOT428 (DPAK)

10. Mounting



All dimensions are in mm

Fig 13. Reflow soldering footprint SOT428 (DPAK)

11. Revision history

Table 7: Revision history

Document ID	Release date	Data sheet status	Change notice	Doc. number	Supersedes
BTA204S_SER_D_E_F_5	20060216	Product data sheet	-	-	BTA204S_SER_D_E_F_4
Modifications:					<ul style="list-style-type: none"> The format of this data sheet has been redesigned to comply with the new presentation and information standard of Philips Semiconductors. Addition of BTA204S-800E
BTA204S_SER_D_E_F_4	20030501	Product specification	-	-	BTA204S_SER_D_E_F_3
BTA204S_SER_D_E_F_3	19981201	Product specification	-	9397 750 06619	BTA204S_SER_D_E_F_2
BTA204S_SER_D_E_F_2	19981201	Product specification	-	-	BTA204S_SER_D_E_F_1
BTA204S_SER_D_E_F_1	19970901	Objective specification	-	-	-

12. Data sheet status

Level	Data sheet status ^[1]	Product status ^{[2] [3]}	Definition
I	Objective data	Development	This data sheet contains data from the objective specification for product development. Philips Semiconductors reserves the right to change the specification in any manner without notice.
II	Preliminary data	Qualification	This data sheet contains data from the preliminary specification. Supplementary data will be published at a later date. Philips Semiconductors reserves the right to change the specification without notice, in order to improve the design and supply the best possible product.
III	Product data	Production	This data sheet contains data from the product specification. Philips Semiconductors reserves the right to make changes at any time in order to improve the design, manufacturing and supply. Relevant changes will be communicated via a Customer Product/Process Change Notification (CPCN).

[1] Please consult the most recently issued data sheet before initiating or completing a design.

[2] The product status of the device(s) described in this data sheet may have changed since this data sheet was published. The latest information is available on the Internet at URL <http://www.semiconductors.philips.com>.

[3] For data sheets describing multiple type numbers, the highest-level product status determines the data sheet status.

13. Definitions

Short-form specification — The data in a short-form specification is extracted from a full data sheet with the same type number and title. For detailed information see the relevant data sheet or data handbook.

Limiting values definition — Limiting values given are in accordance with the Absolute Maximum Rating System (IEC 60134). Stress above one or more of the limiting values may cause permanent damage to the device. These are stress ratings only and operation of the device at these or at any other conditions above those given in the Characteristics sections of the specification is not implied. Exposure to limiting values for extended periods may affect device reliability.

Application information — Applications that are described herein for any of these products are for illustrative purposes only. Philips Semiconductors makes no representation or warranty that such applications will be suitable for the specified use without further testing or modification.

14. Disclaimers

Life support — These products are not designed for use in life support appliances, devices, or systems where malfunction of these products can reasonably be expected to result in personal injury. Philips Semiconductors

16. Contact information

For additional information, please visit: <http://www.semiconductors.philips.com>

For sales office addresses, send an email to: sales.addresses@www.semiconductors.philips.com

customers using or selling these products for use in such applications do so at their own risk and agree to fully indemnify Philips Semiconductors for any damages resulting from such application.

Right to make changes — Philips Semiconductors reserves the right to make changes in the products - including circuits, standard cells, and/or software - described or contained herein in order to improve design and/or performance. When the product is in full production (status 'Production'), relevant changes will be communicated via a Customer Product/Process Change Notification (CPCN). Philips Semiconductors assumes no responsibility or liability for the use of any of these products, conveys no license or title under any patent, copyright, or mask work right to these products, and makes no representations or warranties that these products are free from patent, copyright, or mask work right infringement, unless otherwise specified.

15. Trademarks

Notice — All referenced brands, product names, service names and trademarks are the property of their respective owners.

17. Contents

1	Product profile	1
1.1	General description	1
1.2	Features	1
1.3	Applications	1
1.4	Quick reference data	1
2	Pinning information	1
3	Ordering information	2
4	Limiting values	2
5	Thermal characteristics	5
6	Static characteristics	6
7	Dynamic characteristics	7
8	Package information	8
9	Package outline	9
10	Mounting	10
11	Revision history	11
12	Data sheet status	12
13	Definitions	12
14	Disclaimers	12
15	Trademarks	12
16	Contact information	12



© Koninklijke Philips Electronics N.V. 2006

All rights are reserved. Reproduction in whole or in part is prohibited without the prior written consent of the copyright owner. The information presented in this document does not form part of any quotation or contract, is believed to be accurate and reliable and may be changed without notice. No liability will be accepted by the publisher for any consequence of its use. Publication thereof does not convey nor imply any license under patent- or other industrial or intellectual property rights.

Date of release: 16 February 2006
Document number: BTA204S_SER_D_E_F_5

Published in The Netherlands