

# C3D08060A–Silicon Carbide Schottky Diode

## Z-REC™ RECTIFIER

$V_{RRM} = 600\text{ V}$   
 $I_{F(AVG)} = 8\text{ A}$   
 $(T_c < 150^\circ\text{C})$   
 $Q_c = 21\text{ nC}$

### Features

- 600-Volt Schottky Rectifier
- Zero Reverse Recovery Current
- Zero Forward Recovery Voltage
- High-Frequency Operation
- Temperature-Independent Switching Behavior
- Extremely Fast Switching
- Positive Temperature Coefficient on  $V_F$

### Benefits

- Replace Bipolar with Unipolar Rectifiers
- Essentially No Switching Losses
- Higher Efficiency
- Reduction of Heat Sink Requirements
- Parallel Devices Without Thermal Runaway

### Applications

- Switch Mode Power Supplies
- Power Factor Correction
  - Typical PFC  $P_{out}$  : 800W-1600W
- Motor Drives
  - Typical Power : 3HP-4HP

### Package

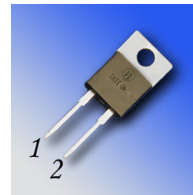

TO-220-2

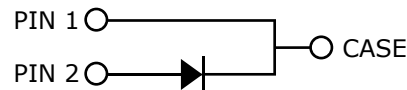

Part Number	Package	Marking
C3D08060A	TO-220-2	C3D08060

### Maximum Ratings

Symbol	Parameter	Value	Unit	Test Conditions	Note
$V_{RRM}$	Repetitive Peak Reverse Voltage	600	V		
$V_{RSM}$	Surge Peak Reverse Voltage	600	V		
$V_{DC}$	DC Blocking Voltage	600	V		
$I_{F(AVG)}$	Average Forward Current	8 10	A	$T_c < 150^\circ\text{C}$ $T_c < 135^\circ\text{C}$	See Fig. 3
$I_{FRM}$	Repetitive Peak Forward Surge Current	57 36	A	$T_c=25^\circ\text{C}$ , $t_p = 10\text{ ms}$ , Half Sine Wave, $D=0.3$ $T_c=110^\circ\text{C}$ , $t_p=10\text{ ms}$ , Half Sine Wave, $D=0.3$	
$I_{FSM}$	Non-Repetitive Peak Forward Surge Current	80 60	A	$T_c=25^\circ\text{C}$ , $t_p = 10\text{ ms}$ , Half Sine Wave, $D=0.3$ $T_c=110^\circ\text{C}$ , $t_p=10\text{ ms}$ , Half Sine Wave, $D=0.3$	
$I_{FSM}$	Non-Repetitive Peak Forward Surge Current	220	A	$T_c=25^\circ\text{C}$ , $t_p = 10\text{ }\mu\text{s}$ , Pulse	
$P_{tot}$	Power Dissipation	100 43	W	$T_c=25^\circ\text{C}$ $T_c=110^\circ\text{C}$	
$T_j, T_{stg}$	Operating Junction and Storage Temperature	-55 to +175	$^\circ\text{C}$		
	TO-220 Mounting Torque	1 8.8	Nm lbf-in	M3 Screw 6-32 Screw	

## Electrical Characteristics

Symbol	Parameter	Typ.	Max.	Unit	Test Conditions	Note
$V_F$	Forward Voltage	1.6 1.9	1.8 2.4	V	$I_F = 8\text{ A}$ $T_J = 25^\circ\text{C}$ $I_F = 8\text{ A}$ $T_J = 175^\circ\text{C}$	
$I_R$	Reverse Current	10 20	50 200	$\mu\text{A}$	$V_R = 600\text{ V}$ $T_J = 25^\circ\text{C}$ $V_R = 600\text{ V}$ $T_J = 175^\circ\text{C}$	
$Q_C$	Total Capacitive Charge	21		nC	$V_R = 600\text{ V}$ , $I_F = 8\text{ A}$ $di/dt = 500\text{ A}/\mu\text{s}$ $T_J = 25^\circ\text{C}$	
C	Total Capacitance	441 39 33		pF	$V_R = 0\text{ V}$ , $T_J = 25^\circ\text{C}$ , $f = 1\text{ MHz}$ $V_R = 200\text{ V}$ , $T_J = 25^\circ\text{C}$ , $f = 1\text{ MHz}$ $V_R = 400\text{ V}$ , $T_J = 25^\circ\text{C}$ , $f = 1\text{ MHz}$	

Note:

1. This is a majority carrier diode, so there is no reverse recovery charge.

## Thermal Characteristics

Symbol	Parameter	Typ.	Unit
$R_{\theta JC}$	Thermal Resistance from Junction to Case	1.5	$^\circ\text{C}/\text{W}$

## Typical Performance

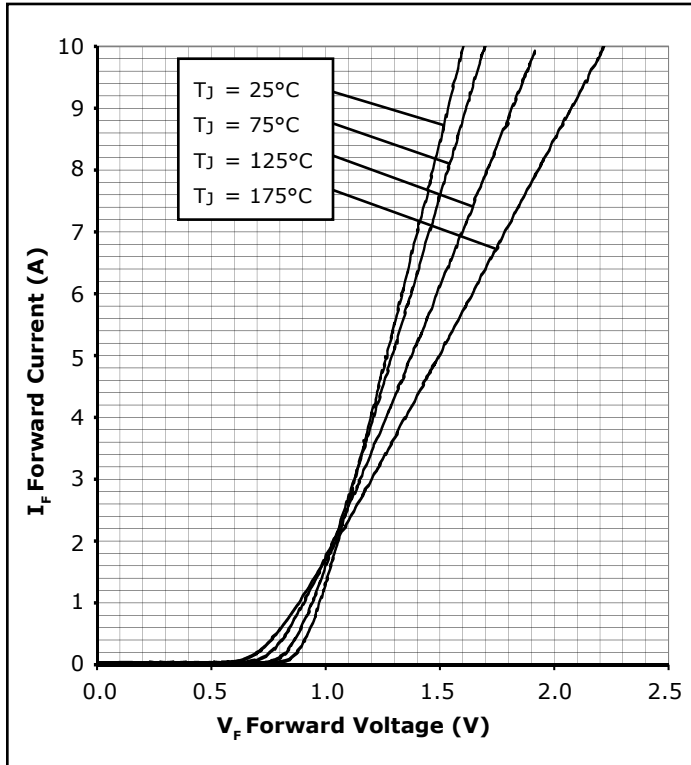

Figure 1. Forward Characteristics

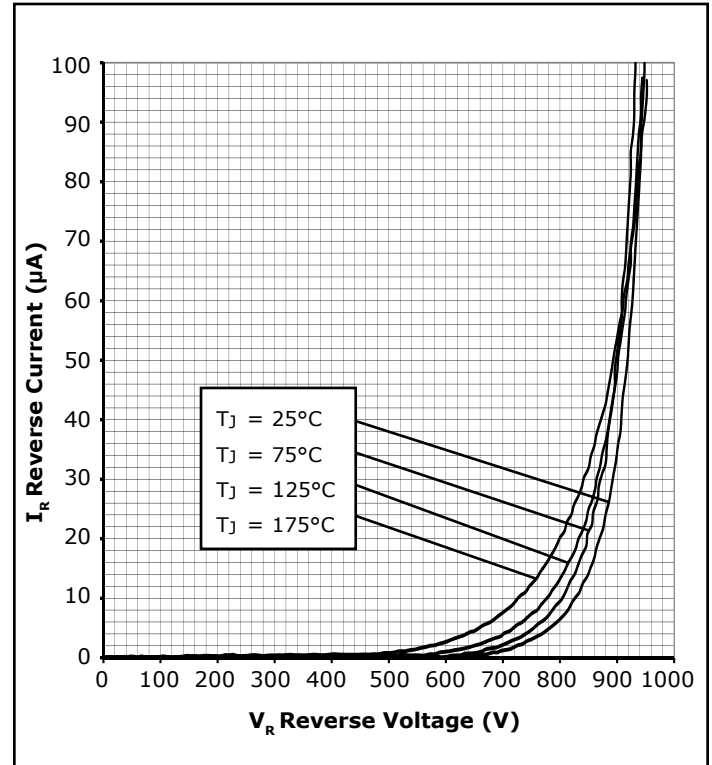

Figure 2. Reverse Characteristics

## Typical Performance

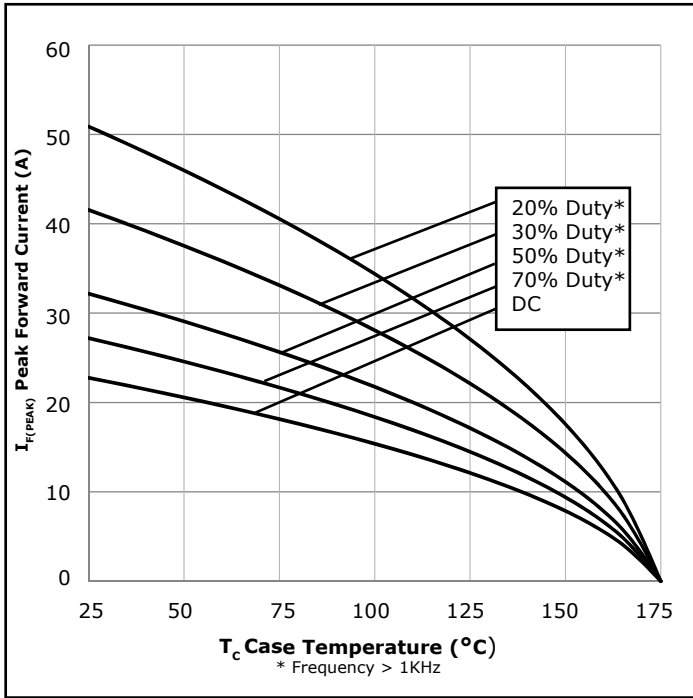

Figure 3. Current Derating

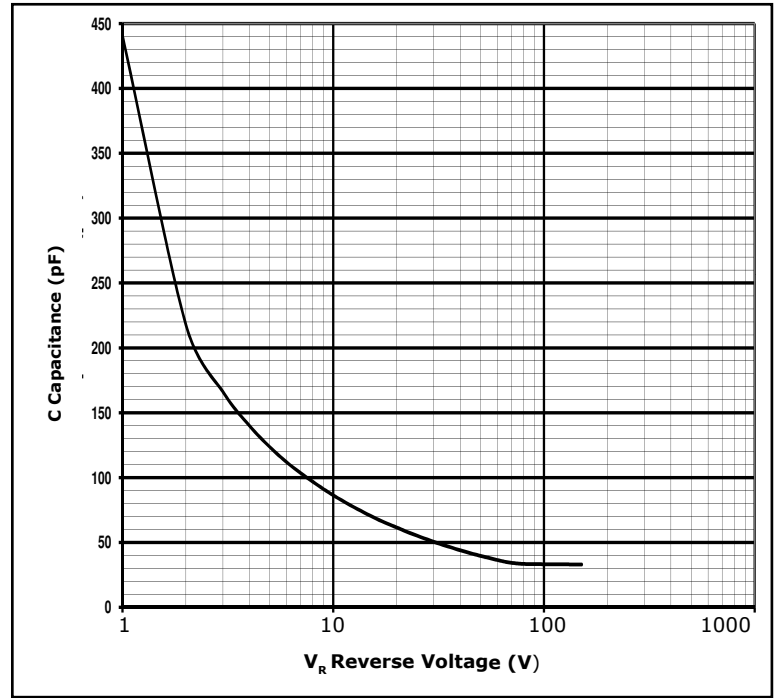

Figure 4. Capacitance vs. Reverse Voltage

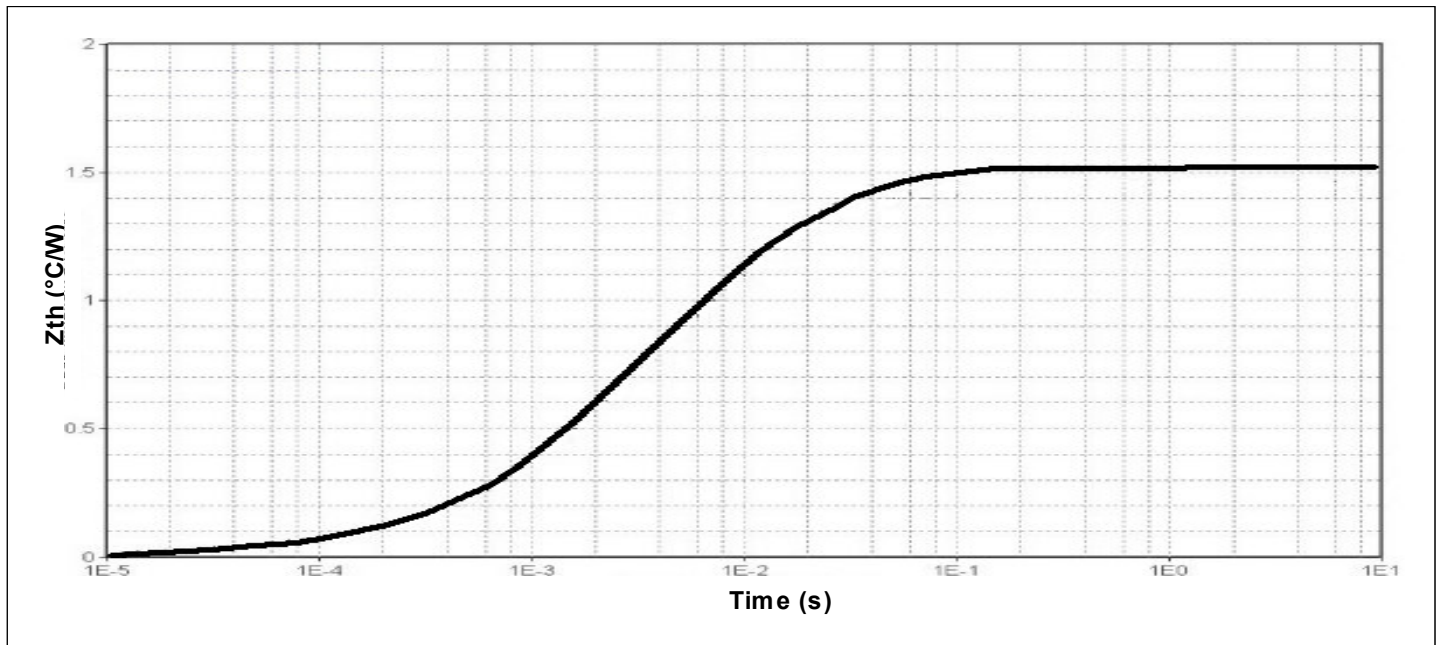

Figure 5. Transient Thermal Impedance

## Typical Performance

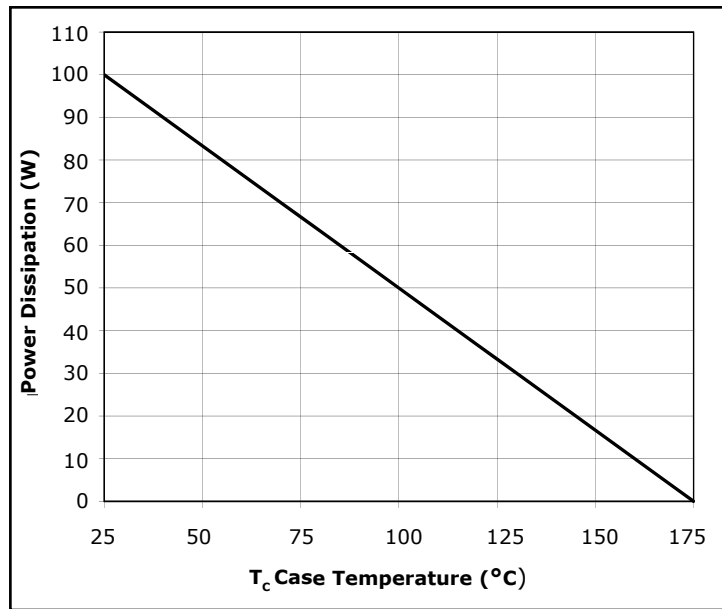
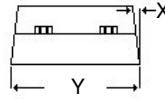
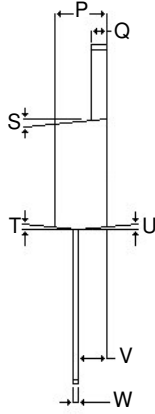
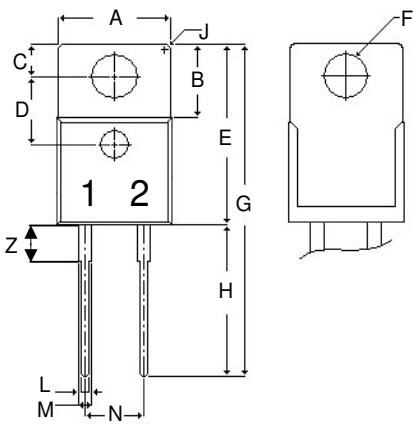

Figure 6. Power Derating

Package TO-220-2



POS	Inches		Millimeters	
	Min	Max	Min	Max
A	.381	.410	9.677	10.414
B	.235	.255	5.969	6.477
C	.100	.120	2.540	3.048
D	.223	.337	5.664	8.560
E	.590	.615	14.986	15.621
F	.143	.153	3.632	3.886
G	1.105	1.147	28.067	29.134
H	.500	.550	12.700	13.970
J	R 0.197		R 0.197	
L	.025	.036	.635	.914
M	.045	.055	1.143	1.397
N	.195	.205	4.953	5.207
P	.165	.185	4.191	4.699
Q	.048	.054	1.219	1.372
S	3°	6°	3°	6°
T	3°	6°	3°	6°
U	3°	6°	3°	6°
V	.094	.110	2.388	2.794
W	.014	.025	.356	.635
X	3°	5.5°	3°	5.5°
Y	.385	.410	9.779	10.414
Z	.130	.150	3.302	3.810

NOTE:

1. Dimension L, M, W apply for Solder Dip Finish

## Recommended Solder Pad Layout

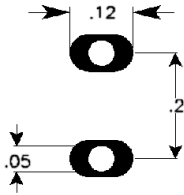

TO-220-2

Part Number	Package	Marking
C3D08060A	TO-220-2	C3D08060

## Diode Model

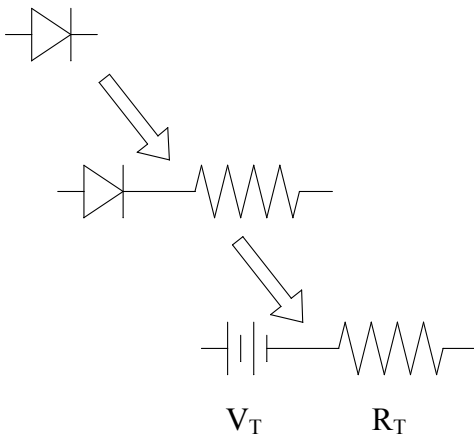

$$V_{f_T} = V_T + I_f * R_T$$

$$V_T = 0.93 + (T_j * -9.3 * 10^{-4})$$

$$R_T = 0.058 + (T_j * 5.7 * 10^{-4})$$

**Note:**  $T_j$  = Diode Junction Temperature In Degrees Celcius

"The levels of environmentally sensitive, persistent biologically toxic (PBT), persistent organic pollutants (POP), or otherwise restricted materials in this product are below the maximum concentration values (also referred to as the threshold limits) permitted for such substances, or are used in an exempted application, in accordance with EU Directive 2002/95/EC on the restriction of the use of certain hazardous substances in electrical and electronic equipment (RoHS), as amended through April 21, 2006.

This product has not been designed or tested for use in, and is not intended for use in, applications implanted into the human body nor in applications in which failure of the product could lead to death, personal injury or property damage, including but not limited to equipment used in the operation of nuclear facilities, life-support machines, cardiac defibrillators or similar emergency medical equipment, aircraft navigation or communication or control systems, air traffic control systems, or weapons systems.

Copyright © 2009 Cree, Inc. All rights reserved. The information in this document is subject to change without notice. Cree and the Cree logo are registered trademarks and Z-Rec is a trademark of Cree, Inc.

Cree, Inc.  
4600 Silicon Drive  
Durham, NC 27703  
USA Tel: +1.919.313.5300  
Fax: +1.919.313.5451  
www.cree.com/power