

SuperFlux LEDs

Introduction

This revolutionary package design allows the lighting designer to reduce the number of LEDs required and provide a more uniform and unique illuminated appearance than with other LED solutions. This is possible through the efficient optical package design and high-current capabilities.

The low profile package can be easily coupled with reflectors or lenses to efficiently distribute light and provide the desired lit appearance. This product family employs the world's brightest red, red-orange, amber, blue, cyan, and green LED materials, which allow designers to match the color of many lighting applications like vehicle signal lamps, specialty lighting, and electronic signs.

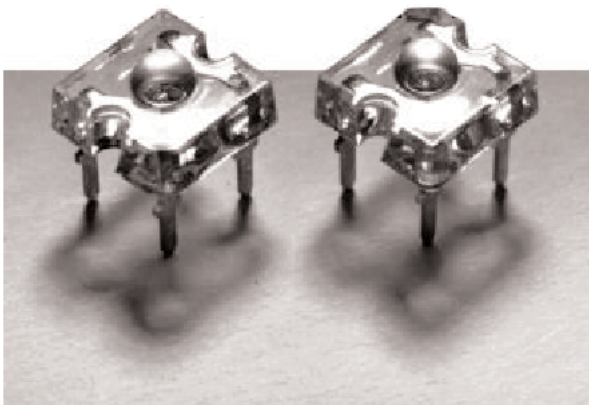

HPWA-MH00
 HPWT-MH00
 HPWA-DH00
 HPWT-DH00
 HPWT-RD00
 HPWT-BH00
 HPWT-MD00
 HPWT-RL00
 HPWT-DD00
 HPWT-ML00
 HPWT-BD00
 HPWT-DL00
 HPWT-RH00
 HPWT-BL00
 HPWN-MB00
 HPWN-MC00
 HPWN-MG00

Key Benefits

- ◆ Rugged Lighting Products
- ◆ Electricity Savings
- ◆ Maintenance Savings

Features

- ◆ High Luminance
- ◆ Uniform Color
- ◆ Low Power Consumption
- ◆ Low Thermal Resistance
- ◆ Low Profile
- ◆ Meets SAE/ECE/JIS Automotive Color Requirements
- ◆ Packaged in tubes for use with automatic insertion equipment

Typical Applications

- ◆ Automotive Exterior Lighting
- ◆ Electronic Signs and Signals
- ◆ Specialty Lighting

Outline Drawings

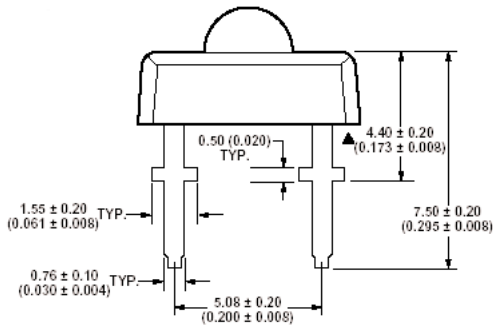
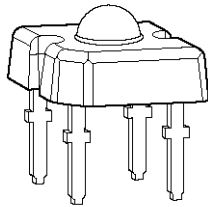
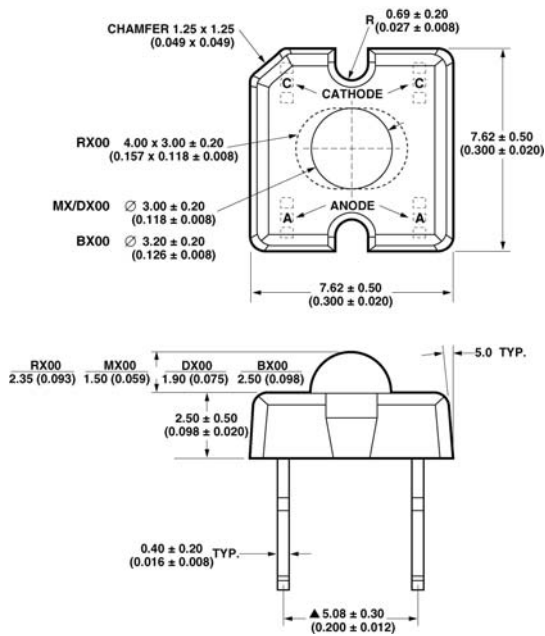

Selection Guide

Table 1

Device Type	LED Color	Total Flux Φ_V (LM) @ 70 mA ^[1] (HPWA, HPWT) 50 mA (HPWN)		Total Included Angle θ_{90V} (Degrees) ^[2]
		Typ.	Typ.	
HPWA-MH00	AS AlInGaP Red-Orange	1.5		95
HPWA-DH00				75
HPWT-RD00				44 X 88
HPWT-MD00	TS AlInGaP Red	3.5		100
HPWT-DD00				70
HPWT-BD00				50
HPWT-RH00				44 X 88
HPWT-MH00	TS AlInGaP Red-Orange	4.2		100
HPWT-DH00				70
HPWT-BH00				50
HPWT-RL00				44 X 88
HPWT-ML00	TS AlInGaP Amber	1.7		100
HPWT-DL00				70
HPWT-BL00				50
HPWN-MB00	InGaN Blue	2.0		110
HPWN-MC00	InGaN Cyan	5.0		110
HPWN-MG00	InGaN Green	4.5		110

Notes:

- Φ_V is the total luminous flux output as measured with an integrating sphere after the device has stabilized. ($R_{\theta J-A} = 200^\circ\text{C/W}$, $T_A = 25^\circ\text{C}$)
- $\theta_{0.90V}$ is the included angle at which 90% of the total luminous flux is captured.

Absolute Maximum Ratings at $T_A = 25^\circ\text{C}$

Table 2

Parameter	HPWA	HPWT	HPWN	Units
DC Forward Current ^[1]	70	70	50	mA
Power Dissipation	187	221	233	mW
Reverse Voltage ($I_R = 100 \mu\text{A}$)	10	10	0.55	V
Operating Temperature Range	-40 to +100			$^\circ\text{C}$
Storage Temperature Range	-55 to +100			$^\circ\text{C}$
High Temperature Chamber	125 $^\circ\text{C}$, 2 Hours			
LED Junction Temperature	125 $^\circ\text{C}$			
Solder Conditions ^[2]				
Preheat Temperature	85 +/- 15 $^\circ\text{C}$, 20 sec (Max 30 sec)			
Solder Temperature	235 +/- 5 $^\circ\text{C}$, 2.5 +/- 0.5 sec [1.5mm (0.06 in) below seating plane]			

Optical Characteristics at $T_A = 25^\circ\text{C}$, $I_F = 70\text{ mA}$ (HPWA, HPWT), $I_F = 50\text{ mA}$ (HPWN), $R_{\theta\text{J-A}} = 200^\circ\text{C/W}$

Table 3

Device Type	Peak Wavelength	Dominant Wavelength	Total Included Angle $\theta_{0.90\text{V}}$	Luminous Intensity/ Total Flux	Viewing Angle $\theta^{1/2}$
	λ_{peak} (nm) Typ.	λ_{dom} (nm) ¹⁾ Typ.	(Degrees) ²⁾ Typ.	$I_v(\text{cd})/\Phi_v(\text{lm})$ Typ.	(Degrees) Typ.
HPWA-MH00	624	618	95	0.6	90
HPWA-DH00			75	0.9	60
HPWT-RD00			44 X 88	1.25	25 x 68
HPWT-MD00	640	630	100	0.6	70
HPWT-DD00			70	1.5	40
HPWT-BD00			50	2.0	30
HPWT-RH00			44 X 88	1.25	25 x 68
HPWT-MH00	626	620	100	0.6	70
HPWT-DH00			70	1.5	40
HPWT-BH00			50	2.0	30
HPWT-RL00			44 X 88	1.25	25 x 68
HPWT-ML00	596	594	100	0.6	70
HPWT-DL00			70	1.5	40
HPWT-BL00			50	2.0	30
HPWN-MB00	460	470	110	0.9	90
HPWN-MC00	503	505	110	0.9	90
HPWN-MG00	520	525	110	0.9	90

Notes:

- The dominant wavelength is derived from the CIE Chromaticity Diagram and represents the perceived color of the device.
- $\theta_{0.90\text{V}}$ is the included angle at which 90% of the total luminous flux is captured.

Electrical Characteristics at $T_A=25^\circ\text{C}$

Table 4

Device Type	Forward Voltage V_F (Volts) @ $I_F = 70\text{ mA}$ (HPWA, HPWT) $I_F = 50\text{ mA}$ (HPWN)			Reverse Breakdown V_R (Volts) ¹⁾ @ $I_R = 100$ μA		Capacitance C (pF) $V_F = 0$, F = 1MHz.	Thermal Resistance $R_{\theta\text{J-PIN}}$ ($^\circ\text{C/W}$)	Speed of Response τ_s (ns) ²⁾
	Min	Typ	Max	Min	Typ.	Typ.	Typ.	Typ.
HPWA-xH00	1.83	2.1	2.67	10	20	40	155	20
HPWT-xD00	2.19	2.5	3.03	10	20	40	125	20
HPWT-xH00	2.19	2.5	3.03	10	20	40	125	20
HPWT-xL00	2.19	2.6	3.15	10	20	40	125	20
HPWN-xB00	3.00	3.8	4.60	0.55	0.65	1900	130	20
HPWN-xC00	3.00	3.8	4.60	0.55	0.65	1900	130	20
HPWN-xG00	3.00	3.9	4.60	0.55	0.65	1900	130	20

Notes:

- Operation in reverse bias is not recommended.
- τ_s is the time constant, e^{-t/τ_s} .

Part Number Selection

Red

Part Number	Description	Viewing Angle $\theta^{1/2}$ (Degrees)	Min. Flux ⁽¹⁾ Φ_v (lm)	Max Flux Φ_v (lm)	Minimum Intensity (cd)	Maximum Intensity (cd)
HPWT-RD00-00000		25 X 68	1.5		1.9	
HPWT-RD00-D4000		25 X 68	2.0	4.8	2.5	6.0
HPWT-RD00-E4000		25 X 68	2.5	6.1	3.1	7.6
HPWT-RD00-F4000		25 X 68	3.0	7.3	3.8	9.1
HPWT-BD00-00000		30	1.5		3.0	
HPWT-BD00-D4000		30	2.0	4.8	4.0	9.6
HPWT-BD00-E4000		30	2.5	6.1	5.0	12.2
HPWT-BD00-F4000	SuperFlux	30	3.0	7.3	6.0	14.6
HPWT-DD00-00000	LED	40	1.5		2.3	
HPWT-DD00-D4000		40	2.0	4.8	3.0	7.2
HPWT-DD00-E4000		40	2.5	6.1	3.8	9.2
HPWT-DD00-F4000		40	3.0	7.3	4.5	11.0
HPWT-MD00-00000		70	1.5		0.9	
HPWT-MD00-D4000		70	2.0	4.8	1.2	2.9
HPWT-MD00-E4000		70	2.5	6.1	1.5	3.7
HPWT-MD00-F4000		70	3.0	7.3	1.8	4.4

Note:

1. Φ_v is the total luminous flux output as measured with an integrating sphere after the device has stabilized.

Red-Orange

Part Number	Description	Viewing Angle $\theta^{1/2}$ (Degrees)	Min. Flux Φ_v (lm)	Max Flux Φ_v (lm)	Minimum Intensity (cd)	Maximum Intensity (cd)
HPWT-RH00-00000		25 X 68	1.5		1.9	
HPWT-RH00-D4000		25 X 68	2.0	4.8	2.5	6.0
HPWT-RH00-E4000		25 X 68	2.5	6.1	3.1	7.6
HPWT-RH00-F4000		25 X 68	3.0	7.3	3.8	9.1
HPWT-RH00-G4000		25 X 68	3.5	9.7	4.4	12.1
HPWT-RH00-H4000		25 X 68	4.0	12.0	5.0	15.0
HPWT-BH00-00000		30	1.5		3.0	
HPWT-BH00-D4000		30	2.0	4.8	4.0	9.6
HPWT-BH00-E4000		30	2.5	6.1	5.0	12.2
HPWT-BH00-F4000		30	3.0	7.3	6.0	14.6
HPWT-BH00-G4000		30	3.5	9.7	7.0	19.4
HPWT-BH00-H4000		30	4.0	12.0	8.0	24.0
HPWT-DH00-00000		40	1.5		2.3	
HPWT-DH00-D4000	SuperFlux	40	2.0	4.8	3.0	7.2
HPWT-DH00-E4000	LED	40	2.5	6.1	3.8	9.2
HPWT-DH00-F4000		40	3.0	7.3	4.5	11.0
HPWT-DH00-G4000		40	3.5	9.7	5.3	14.6
HPWT-DH00-H4000		40	4.0	12.0	6.0	18.0
HPWT-MH00-00000		70	1.5		0.9	
HPWT-MH00-D4000		70	2.0	4.8	1.2	2.9
HPWT-MH00-E4000		70	2.5	6.1	1.5	3.7
HPWT-MH00-F4000		70	3.0	7.3	1.8	4.4
HPWT-MH00-G4000		70	3.5	9.7	2.1	5.8
HPWT-MH00-H4000		70	4.0	12.0	2.4	7.2
HPWA-MH00-B4000		90	1.0	3.6	0.6	2.2
HPWA-DH00-B4000		40	1.0	3.6	1.5	5.4
HPWA-MH00-C4000		90	1.5	4.2	0.9	2.5
HPWA-DH00-C4000		40	1.5	4.2	2.3	6.3

Amber

Part Number	Description	Viewing Angle $\theta^{1/2}$ (Degrees)	Min. Flux Φ_v (lm)	Max Flux Φ_v (lm)	Minimum Intensity (cd)	Maximum Intensity (cd)
HPWT-RL00-00000		25 X 68	1.0		1.3	
HPWT-RL00-C4000		25 X 68	1.5	4.2	1.9	5.3
HPWT-RL00-D4000		25 X 68	2.0	4.8	2.5	6.0
HPWT-BL00-00000		30	1.0		2.0	
HPWT-BL00-C4000		30	1.5	4.2	3.0	8.4
HPWT-BL00-D4000	SuperFlux	30	2.0	4.8	4.0	9.6
HPWT-DL00-00000	LED	40	1.0		1.5	
HPWT-DL00-C4000		40	1.5	4.2	2.3	6.3
HPWT-DL00-D4000		40	2.0	4.8	3.0	7.2
HPWT-ML00-00000		70	1.0		0.6	
HPWT-ML00-C4000		70	1.5	4.2	0.9	2.5
HPWT-ML00-D4000		70	2.0	4.8	1.2	2.9

Green

Part Number	Description	Viewing Angle $\theta^{1/2}$ (Degrees)	Min. Flux Φ_v (lm)	Max Flux Φ_v (lm)	Minimum Intensity (cd)	Maximum Intensity (cd)
HPWN-MG00-00000	SuperFlux LED	90	3.0		2.7	

Cyan

Part Number	Description	Viewing Angle $\theta^{1/2}$ (Degrees)	Min. Flux Φ_v (lm)	Max Flux Φ_v (lm)	Minimum Intensity (cd)	Maximum Intensity (cd)
HPWN-MC00-00000	SuperFlux LED	90	3.0		2.7	

Blue

Part Number	Description	Viewing Angle $\theta^{1/2}$ (Degrees)	Min. Flux Φ_v (lm)	Max Flux Φ_v (lm)	Minimum Intensity (cd)	Maximum Intensity (cd)
HPWN-MB00-00000	SuperFlux LED	90	1.0		0.9	

Figures

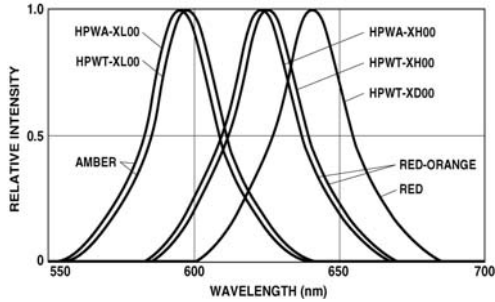

Figure 1a. Relative Intensity vs. Wavelength

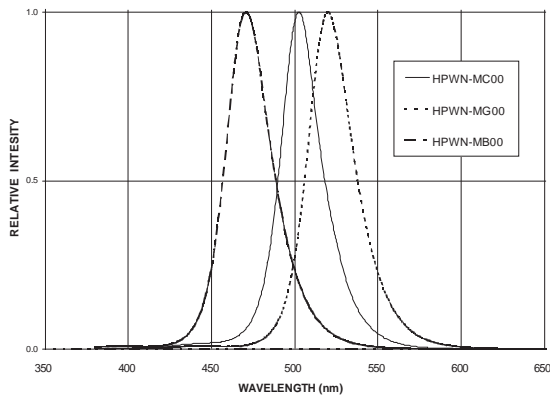

Figure 1b. Relative Intensity vs. Wavelength (HPWN)

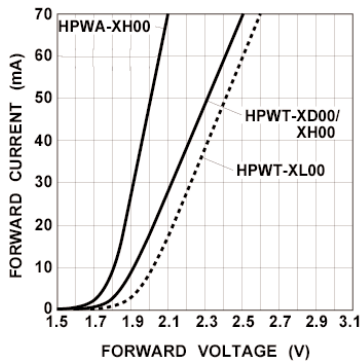

Figure 2a. Forward Current vs. Forward Voltage

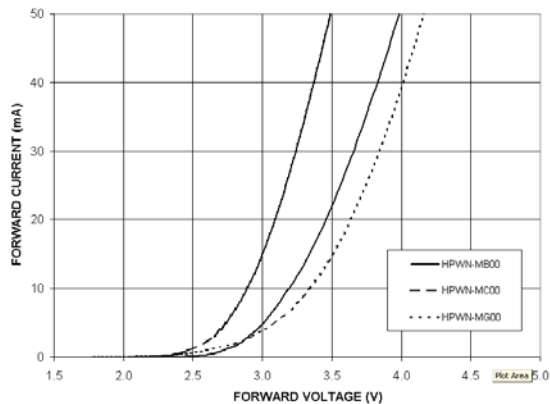

Figure 2b. Forward Current vs. Forward Voltage

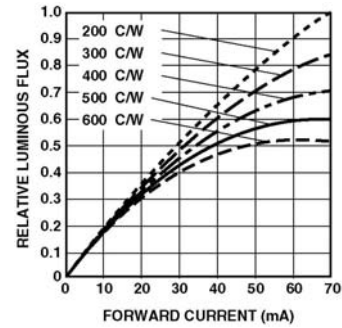

Figure 3. HPWA/HPWT-xx00 Relative Luminous Flux vs. Forward Current.

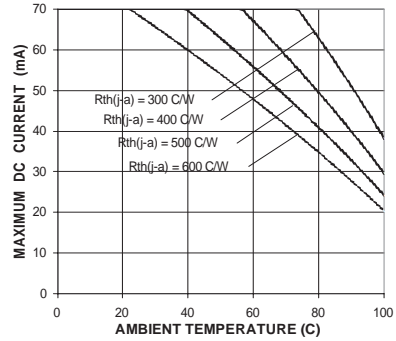

Figure 4a. HPWA-xx00 Maximum DC Forward Current vs. Ambient Temperature.

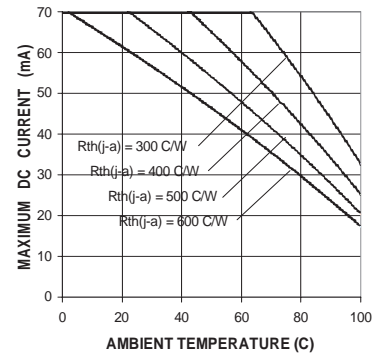

Figure 4b. HPWT-xx00 Maximum DC Forward Current vs. Ambient Temperature.

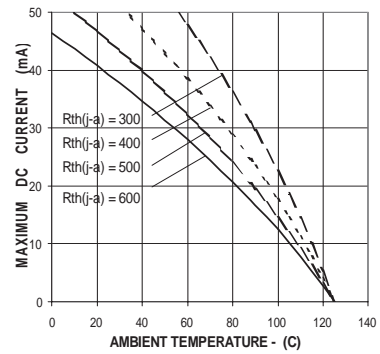

Figure 4c. HPWN-xx00 Maximum DC Forward Current vs. Ambient Temperature.

Note:

1.24mm² of Cu pad per emitter at cathode lead is recommended for lowest thermal resistance.

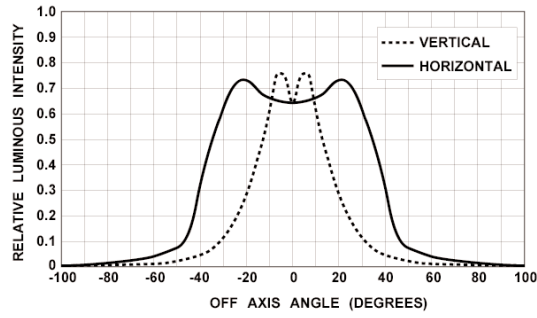

Figure 5a. HPWT-Rx00 Relative Luminous Intensity vs. Off Axis Angle.

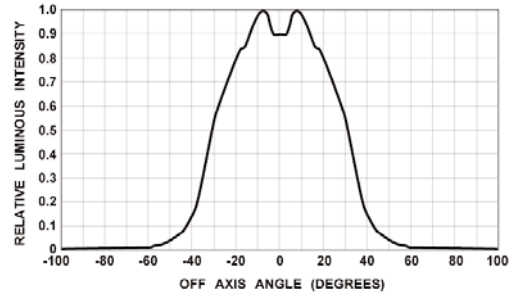

Figure 5e. HPWA(T)-Dx00 Relative Luminous Intensity vs. Off Axis Angle.

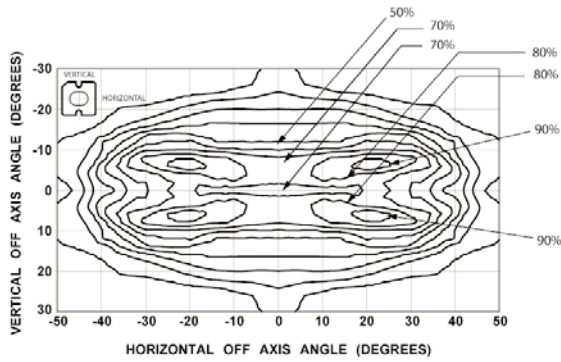

Figure 5b. HPWT-Rx00 Relative Luminous Intensity vs. Off Axis Angle. Iso-Intensity Contour Plot.

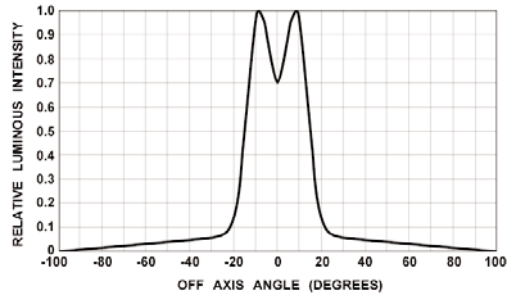

Figure 5f. HPWT-Bx00 Relative Luminous Intensity vs. Off Axis Angle.

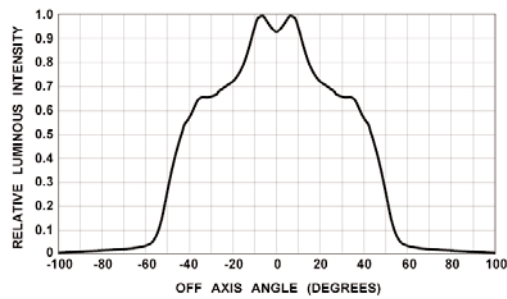

Figure 5c. HPWA-Mx00 Relative Luminous Intensity vs. Off Axis Angle.

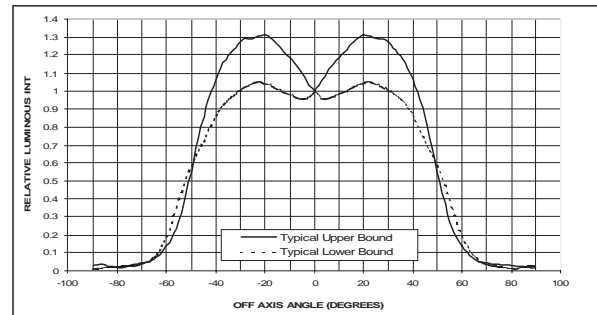

Figure 5g. HPWN-Mx00 Relative Luminous Intensity vs. Off Axis Angle

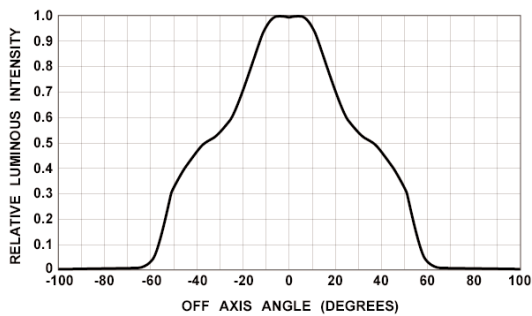

Figure 5d. HPWT-Mx00 Relative Luminous Intensity vs. Off Axis Angle.

Company Information

Lumileds is a world-class supplier of Light Emitting Diodes (LEDs) producing billions of LEDs annually. Lumileds is a fully integrated supplier, producing core LED material in all three base colors (Red, Green, Blue) and White. Lumileds has R&D development centers in San Jose, California and Best, The Netherlands. Production capabilities in San Jose, California and Malaysia.

Lumileds is pioneering the high-flux LED technology and bridging the gap between solid state LED technology and the lighting world. Lumileds is absolutely dedicated to bringing the best and brightest LED technology to enable new applications and markets in the lighting world.

Lumileds may make process or materials changes affecting the performance or other characteristics of our products. These products supplied after such changes will continue to meet published specifications, but may not be identical to products supplied as samples or under prior orders.



WWW.LUXEON.COM
WWW.LUMILEDSFUTURE.COM

FOR TECHNICAL ASSISTANCE OR THE
LOCATION OF YOUR NEAREST SALES
OFFICE CONTACT ANY OF THE
FOLLOWING:

NORTH AMERICA:
+ 1 888 589 3662 OR
ASKLUXEON@FUTUREELECTRONICS.COM

EUROPE:
OO 800 443 88 873 OR
LUXEON.EUROPE@FUTUREELECTRONICS.COM

ASIA:
800 5864 5337 OR
LUMILEDS.ASIA@FUTUREELECTRONICS.COM