

power light source

Luxeon III Emitter

Introduction

Luxeon® III is a revolutionary, energy efficient and ultra compact new light source, combining the lifetime and reliability advantages of Light Emitting Diodes with the brightness of conventional lighting.

Luxeon III is rated for up to 1400mA operation, delivering increased lumens per package.

Luxeon Emitters give you total design freedom and unmatched brightness, creating a new world of light.

Luxeon Emitters can be purchased in reels for high volume assembly. For more information, consult your local Lumileds representative.

For high volume applications, custom Luxeon power light source designs are available upon request, to meet your specific needs.



Features

- ♦ Highest flux per LED family in the world
- ♦ Very long operating life (up to 100k hours)
- ♦ Available in 5500K white, green, blue, royal blue, cyan, red, red-orange, and amber
- ♦ Lambertian and side emitting radiation patterns
- ♦ More energy efficient than incandescent and most halogen lamps
- ♦ Low voltage DC operated
- ♦ Cool beam, safe to the touch
- ♦ Instant light (less than 100 ns)
- ♦ Fully dimmable
- ♦ No UV
- ♦ Superior ESD protection

Typical Applications

- ♦ Reading lights (car, bus, aircraft)
- ♦ Portable (flashlight, bicycle)
- ♦ Mini-accent/Uplighters/Downlighters/Orientation
- ♦ Fiber optic alternative/Decorative/Entertainment
- ♦ Bollards/Security/Garden
- ♦ Cove/Undershelf/Task
- ♦ Automotive rear combination lamps
- ♦ Traffic signaling/Beacons/ Rail crossing and Wayside
- ♦ Indoor/Outdoor Commercial and Residential Architectural
- ♦ Edge-lit signs (Exit, point of sale)
- ♦ LCD Backlights/Light Guides

Mechanical Dimensions

Lambertian

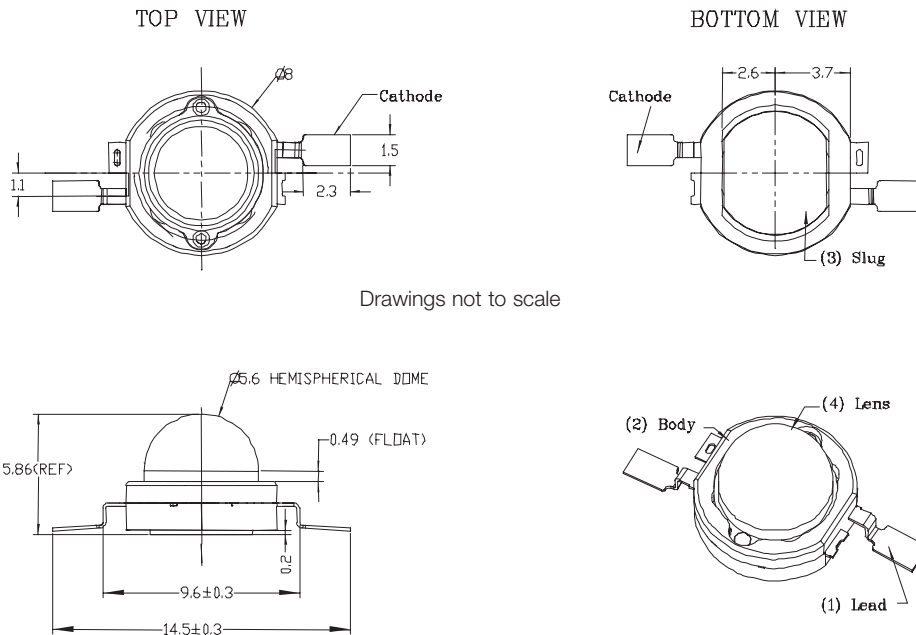

Drawings not to scale

Notes:

1. The anode side of the device is denoted by a hole in the lead frame. Electrical insulation between the case and the board is required—slug of device is not electrically neutral. Do not electrically connect either the anode or cathode to the slug.
2. All dimensions are in millimeters.
3. All dimensions without tolerances are for reference only.

Side Emitting

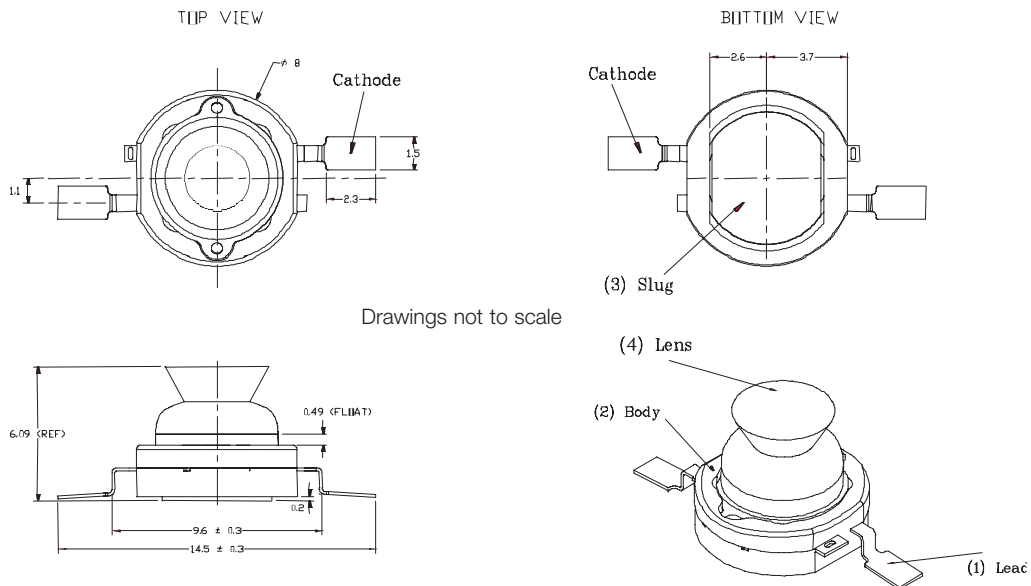

Drawings not to scale

Notes:

1. The anode side of the device is denoted by a hole in the lead frame. Electrical insulation between the case and the board is required—slug of device is not electrically neutral. Do not electrically connect either the anode or cathode to the slug.
2. Caution must be used in handling this device to avoid damage to the lens surfaces that will reduce optical efficiency.
3. All dimensions are in millimeters.
4. All dimensions without tolerances are for reference only.

Flux Characteristics at 700mA, Junction Temperature, $T_J = 25^\circ\text{C}$

Table 1.

Color	Luxeon Emitter	Minimum Luminous Flux (lm) or Radiometric Power (mW) $\Phi_V^{[1,2]}$	Typical Luminous Flux (lm) or Radiometric Power (mW) $\Phi_V^{[2]}$	Radiation Pattern
White	LXHL-PW09	60.0	65	Lambertian
Green	LXHL-PM09	51.7	64	
Cyan	LXHL-PE09	51.7	64	
Blue ^[3]	LXHL-PB09	13.9	23	
Royal Blue ^[4]	LXHL-PR09	275 mW	340 mW	
White	LXHL-DW09	51.7	58	Side Emitting
Green	LXHL-DM09	51.7	58	
Blue ^[3]	LXHL-DB09	13.9	21	

Flux Characteristics at 1000mA, Junction Temperature, $T_J = 25^\circ\text{C}$

Table 2.

Color	Luxeon Emitter	Typical Luminous Flux (lm) or Radiometric Power (mW) $\Phi_V^{[1,2]}$ 1000 mA	Radiation Pattern
White	LXHL-PW09	80	Lambertian
Green	LXHL-PM09	80	
Cyan	LXHL-PE09	80	
Blue ^[3]	LXHL-PB09	30	
Royal Blue ^[4]	LXHL-PR09	450 mW	
White	LXHL-DW09	70	Side Emitting
Green	LXHL-DM09	70	
Blue ^[3]	LXHL-DB09	27	

Notes for Tables 1 & 2:

1. Minimum luminous flux or radiometric power performance guaranteed within published operating conditions. Lumileds maintains a tolerance of $\pm 10\%$ on flux and power measurements.
2. Luxeon types with even higher luminous flux levels will become available in the future. Please consult your Lumileds Authorized Distributor or Lumileds sales representative for more information.
3. Typical flux value for 470nm devices. Due to the CIE eye response curve in the short blue wavelength range, the minimum luminous flux will vary over the Lumileds blue color range. Luminous flux will vary from a typical of 17lm for the 460-465nm bin to a typical of 30lm for the 475-480 nm bin due to this effect. Although the luminous power efficiency is lower in the short blue wavelength range, radiometric power efficiency increases as wavelength decreases. For more information, consult the Luxeon Design Guide, available upon request.
4. Royal Blue product is binned by radiometric power and peak wavelength rather than photometric lumens and dominant wavelength.

Flux Characteristics at 1400mA, Junction Temperature, $T_J = 25^\circ\text{C}$

Table 3.

Color	Luxeon Emitter	Minimum Luminous Flux (lm) $F_V^{[1,2]}$	Typical Luminous Flux (lm) $F_V^{[2]}$	Radiation Pattern
Red	LXHL-PD09	90	140	Lambertian
Red-Orange	LXHL-PH09	120	190	
Amber	LXHL-PL09	70	110	
Red	LXHL-DD09	90	125	Side Emitting
Red-Orange	LXHL-DH09	120	170	
Amber	LXHL-DL09	70	100	

Notes for Table 3:

1. Minimum luminous flux performance guaranteed within published operating conditions. Lumileds maintains a tolerance of $\pm 10\%$ on flux measurements.
2. Luxeon types with even higher luminous flux levels will become available in the future. Please consult your Lumileds Authorized Distributor or Lumileds sales representative for more information.

Optical Characteristics at 700mA, Junction Temperature, $T_J = 25^\circ\text{C}$

Table 4.

Radiation Pattern	Color	Dominant Wavelength ^[1] λ_D , Peak Wavelength ^[2] λ_P , or Color Temperature ^[3] CCT			Spectral Half-width ^[4] (nm) $\Delta\lambda_{1/2}$	Temperature Coefficient of Dominant Wavelength (nm/ $^\circ\text{C}$) $\Delta\lambda_D / \Delta T_J$	Total Included Angle ^[5] (degrees) $\theta_{0.90V}$	Viewing Angle ^[6] (degrees) $2\theta_{1/2}$
		Min.	Typ.	Max.				
Lambertian	White	4500K	5500K	10000K	—	—		
	Green	520nm	530nm	550nm	35	0.04	160	140
	Cyan	490nm	505nm	520nm	30	0.04	160	140
	Blue	460nm	470nm	490nm	25	0.04	160	140
	Royal Blue ^[2]	440nm	455nm	460nm	20	0.04	160	140

Optical Characteristics at 700mA, Junction Temperature, $T_J = 25^\circ\text{C}$ Continued

Table 5.

Radiation Pattern	Color	Dominant Wavelength ^[1] λ_D , or Color Temperature ^[3] CCT			Spectral Half-width ^[4] (nm) Cum Φ_{45°	Temperature Coefficient of Dominant Wavelength (nm/ $^\circ\text{C}$) $\Delta\lambda_D / \Delta T_J$	Typical Total Flux Percent within first 45° ^[7] Cum Φ_{45°	Typical Angle of Peak Intensity ^[8] θ_{Peak}
		Min.	Typ.	Max.				
Side Emitting	White	4500K	5500K	10000K	—	—	<15%	$75^\circ - 85^\circ$
	Green	520nm	530nm	550nm	35	0.04	<15%	$75^\circ - 85^\circ$
	Blue	460nm	470nm	490nm	20	0.04	<15%	$75^\circ - 85^\circ$

Notes: (for Tables 4 & 5)

1. Dominant wavelength is derived from the CIE 1931 Chromaticity diagram and represents the perceived color. Lumileds maintains a tolerance of $\pm 0.5\text{nm}$ for dominant wavelength measurements.
2. Royal Blue product is binned by radiometric power and peak wavelength rather than photometric lumens and dominant wavelength. Lumileds maintains a tolerance of $\pm 2\text{nm}$ for peak wavelength measurements.
3. CRI (Color Rendering Index) for White product types is 70. CRI for Warm White product type is 90 with typical R_9 value of 70. CCT $\pm 5\%$ tester tolerance.
4. Spectral width at $1/2$ of the peak intensity.
5. Total angle at which 90% of total luminous flux is captured.
6. $\theta_{1/2}$ is the off axis angle from lamp centerline where the luminous intensity is $1/2$ of the peak value.
7. Cumulative flux percent within $\pm 45^\circ$ from optical axis.
8. Off axis angle from lamp centerline where the luminous intensity reaches the peak value.
9. All white, green, cyan, blue and royal blue products built with Indium Gallium Nitride (InGaN).
10. Blue and Royal Blue power light sources represented here are IEC825 Class 2 for eye safety.

Optical Characteristics at 1400mA, Junction Temperature, $T_J = 25^\circ\text{C}$

Table 6.

Radiation Pattern	Color	Dominant Wavelength ^[1]			Spectral Half-width ^[2] (nm) $\Delta\lambda_{1/2}$	Temperature Coefficient of Dominant Wavelength (nm/ $^\circ\text{C}$) $\Delta\lambda_p / \Delta T_J$	Total Included Angle ^[3] (degrees) $\theta_{0.90V}$	Viewing Angle ^[4] (degrees) $2\theta_{1/2}$
		Min.	Typ.	Max.				
Lambertian	Red	620.5nm	627nm	645nm	20	0.05	170	130
	Red-Orange	613.5nm	617nm	620.5nm	18	0.06	170	130
	Amber	584.5nm	590nm	597nm	17	0.09	170	130

Optical Characteristics at 1400mA, Junction Temperature, $T_J = 25^\circ\text{C}$, Continued

Table 7.

Radiation Pattern	Color	Dominant Wavelength ^[1]			Spectral Half-width ^[2] (nm) $\Delta\lambda_{1/2}$	Temperature Coefficient of Dominant Wavelength (nm/ $^\circ\text{C}$) $\Delta\lambda_p / \Delta T_J$	Typical Total Flux Percent within first 45° ^[5] Cum Φ_{45°	Typical Angle of Peak Intensity ^[6] θ_{Peak}
		Min.	Typ.	Max.				
Side Emitting	Red	620.5nm	627nm	645nm	20	0.05	<30%	75° - 85°
	Red-Orange	613.5nm	617nm	620.5nm	18	0.06	<30%	75° - 85°
	Amber	584.5nm	590nm	597nm	17	0.09	<30%	75° - 85°

Notes: (for Tables 6 & 7)

1. Dominant wavelength is derived from the CIE 1931 Chromaticity diagram and represents the perceived color. Lumileds maintains a tolerance of $\pm 0.5\text{nm}$ for dominant wavelength measurements.
2. Spectral width at $1/2$ of the peak intensity.
3. Total angle at which 90% of total luminous flux is captured.
4. $\theta_{1/2}$ is the off axis angle from lamp centerline where the luminous intensity is $1/2$ of the peak value.
5. Cumulative flux percent within $\pm 45^\circ$ from optical axis.
6. Off axis angle from lamp centerline where the luminous intensity reaches the peak value.
7. All red, red-orange and amber products built with Aluminum Indium Gallium Phosphide (AlInGaP).

Electrical Characteristics at 700mA, Junction Temperature, $T_J = 25^\circ\text{C}$

Table 8.

Color	Forward Voltage V_F ⁽¹⁾ (V)			Dynamic Resistance ⁽²⁾ (Ω) R_D	Temperature Coefficient of Forward Voltage ⁽³⁾ (mV/ $^\circ\text{C}$) $\Delta V_F / \Delta T_J$	Thermal Resistance, Junction to Case ($^\circ\text{C}/\text{W}$) $R_{\theta\text{J-C}}$
	Min.	Typ.	Max.			
White	3.03	3.70	4.47	0.8	-2.0	13
Green	3.03	3.70	4.47	0.8	-2.0	13
Cyan	3.03	3.70	4.47	0.8	-2.0	13
Blue	3.03	3.70	4.47	0.8	-2.0	13
Royal Blue	3.03	3.70	4.47	0.8	-2.0	13

Notes for Table 8:

1. Lumileds maintains a tolerance of $\pm 0.06\text{V}$ on forward voltage measurements.
2. Dynamic resistance is the inverse of the slope in linear forward voltage model for LEDs. See Figures 3a and 3b.
3. Measured between $25^\circ\text{C} \leq T_J \leq 110^\circ\text{C}$ at $I_F = 700\text{mA}$.

Electrical Characteristics at 1000mA, Junction Temperature, $T_J = 25^\circ\text{C}$

Table 9.

Color	Typical Forward Voltage V_F (V) ⁽¹⁾ 1000 mA
White	3.90
Green	3.90
Cyan	3.90
Blue	3.90
Royal Blue	3.90

Notes for Table 9:

1. Lumileds maintains a tolerance of $\pm 0.06\text{V}$ on forward voltage measurements.

Electrical Characteristics at 1400mA, Junction Temperature, $T_J = 25^\circ\text{C}$

Table 10.

Color	Forward Voltage V_F (V) ^[1]			Dynamic Resistance ^[2] (Ω) R_D	Temperature Coefficient of Forward Voltage ^[3] (mV/ $^\circ\text{C}$) $\Delta V_F / \Delta T_J$	Thermal Resistance, Junction to Case ($^\circ\text{C}/\text{W}$) $R_{\theta_{J-C}}$
	Min.	Typ.	Max.			
Red	2.31	2.95	3.51	0.7	-2.0	6
Red-Orange	2.31	2.95	3.51	0.7	-2.0	6
Amber	2.31	2.95	3.51	0.7	-2.0	6

Notes for Table 10:

1. Lumileds maintains a tolerance of $\pm 0.06\text{V}$ on forward voltage measurements.
2. Dynamic resistance is the inverse of the slope in linear forward voltage model for LEDs. See Figure 3.
3. Measured between $25^\circ\text{C} \leq T_J \leq 110^\circ\text{C}$ at $I_F = 1400\text{mA}$.

Absolute Maximum Ratings

Table 11.

Parameter	White/Green/ Cyan/Blue/ Royal Blue	Red/ Red-Orange/ Amber
DC Forward Current (mA) ^[1]	1000	1540
Peak Pulsed Forward Current (mA)	1000	2200
Average Forward Current (mA)	1000	1400
LED Junction Temperature ($^\circ\text{C}$)	135	135
Storage Temperature ($^\circ\text{C}$)	-40 to +120	-40 to +120
Soldering Temperature ($^\circ\text{C}$) ^[2]	260 for 5 seconds max	260 for 5 seconds max
ESD Sensitivity ^[3]	$\pm 16,000\text{V}$ HBM	$\pm 16,000\text{V}$ HBM

Notes for Table 11:

1. Proper current derating must be observed to maintain junction temperature below the maximum. For more information, consult the Luxeon Design Guide, available upon request.
2. Measured at leads, during lead soldering and slug attach, body temperature must not exceed 120°C . Luxeon Emitters cannot be soldered by general IR or Vapor-phase reflow, nor by wave soldering. Lead soldering is limited to selective heating of the leads, such as by hot-bar reflow, fiber focussed IR, or hand soldering. The package back plane (slug) may not be attached by soldering, but rather with a thermally conductive adhesive. Electrical insulation between the slug and the board is required. Please consult Lumileds' Application Brief AB10 on *Luxeon Emitter Assembly Information* for further details on assembly methods.
3. LEDs are not designed to be driven in reverse bias. Please consult Lumileds' Application Brief AB11 for further information.

Wavelength Characteristics, $T_J = 25^\circ\text{C}$

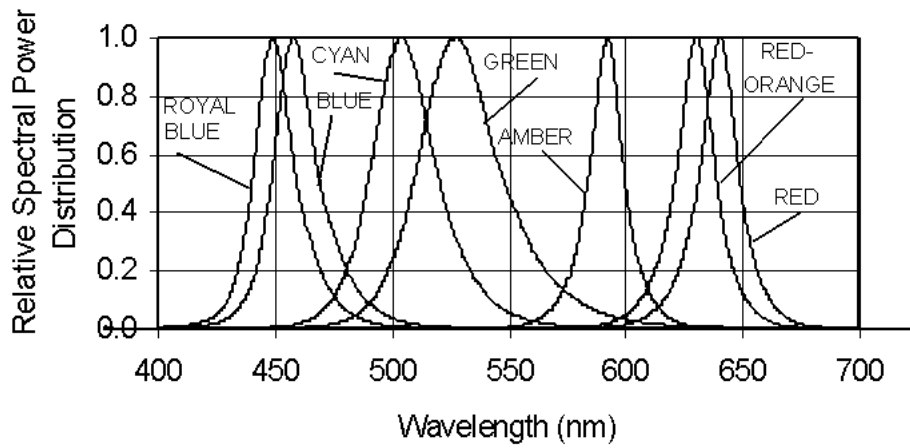

Figure 1a. Relative Intensity vs. Wavelength

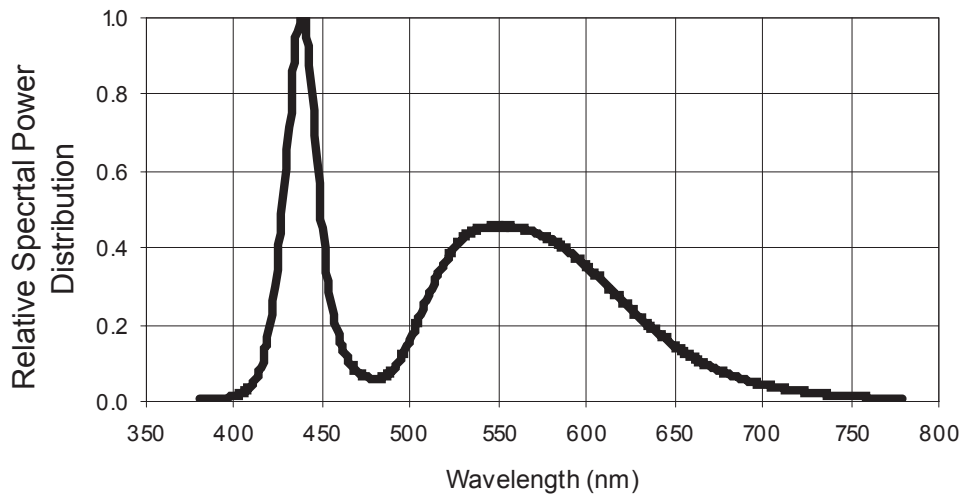

Figure 1b. White Color Spectrum of Typical 5500K CCT Part, Integrated Measurement.

Light Output Characteristics

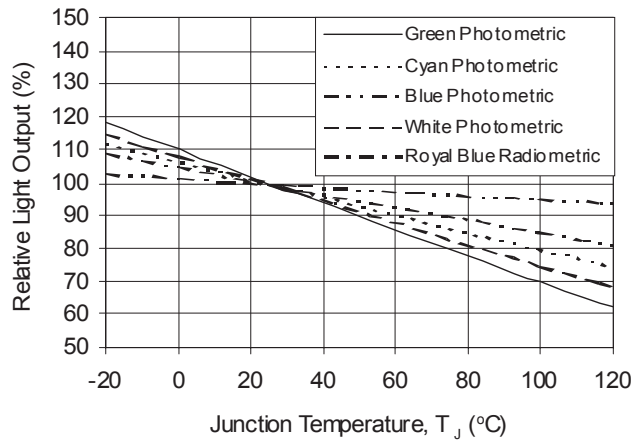

Figure 2. Relative Light Output vs. Junction Temperature for White, Green, Cyan, Blue and Royal Blue.

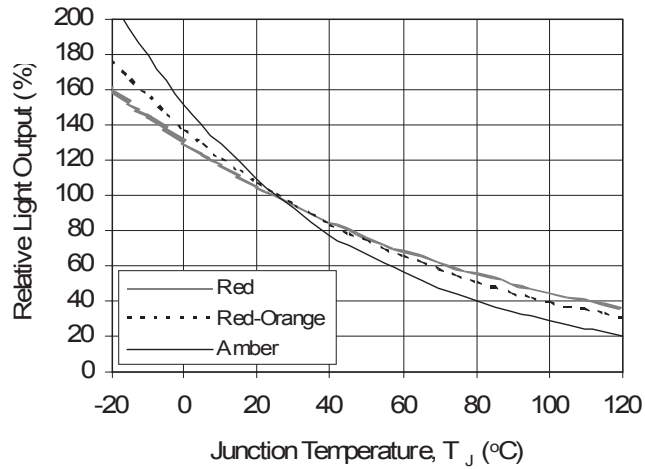

Figure 3. Relative Light Output vs. Junction Temperature for Red, Red-Orange and Amber.

Forward Current Characteristics, $T_J = 25^\circ\text{C}$

Note:

Driving these high power devices at currents less than the test conditions may produce unpredictable results and may be subject to variation in performance. Pulse width modulation (PWM) is recommended for dimming effects.

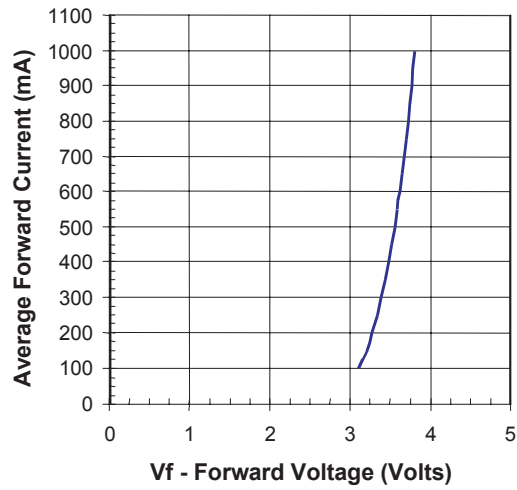

Figure 4. Forward Current vs. Forward Voltage for White, Green, Cyan, Blue, and Royal Blue.

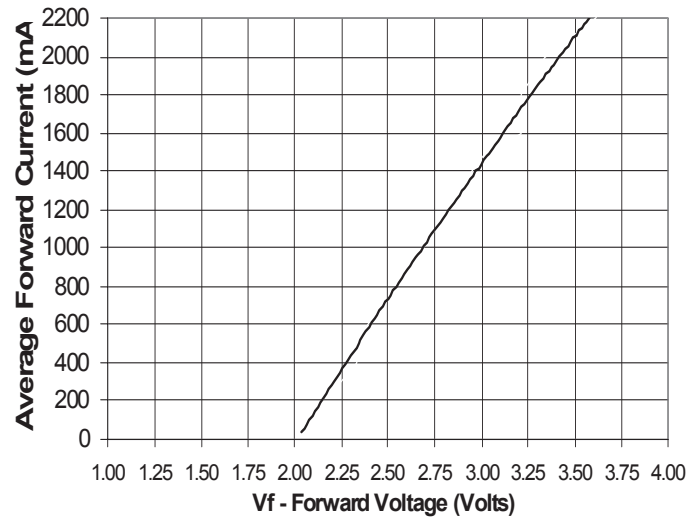

Figure 5. Forward Current vs. Forward Voltage for Red, Red-Orange and Amber.

Forward Current Characteristics, $T_J = 25^\circ\text{C}$, Continued

Note:

Driving these high power devices at currents less than the test conditions may produce unpredictable results and may be subject to variation in performance. Pulse width modulation (PWM) is recommended for dimming effects.

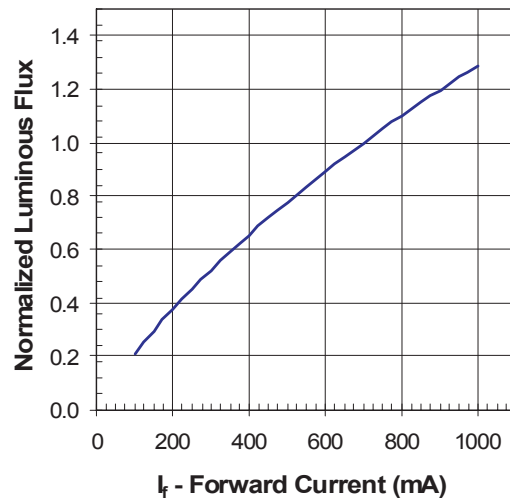

Figure 6. Relative Luminous Flux vs. Forward Current for White, Green, Cyan, Blue, and Royal Blue at $T_J = 25^\circ\text{C}$ maintained.

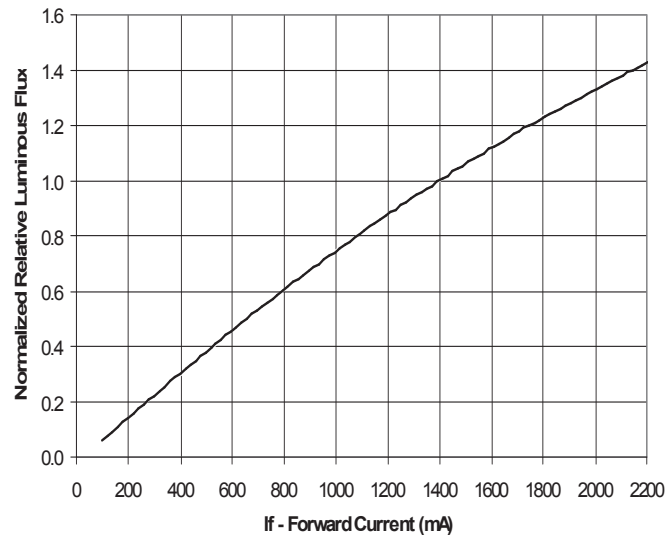

Figure 7. Relative Luminous Flux vs. Forward Current for Red, Red-Orange and Amber at $T_J = 25^\circ\text{C}$ maintained.

Current Derating Curves

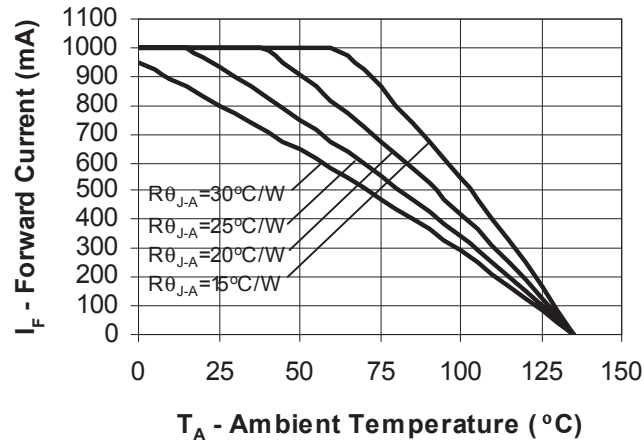

Figure 8. Maximum Forward Current vs. Ambient Temperature.

Derating based on $T_{JMAX} = 135^\circ\text{C}$ for White, Green, Cyan, Blue, and Royal Blue. Since Luxeon III may be driven at up to 1000mA, derating curves may not be applicable for all operating conditions.

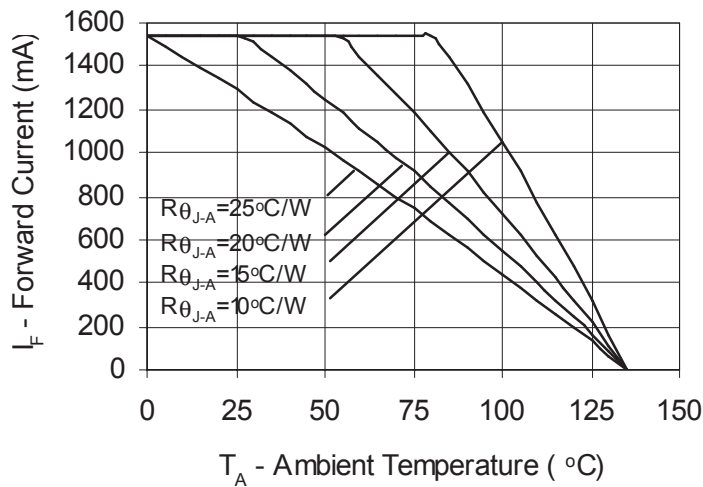

Figure 9. Maximum Forward Current vs. Ambient Temperature derating based on $T_{JMAX} = 135^\circ\text{C}$ for Red, Red-Orange, and Amber.

Typical Lambertian Representative Spatial Radiation Pattern

Note:

For more detailed technical information regarding Luxeon radiation patterns, please consult your Lumileds Authorized Distributor or Lumileds sales representative.

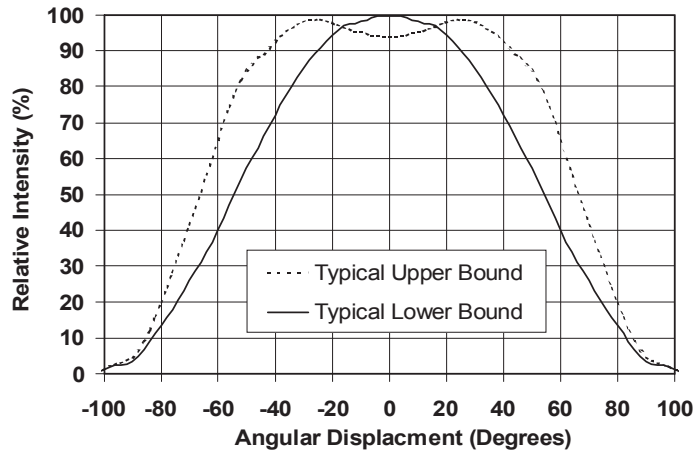

Figure 10. Typical Representative Spatial Radiation Pattern for Luxeon Emitter White, Green, Cyan, Blue and Royal Blue.

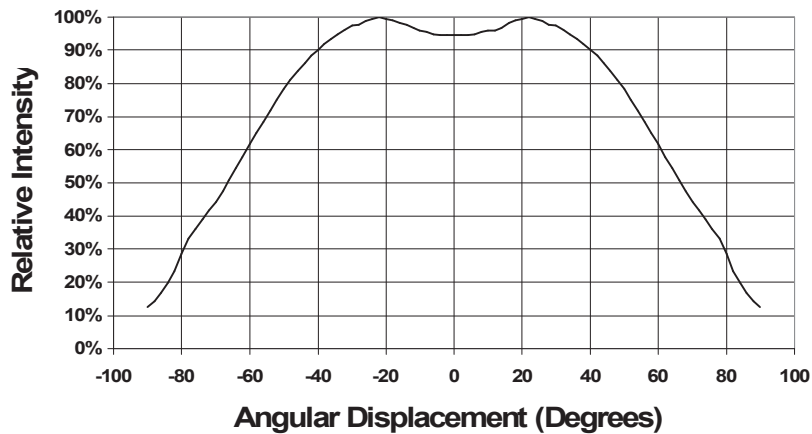

Figure 11. Typical Representative Spatial Radiation Pattern for Luxeon Lambertian Emitter Red, Red-Orange and Amber.

Typical Side Emitting Representative Spatial Radiation Pattern

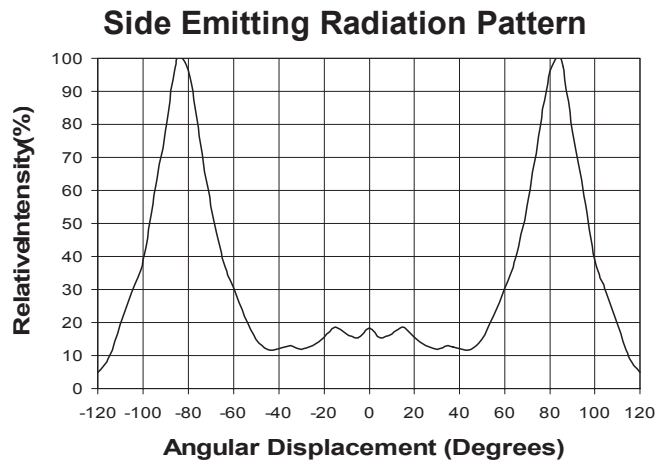

Figure 12. Typical Representative Spatial Radiation Pattern for Luxeon Emitter White, Green and Blue.

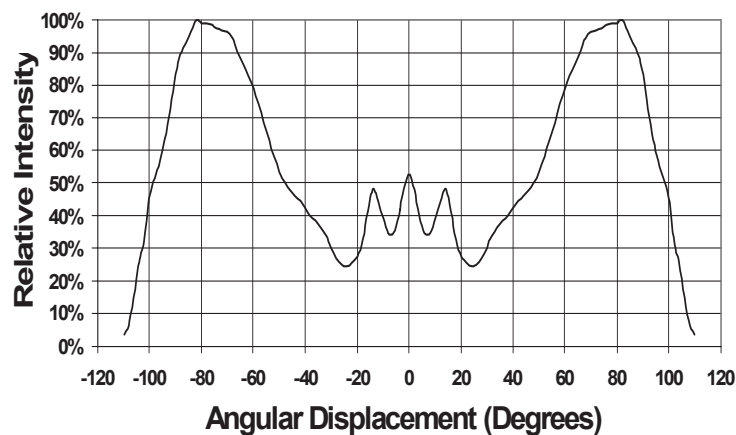

Figure 13. Typical Representative Spatial Radiation Pattern for Luxeon Emitter Red, Red-Orange and Amber.

Average Lumen Maintenance Characteristics

Lifetime for solid-state lighting devices (LEDs) is typically defined in terms of lumen maintenance—the percentage of initial light output remaining after a specified period of time. Lumileds projects that white, green, cyan, blue, and royal blue Luxeon III products will deliver, on average, 70% lumen maintenance at 50,000 hours of operation at a 700 mA forward current or 50% lumen maintenance at 20,000 hours of operation at a 1000 mA forward current. Lumileds projects that red, red-orange, and amber Luxeon III products will deliver, on average 50% lumen maintenance at 20,000 hours of operation at a 1400 mA forward current. This performance is based on independent test data, Lumileds historical data from tests run on similar material systems, and internal Luxeon reliability testing. This projection is based on constant current operation with junction temperature maintained at or below 90°C. Observation of design limits included in this data sheet is required in order to achieve this projected lumen maintenance.

Emitter Reel Packaging

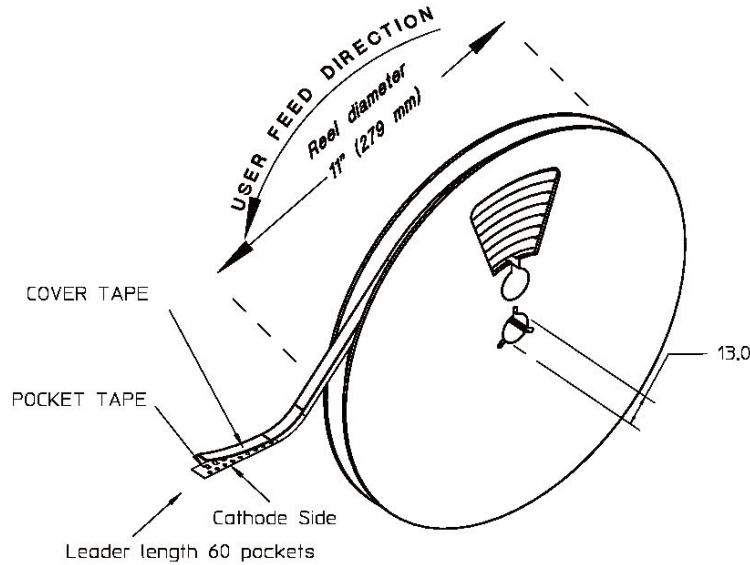

Figure 14. Reel dimensions and orientation.

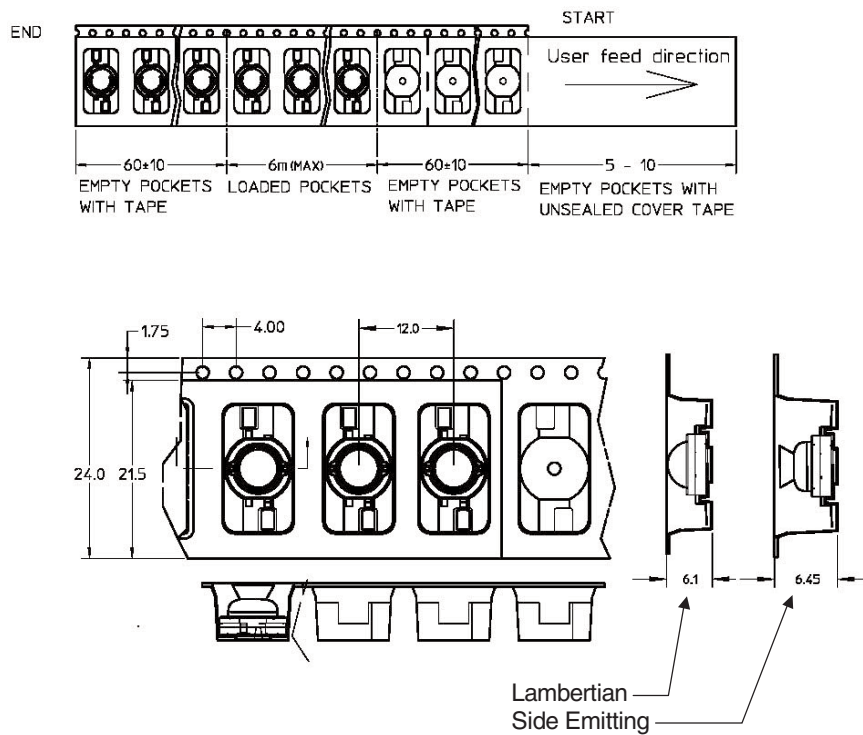

Figure 15. Tape dimensions for Lambertian and Side Emitting radiation pattern.

Notes:

1. Luxeon emitters should be picked up by the body (not the lens) during placement. The inner diameter of the pick-up collet should be greater than or equal to 6.5 mm. Please consult Lumileds' Application Brief AB10 on Luxeon Emitter assembly information for further details on assembly methods.
2. Drawings not to scale.
3. All dimensions are in millimeters.
4. All dimensions without tolerances are for reference only.

Company Information

Luxeon is developed, manufactured and marketed by Lumileds Lighting, U.S., LLC. Lumileds is a world-class supplier of Light Emitting Diodes (LEDs) producing billions of LEDs annually. Lumileds is a fully integrated supplier, producing core LED material in all three base colors (Red, Green, Blue) and White. Lumileds has R&D development centers in San Jose, California and Best, The Netherlands and production capabilities in San Jose, California and Malaysia. Lumileds Lighting is a joint venture of Agilent Technologies and Philips Lighting and was founded in 1999. Lumileds is pioneering the high-flux LED technology and bridging the gap between solid-state LED technology and the lighting world. Lumileds is absolutely dedicated to bringing the best and brightest LED technology to enable new applications and markets in the Lighting world.

Lumileds may make process or materials changes affecting the performance or other characteristics of our products. These products supplied after such changes will continue to meet published specifications, but may not be identical to products supplied as samples or under prior orders.



WWW.LUXEON.COM
WWW.LUMILEDSFUTURE.COM

FOR TECHNICAL ASSISTANCE OR THE
LOCATION OF YOUR NEAREST SALES
OFFICE CONTACT ANY OF THE
FOLLOWING:

NORTH AMERICA:
+1 888 589 3662 OR
ASKLUXEON@FUTUREELECTRONICS.COM

EUROPE:
OO 800 443 88 873 OR
LUXEON.EUROPE@FUTUREELECTRONICS.COM

ASIA:
800 5864 5337 OR
LUMILEDS.ASIA@FUTUREELECTRONICS.COM