

Edixeon[®] Federal Series

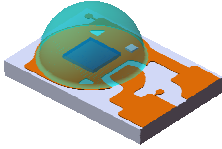

Edixeon[®] Federal is a surface mount, compact, high brightness LED that is built for various illumination needs. A single Cool White Edixeon[®] Federal can deliver typical luminous flux of 80 lm while driving at 350mA suitable for any kind of lighting sources, including general illumination, flashlights, streetlights, spotlights, signal lights, industrial and commercial lightings. The small physical dimension can free customers from any constraints or limitations in these fields of applications. Furthermore, the reflow-solderable nature of Edixeon[®] Federal provides an easy path towards the optimum thermal management to achieve a promising reliability. In conclusion, Edixeon[®] Federal offers you an extraordinary LED experience.

Features

- High lumen performance, 80lm at 350mA for Cool White Edixeon[®] Federal
- Promising lumen maintenance characteristics
- High efficiency package
- Level 1 on JEDEC moisture sensitivity analysis
- 350mA – 700mA drive current
- RoHS compliant

Typical Applications

- Reading lights
- Up-lights and Down-lights
- General lighting
- Ceiling lights
- Decoration lights
- Beacon lights
- Portable flashlight
- LCD Backlights
- Contour lights
- Garden lighting
- Architectural lighting

Table of Contents

Edixeon® Federal Nomenclature	3
Environmental Compliance	3
E-Type Package Dimensions	4
E-Type Package Polarity	5
Absolute Maximum Rating	6
Luminous Flux Characteristics	6
Forward Voltage Characteristics	9
JEDEC Moisture Sensitivity	9
Edixeon® Federal Reliability Items and Failure Criteria	10
Color Spectrum & Radiation Pattern	11
Optical and Electrical Curves	12
Edixeon® Federal Reflow Soldering Instructions	20
Product Packaging	21
Edixeon® Federal Bin Groups	23

Edixeon® Federal Nomenclature:

E F E W - 1 A E 1
 X1 X2 X3 X4 X5 X6 X7

Table 1.

X1		X2		X3			X4		X5	
LED Item		Module		Emitting Color			Power		Substrate Type	
Code	Type	Code	Type	Code	Type		Code	Type	Code	Type
EF	Edixeon Federal	E	Emitter	W	White	○	1	350mA	A	4.5mm x 3mm
		S	Star	H	Neutral White	●	3	700mA		
				X	Warm White	●				
				R	Red	●				
				A	Amber	●				
				T	Green	●				
				B	Blue	●				
				D	Dental Blue	●				
				C	Royal Blue	●				
				J	Cyan	●				
				E	Deep Red	●				
				F	Cherry Red	●				
				V	Ultraviolet	●				

X6		X7	
Emitter Type		Internal Usage	
Code	Type	Code	Type
E	E-type	1	

Environmental Compliance:

Edixeon® Federal is compliant to the Restriction of Hazardous Substances Directive or RoHS. The restricted materials including lead, mercury cadmium hexavalent chromium, polybrominated biphenyls (PBB) and polybrominated diphenyl ether (PBDE) are not used in Edixeon® Federal to provide an environmentally friendly product to the customers.

E-Type Package Dimensions:

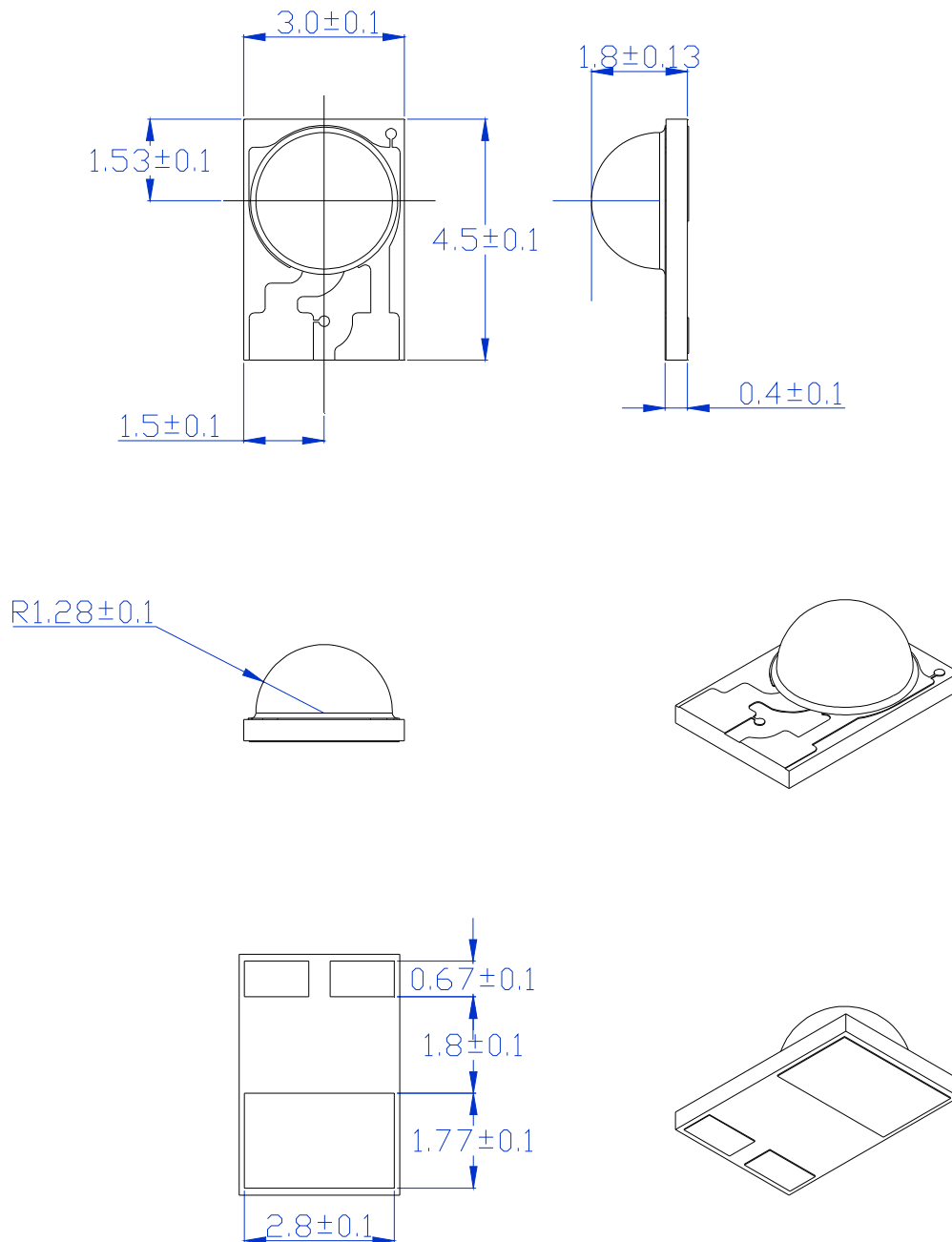
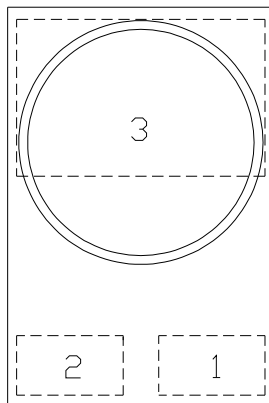

Figure 3: E-Type Package Drawings

Notes:

1. All dimensions are in millimeters.
2. Drawings are not to scale.

E-Type Package Polarity:



TOP

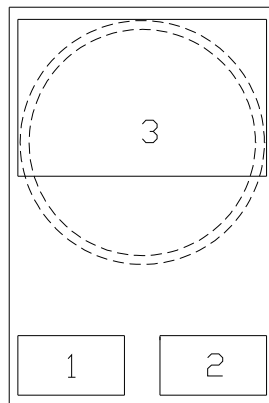

BOTTOM

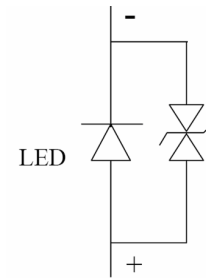

PAD	FUNCTION
1	ANODE
2	CATHODE
3	THERMAL

Figure 4: E-Type Pad Configuration

Note:

The thermal pad is electrically connected to anode.

Absolute Maximum Ratings:

Table 2.

Parameter	Symbol	Rating	Units
DC Forward Current ^[1]	I_F	350 / 700	mA
Peak Pulsed Current; ($t_p \leq 100\mu s$, Duty cycle=0.25)	I_{pulse}	1000	mA
Isolation Voltage	V_i	1000	V
Transient Surge Voltage	V_{TS}	8	V
Reverse Voltage ^[2]	V_r	Note 2	V
LED Junction Temperature ^[3]	T_j	150 / 125 ^[4]	°C
Operating Temperature	T_{opr}	-40 ~ +80	°C
Storage Temperature	T_{stg}	-40 ~ +120	°C
ESD Sensitivity	V_B	2,000	V
Allowable Reflow Cycles	n/a	3	cycles
Soldering Temperature	T_{sol}	260	°C

Notes:

1. Maximum forward current for 1W and 3W are 350mA and 700mA respectively.
2. LEDs are not designed to drive in reverse bias.
3. Proper current derating must be observed to maintain junction temperature below the maximum.
4. The maximum junction temperature for Red, Amber, Deep Red and Cherry Red is 125°C.

Luminous Flux Characteristics, $I_F=350\text{mA}$ and Thermal Pad= 25°C :

Table 3.

Power Consumption	Part Name	Color	Flux			Units	
			Min.	Typ.	Max.		
1W	EFEW-1AE1	Cool White	--	80	--	lm	
	EFEH-1AE1	Neutral White	--	65	--	lm	
	EFEY-1AE1	Warm White	--	55	--	lm	
	EFER-1AE1	Red	--	40	--	lm	
	EFEA-1AE1	Amber	--	40	--	lm	
	EFET-1AE1	True Green	--	70	--	lm	
	EFEB-1AE1	Blue	--	18	--	lm	
	EFED-1AE1	Dental Blue	--	180	--	mW	
	EFEK-1AE1	Royal Blue	--	200	--	mW	
	EFEJ-1AE1	Cyan	--	30	--	lm	
	EFEF-1AE1	Deep Red	--	135	--	mW	
	EFEV-1AE1	Cherry Red	--	110	--	mW	
		EFEV-1AE1	Ultraviolet	--	160	--	mW

Luminous Flux Characteristics, $I_F=700\text{mA}$ and Thermal Pad= 25°C :

Table 4.

Lens Item	Part Name	Color	Flux			Units
			Min.	Typ.	Max.	
3W	EFEW-3AE1	Cool White	--	136	--	lm
	EFEH-3AE1	Neutral White	--	110	--	lm
	EFEY-3AE1	Warm White	--	100	--	lm
	EFER-3AE1	Red	--	65	--	lm
	EFET-3AE1	True Green	--	110	--	lm
	EFEB-3AE1	Blue	--	27	--	lm

Note:

The luminous flux performance is guaranteed within published operating conditions. Edison maintains a tolerance of $\pm 10\%$ on flux measurements.

Color Temperature or Dominant/Peak Wavelength Characteristics, $T_J=25^\circ\text{C}$ at 350mA :

Table 5.

Power Consumption	Part Name	Color	CCT/Wavelength			Units
			Min.	Typ.	Max.	
1W	EFEW-1AE1	Cool White	5,000	--	10,000	K
	EFEH-1AE1	Neutral White	3,800	--	50,00	K
	EFEY-1AE1	Warm White	2,670	--	3,800	K
	EFER-1AE1	Red	620	--	630	nm
	EFEA-1AE1	Amber	585	--	595	nm
	EFEV-1AE1	True Green	515	--	535	nm
	EFEF-1AE1	Blue	455	--	475	nm
	EFEJ-1AE1	Dental Blue ^[1]	450	--	470	nm
	EFEK-1AE1	Royal Blue ^[1]	440	--	460	nm
	EFEI-1AE1	Cyan	490	--	510	nm
	EFEU-1AE1	Deep Red ^[1]	650	--	670	nm
	EFEV-1AE1	Cherry Red ^[1]	730	--	750	nm
	EFEW-1AE1	Ultraviolet ^[1]	395	--	410	nm

Notes:

1. Wavelengths are stated as peak wavelength.
2. Edison maintains a tolerance of $\pm 0.5\text{nm}$ for dominant wavelength, $\pm 2\text{nm}$ for peak wavelength and $\pm 5\%$ on CCT measurement.

Forward Voltage Characteristics, $T_J=25^\circ\text{C}$:

Table 6.

Power Consumption	Part Name	Color	Forward Current (mA)	V_F			Units
				Min.	Typ.	Max.	
1W	EFEW-1AE1	White	350	3.0	--	4.0	V
	EFEH-1AE1	Neutral White	350	3.0	--	4.0	
	EFEK-1AE1	Warm White	350	3.0	--	4.0	
	EFER-1AE1	Red	350	2.0	--	3.0	
	EFEA-1AE1	Amber	350	2.0	--	3.0	
	EFET-1AE1	True Green	350	2.8	--	4.0	
	EFEV-1AE1	Blue	350	3.0	--	4.0	
	EFED-1AE1	Dental Blue	350	3.0	--	4.0	
	EFEJ-1AE1	Royal Blue	350	3.0	--	4.0	
	EFEI-1AE1	Cyan	350	2.8	--	4.0	
	EFEF-1AE1	Deep Red	350	2.0	--	3.0	
	EFEV-1AE1	Cherry Red	350	2.0	--	3.0	
	EFEV-1AE1	Ultraviolet	350	3.0	--	4.0	
3W	EFEW-3AE1	White	700	3.0	--	4.0	V
	EFEH-3AE1	Neutral White	700	3.0	--	4.0	
	EFEK-3AE1	Warm White	700	3.0	--	4.0	
	EFER-3AE1	Red	700	2.0	--	3.0	
	EFET-3AE1	True Green	700	2.8	--	4.0	
	EFEV-3AE1	Blue	700	3.0	--	4.0	

Note:

Edison maintains a tolerance of 0.06V on forward voltage measurement.

Emission Angle Characteristics:

Table 7.

$2\Theta^{1/2}$ (Typ.) Lambertian	Units
120	Degrees

JEDEC Moisture Sensitivity:

Table 8.

Level	Floor Life		Soak Requirements	
	Time	Conditions	Time (hours)	Standard Conditions
1	unlimited	$\leq 30^{\circ}\text{C} / 85\%$ RH	168 +5/-0	$85^{\circ}\text{C} / 85\%$ RH

Thermal Resistance – Junction to Thermal Pad:

Table 9.

Thermal Resistance from Junction to Thermal Pad	Units
10	$^{\circ}\text{C} / \text{W}$

Operating Life, Mechanical and Environmental Tests on Edixeon® Federal:

Table 10.

Stress Test	Stress Conditions	Stress Duration	Failure Criteria
Room Temperature Operating Life	55 °C, I _F =DC max ^[1]	1000 hours	Note 2
High Temperature High Humidity Operating Life	85 °C / 85%RH, I _F =DC max ^[1]	1000 hours	Note 2
High Temperature Operating Life	85 °C, I _F =DC max ^[1]	1000 hours	Note 2
Low Temperature Operating Life	-40 °C, I _F =DC max ^[1]	1000 hours	Note 2
High Temperature Storage Life	150 °C	1000 hours	Note 2
Low Temperature Storage Life	-40 °C	1000 hours	Note 2
Non-Operating Thermal Shock	-40 / 125°C, 20 min dwell < 10 sec transfer	500 cycles	No catastrophic
Mechanical Shock	1500 G, 0.5 msec pulse, 5 shocks each 6 axis	N/A	No catastrophic
Free Drop	On concrete from 1.2 m, 3X	N/A	No catastrophic
Variable Vibration Frequency	10-2000-10 Hz, log or linear sweep rate, 20 G about 1 min, 1.5 mm, 3X/axis	N/A	No catastrophic
Solder Heat Resistance (SHR)	Three JEDEC Pb-free reflow profile	N/A	No catastrophic

Note:

1. DC max is defined to be 350mA and 700mA for 1W and 3W Edixeon® Federal respectively.

2. Failure Criteria:

- Electrical failures: V_F shifts >= 10%
- Light Output Degradation: Percentage level shift >= 50% at 1,000hrs or 500cycle
- Visual failures: Broken or damaged package on lens or substrate

White Edixeon® Federal Color Spectrum, $T_j = 25^\circ\text{C}$:

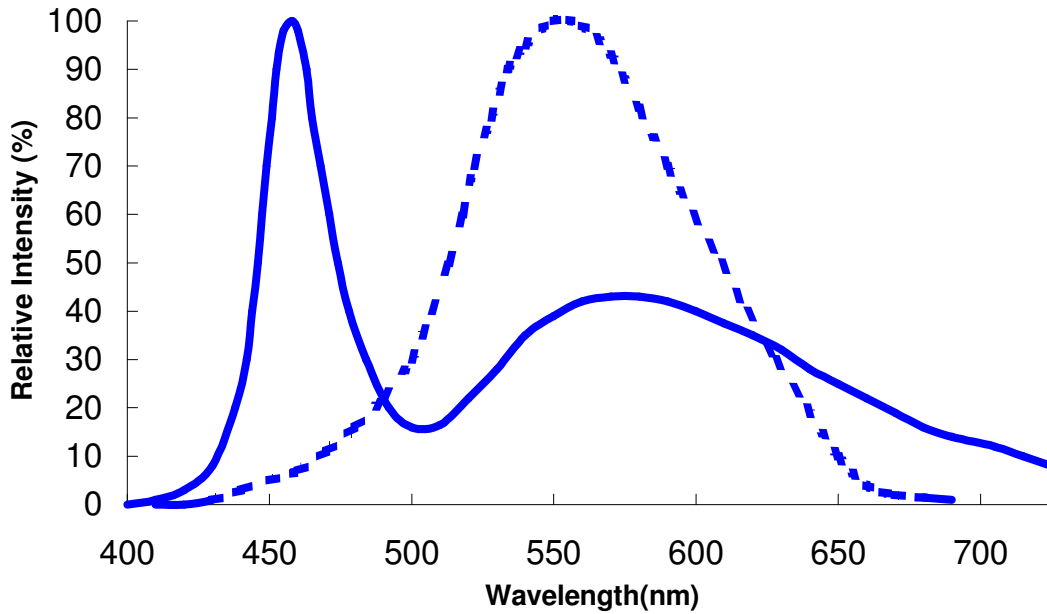

Figure 5: Color Spectrum for Cool White at a typical CCT. Dotted curve represents the standard eye response, $T_j=25^\circ\text{C}$.

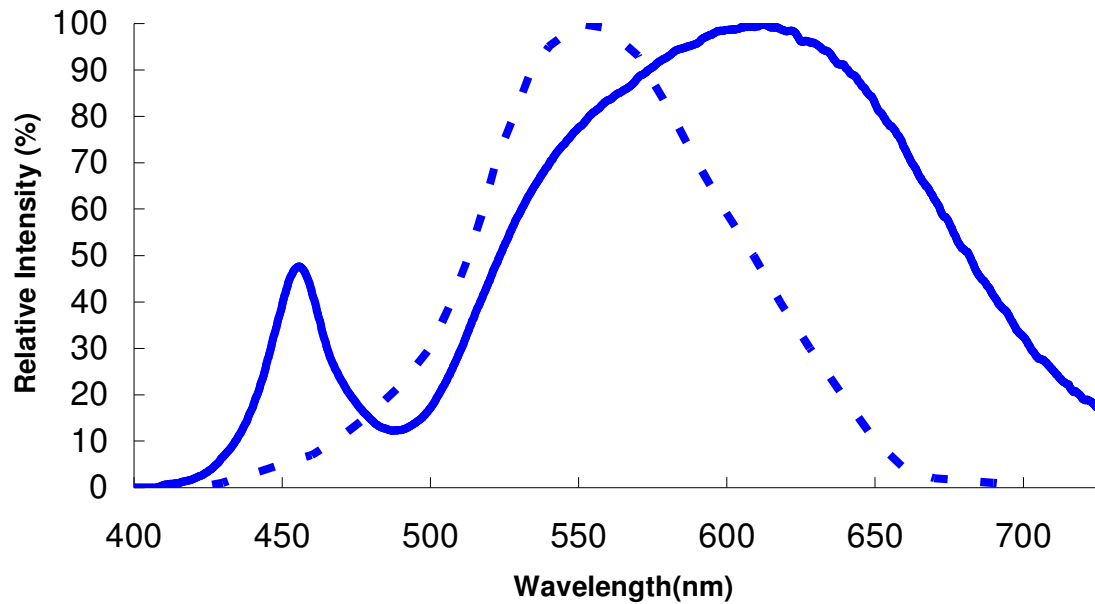

Figure 6: Color Spectrum for Neutral White and Warm White at a typical CCT. Dotted curve represents the standard eye response, $T_j=25^\circ\text{C}$.

Typical Radiation Pattern, $T_j = 25^\circ\text{C}$:

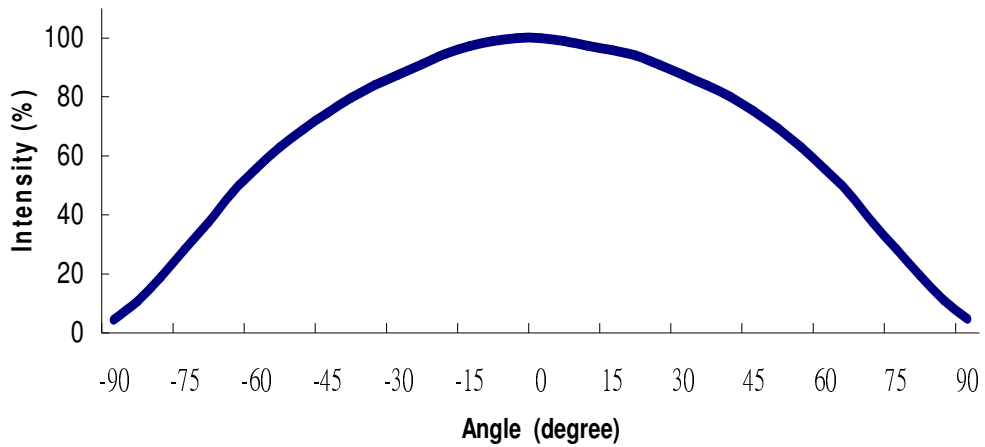

Figure 7: Lambertian Pattern for all colors at $T_j=25^\circ\text{C}$..

Optical & Electric Curves:

Current Derating Curve for 700mA Drive Current, $T_j = 150^\circ\text{C}$

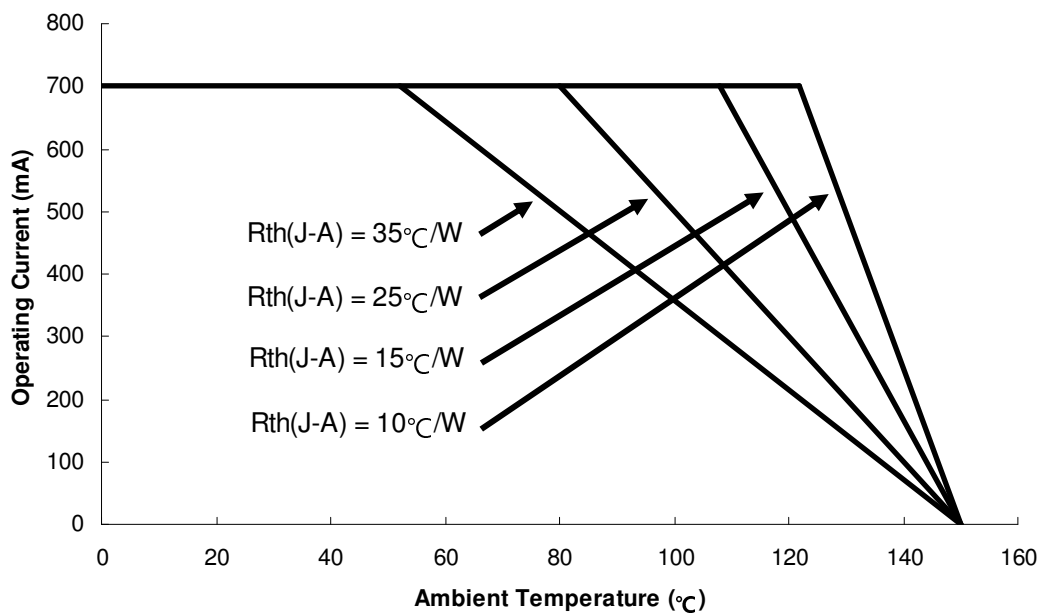

Figure 8: Maximum Operating Current vs Ambient Temperature for White, Blue, Green, Cyan, Royal Blue, Dental Blue and Ultraviolet.

Current Derating Curve for 700mA Drive Current, $T_j = 125^\circ\text{C}$

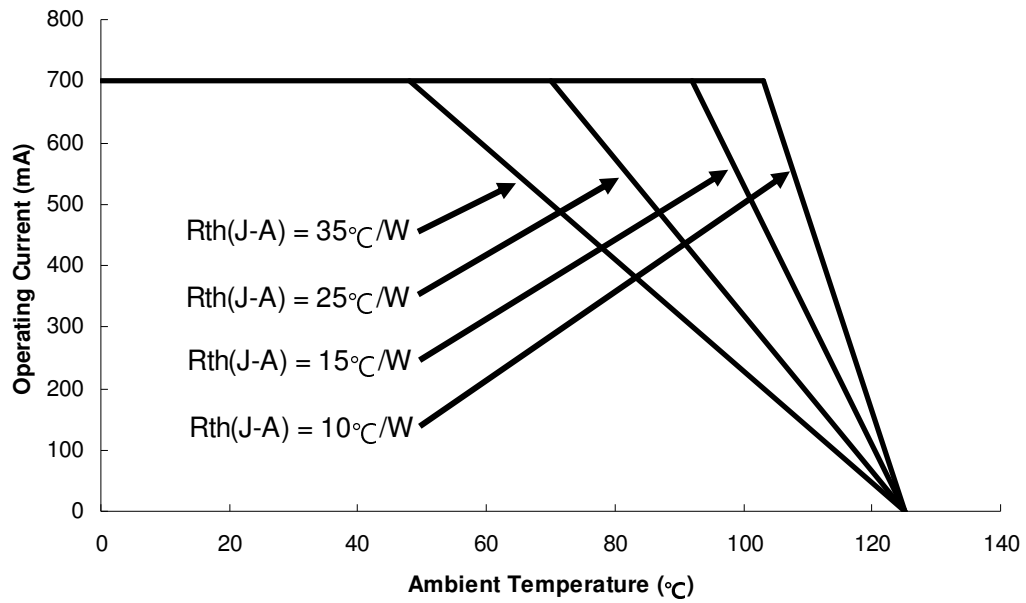

Figure 9: Maximum Operating Current vs Ambient Temperature for Red, Amber, Deep Red, Cherry Red.

Typical Forward Voltage Characteristics for White and Blue Edixeon® Federal, $T_j = 25^\circ\text{C}$

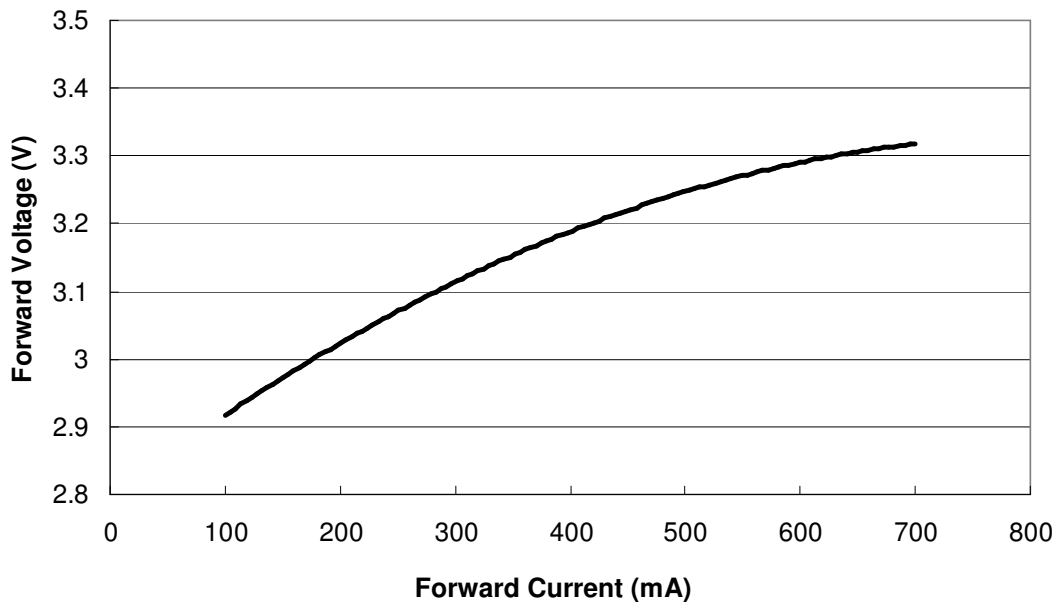

Figure 10: Forward voltage vs. forward current for White and Blue.

**Typical Forward Voltage Characteristics for
True Green, $T_j = 25^\circ\text{C}$**

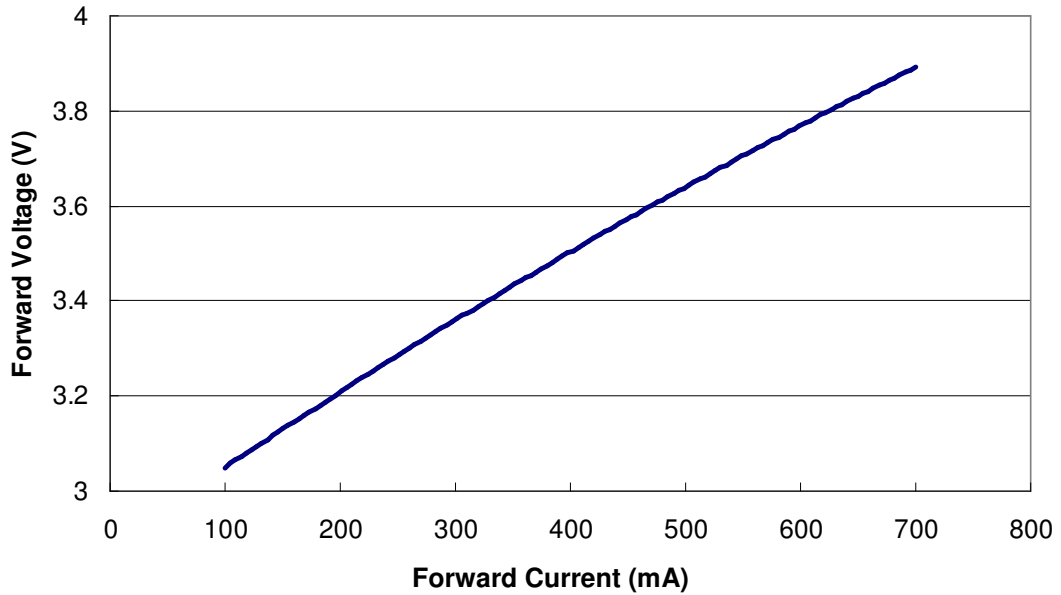

Figure 11: Forward voltage vs. forward current for True Green.

**Typical Forward Voltage Characteristics for
Red and Amber, $T_j = 25^\circ\text{C}$**

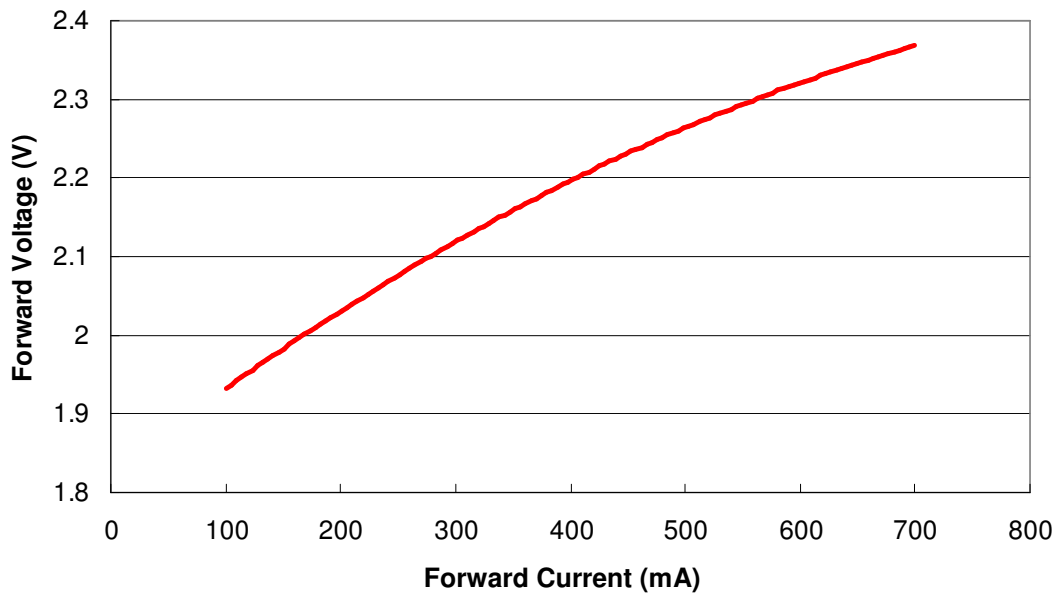

Figure 12: Forward voltage vs. forward current for Red and Amber.

Typical Relative Luminous Flux for Cool White, True Green and Blue, $T_j = 25^\circ\text{C}$

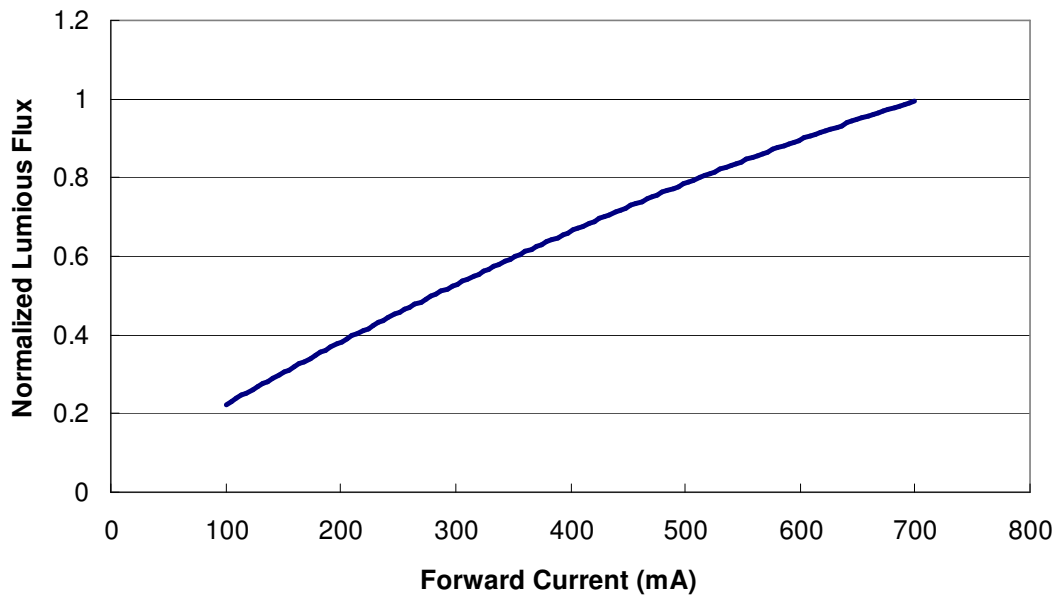

Figure 13: Relative luminous flux vs. forward current for Cool White, True Green and Blue.

Typical Relative Luminous Flux for Red and Amber, $T_j = 25^\circ\text{C}$

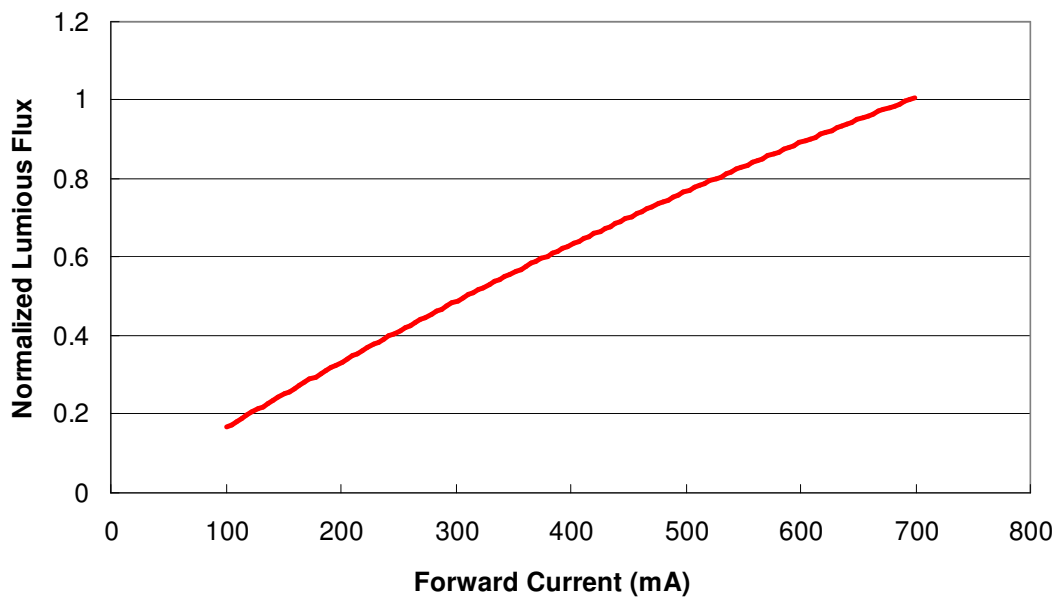

Figure 14: Relative luminous flux vs. forward current for Red and Amber.

Typical Wavelength Shift Characteristic for True Green and Blue, $T_j = 25^\circ\text{C}$

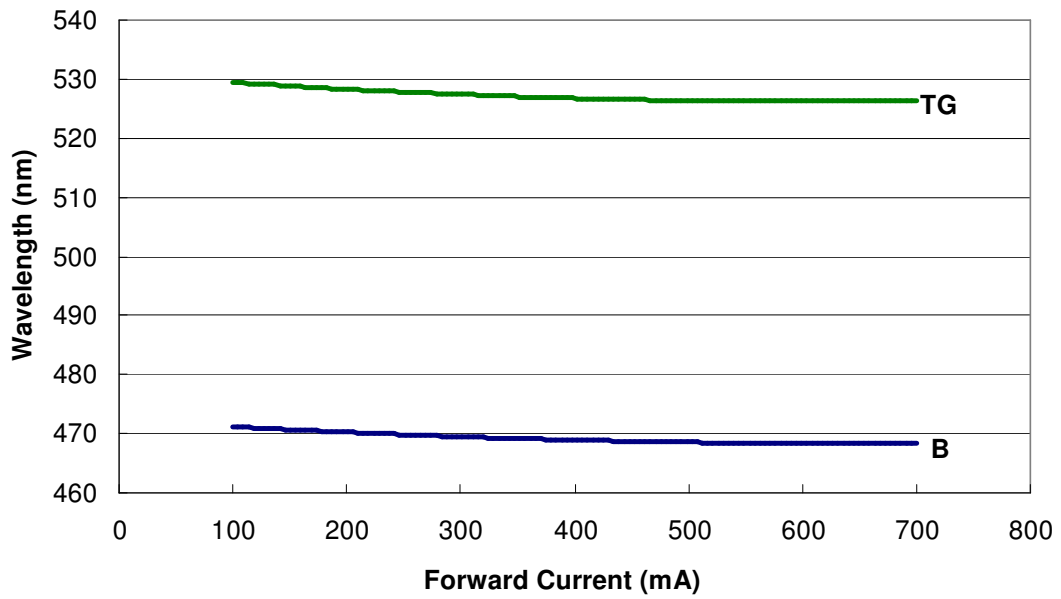

Figure 15: Wavelength length vs. forward current for True Green and Blue.

Typical Wavelength Shift Characteristic for Red and Amber, $T_j = 25^\circ\text{C}$

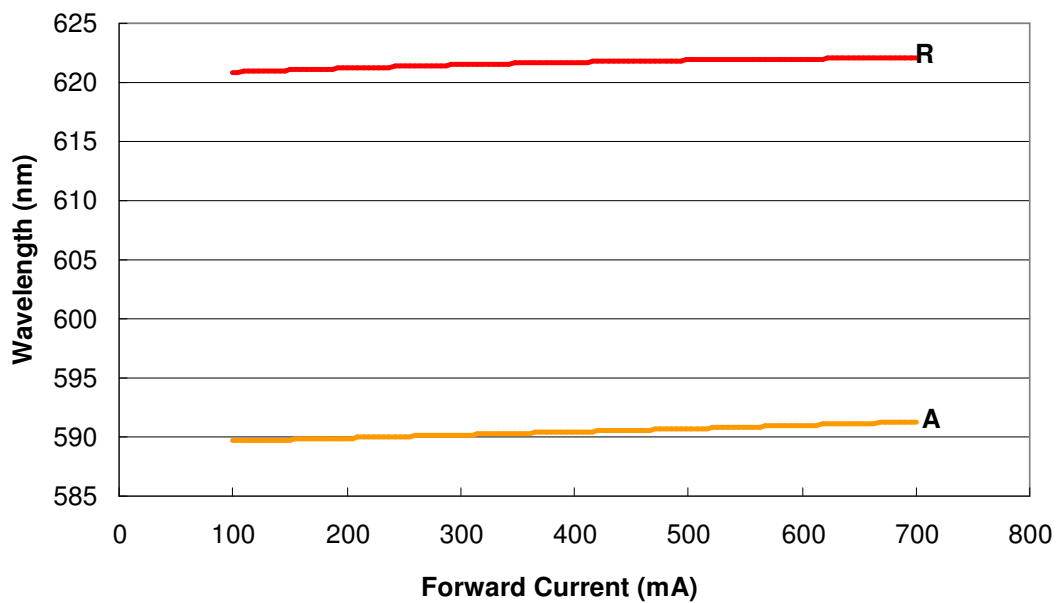

Figure 16: Wavelength length vs. forward current for Red and Amber.

Typical CCT Shift Characteristic for Cool White $T_j = 25^\circ\text{C}$

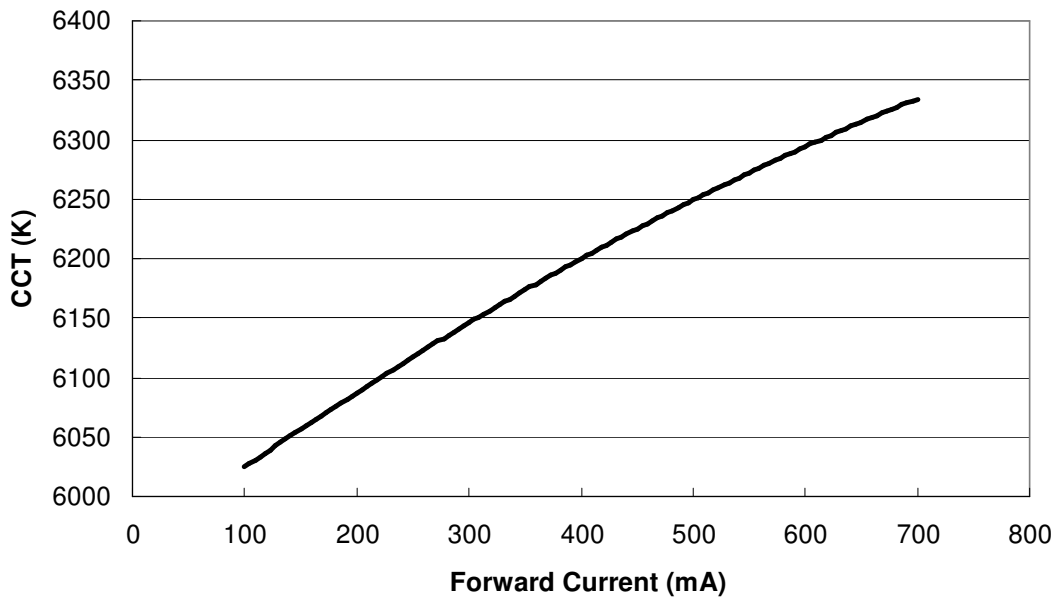

Figure 17: CCT vs. forward current for Cool White.

Typical CCT Shift Characteristic for Cool White

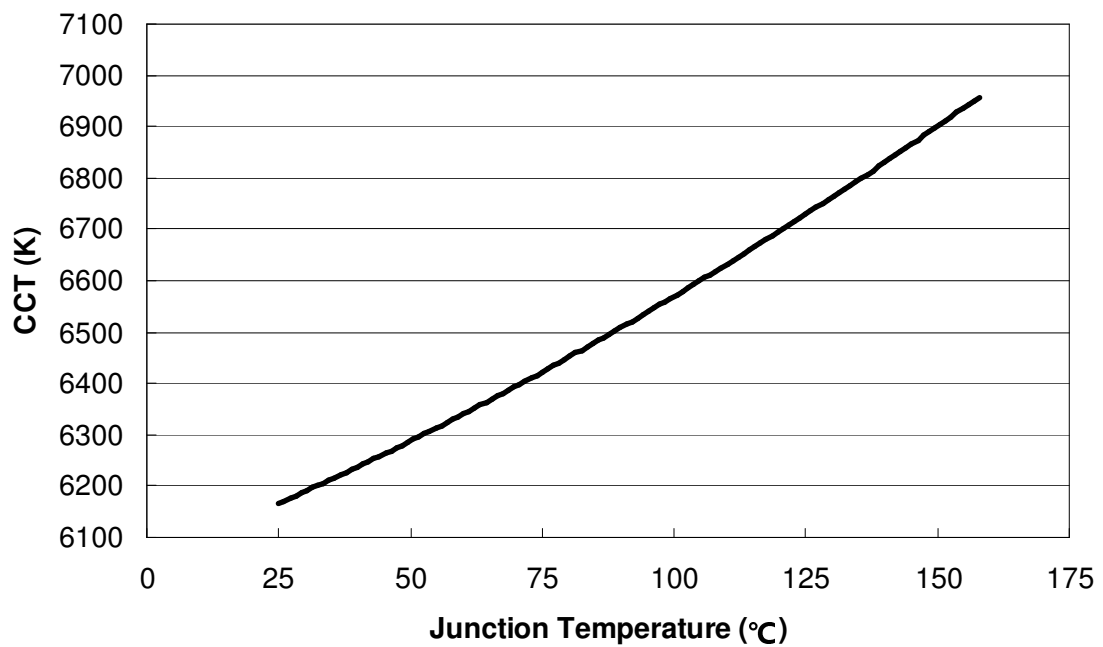

Figure 18: Typical CCT vs. junction temperature for Cool White.

Typical Light Output Characteristics over Thermal Pad Temperature for Cool White

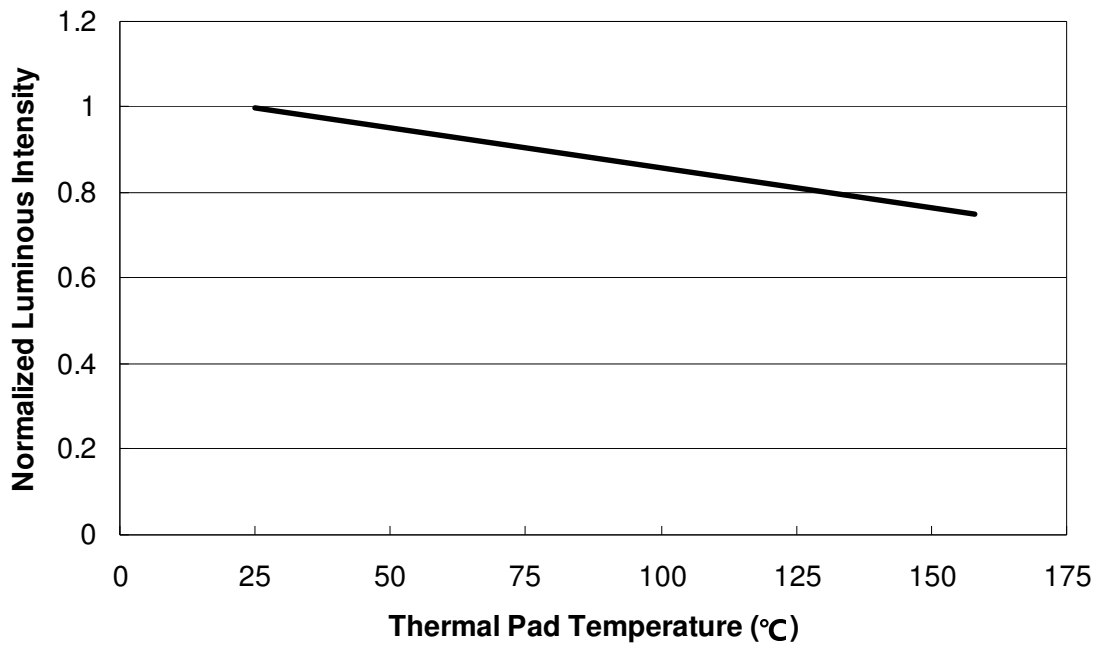

Figure 19: Relative luminous flux vs. thermal pad temperature for Cool White.

Typical Light Output Characteristics over Thermal Pad Temperature for True Green, Blue, Red and Amber

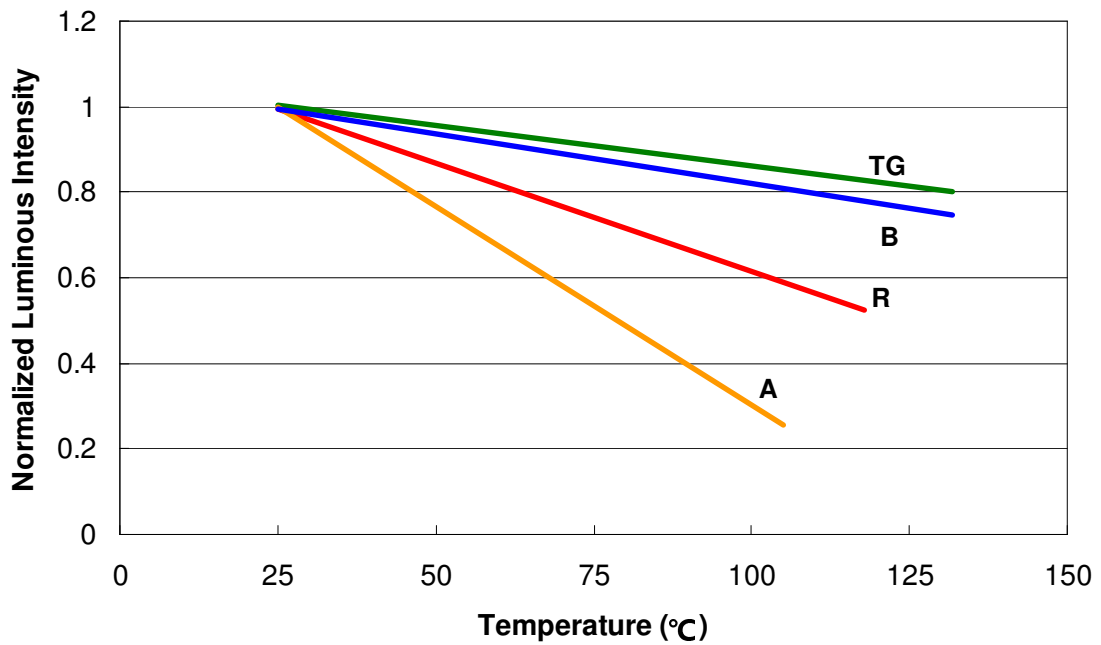

Figure 20: Relative luminous flux vs. thermal pad temperature for True Green, Blue, Red and Amber.

Reflow Profile:

The following reflow profile is from IPC/JEDEC J-STD-020D which provided here for reference.

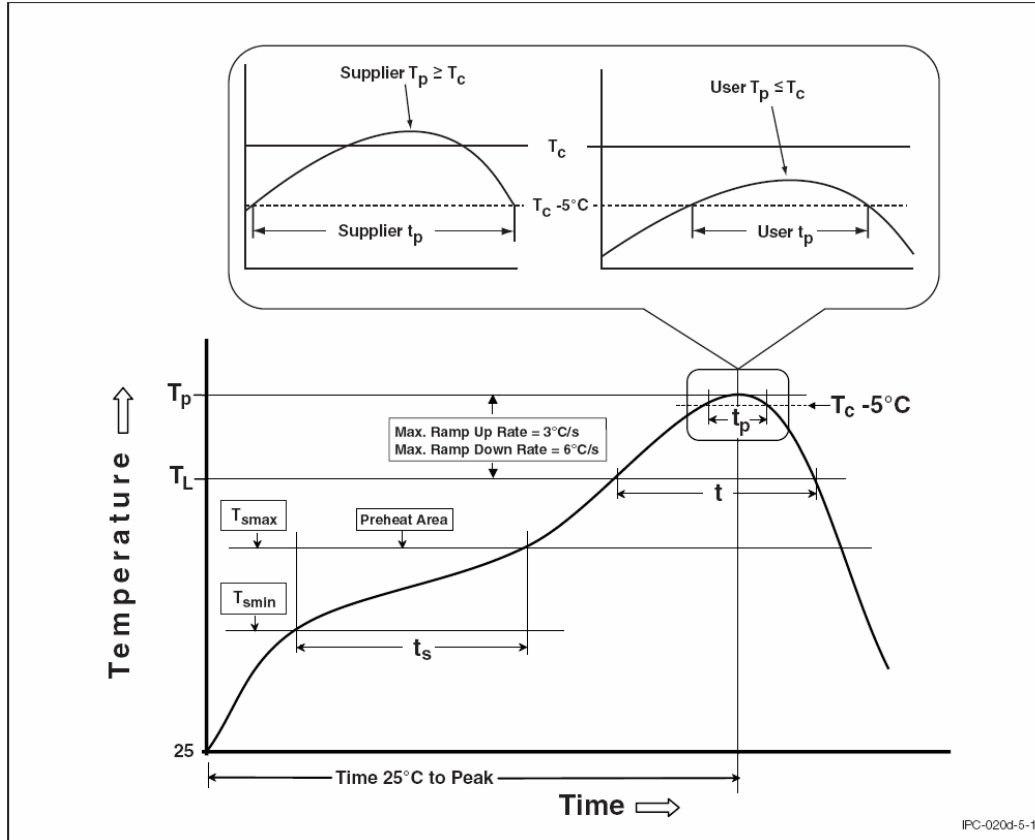

Table 11.

Profile Feature	Sn-Pb Eutectic Assembly	Pb-Free Assembly
Preheat & Soak		
Temperature min (T_{smin})	100 °C	150 °C
Temperature max (T_{smax})	150 °C	200 °C
Time (T_{smin} to T_{smax}) (t_s)	60-120 seconds	60-120 seconds
Average ramp-up rate (T_{smax} to T_p)	3 °C/second max.	3 °C/second max.
Liquidous temperature (T_L)	183 °C	217 °C
Time at liquidous (t_l)	60-150 seconds	60-150 seconds
Peak package body temperature (T_p)*	230 °C ~235 °C *	255 °C ~260 °C *
Classification temperature (T_c)	235 °C	260 °C
Time (t_p)** within 5 °C of the specified classification temperature (T_c)	20** seconds	30** seconds
Average ramp-down rate (T_p to T_{smax})	6 °C/second max.	6 °C/second max.
Time 25 °C to peak temperature	6 minutes max.	8 minutes max.
* Tolerance for peak profile temperature (T_p) is defined as a supplier minimum and a user maximum.		
** Tolerance for time at peak profile temperature (t_p) is defined as a supplier minimum and a user maximum.		

Tape & Reel Packaging:

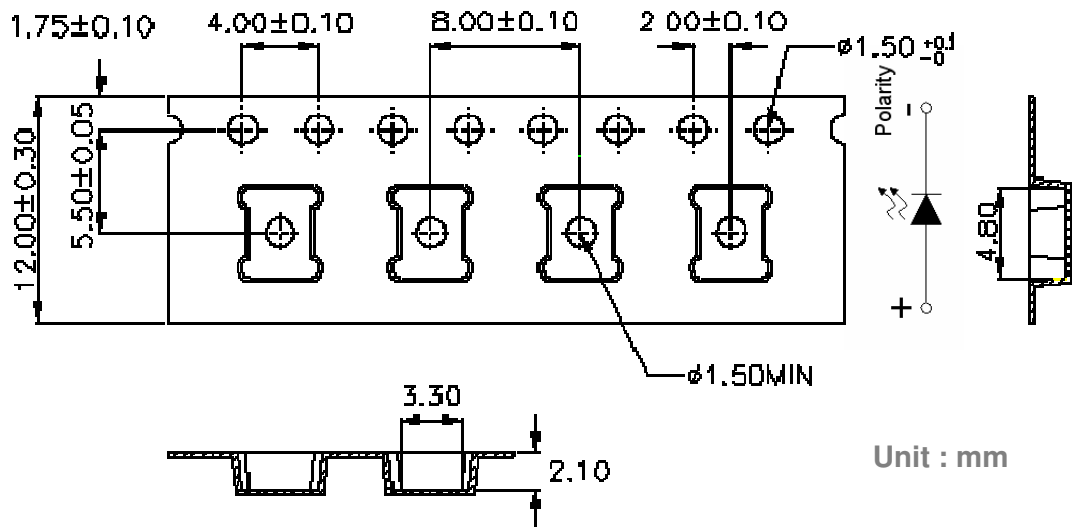
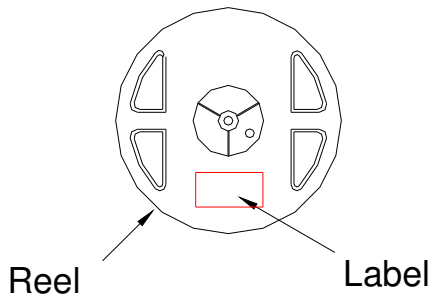
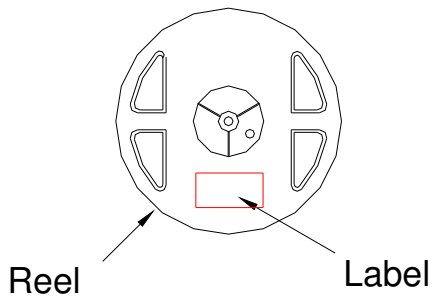

Figure 21: Federal Reel Dimensions.



Item	Quantity	Total	Dimensions(mm)
Reel	250pcs	250pcs	Diameter=178
Inner box	4 reels	1,000pcs	240*235*67
Outer box	5 inner boxes	5,000pcs	353*254*256



Item	Quantity	Total	Dimensions(mm)
Reel	1,000pcs	1,000pcs	Diameter=178
Inner box	5 reels	5,000pcs	240*235*67
Outer box	5 inner boxes	25,000pcs	353*254*256

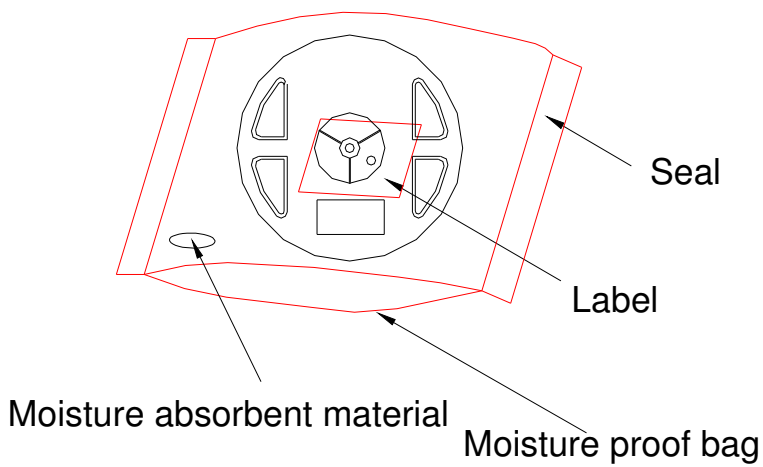

艾笛森光電股份有限公司 EDISON OPTO CORPORATION	
Part No : <u> XX </u>	Inspected By:
Group : <u> XX </u>	
Color : <u> XX </u>	
LOT NO. : <u> XX </u>	
Quantity : <u> XX </u>	
A321000204 TEL:886-2-82276996 FAX:886-2-82276997 4F, No.800, Chung-Cheng Rd., Chung-Ho City, Taipei, Taiwan.	

Package Label

Edixeon® Federal Bin Groups

Photometric Luminous Flux Bins for Cool White, Neutral White and Warm White

Table 12.

Group	Min. (lm)	Max. (lm)	Group	Min. (lm)	Max. (lm)
A	0.1	1.0	R	39.4	51.2
B	1.0	1.3	S1	51.2	58.8
C	1.3	1.7	S2	58.8	66.5
D	1.7	2.2	T1	66.5	70.0
E	2.2	2.9	T2	70.0	80.0
F	2.9	3.7	T3	80.0	86.5
G	3.7	4.8	U1	86.5	90
H	4.8	6.3	U2	90	100
J	6.3	8.2	U3	100	112.5
K	8.2	10.6	V	112.5	146.2
L	10.6	13.8	W	146.2	190.0
M	13.8	17.9	X	190.0	247.1
N	17.9	23.3	Y	247.1	321.2
P	23.3	30.3	Z	321.2	417.5
Q	30.3	39.4			

Photometric Luminous Flux Bins for Single Colors

Table 13.

Group	Min. (lm)	Max. (lm)	Group	Min. (lm)	Max. (lm)
A	0.1	1.0	N	17.9	23.3
B	1.0	1.3	P	23.3	30.3
C	1.3	1.7	Q	30.3	39.4
D	1.7	2.2	R	39.4	51.2
E	2.2	2.9	S	51.2	66.5
F	2.9	3.7	T	66.5	86.5
G	3.7	4.8	U	86.5	112.5
H	4.8	6.3	V	112.5	146.2
J	6.3	8.2	W	146.2	190.0
K	8.2	10.6	X	190.0	247.1
L	10.6	13.8	Y	247.1	321.2
M	13.8	17.9	Z	321.2	417.5

Radiometric Power Bins (mW)

Table 14.

Group	Min.	Max.	Group	Min.	Max.
A	10.0	15.0	K	384.4	576.7
B	15.0	22.5	L	576.7	865.0
C	22.5	33.8	M	865.0	1,298
D	33.8	50.6	N	1,298	1,946
E	50.6	75.9	P	1,946	2,919
F	75.9	113.9	Q	2,919	4,379
G	113.9	170.9	R	4,379	6,569
H	170.9	256.3	S	6,569	9,853
J	256.3	384.4	T	9,853	14,779

Cool White X,Y Groups

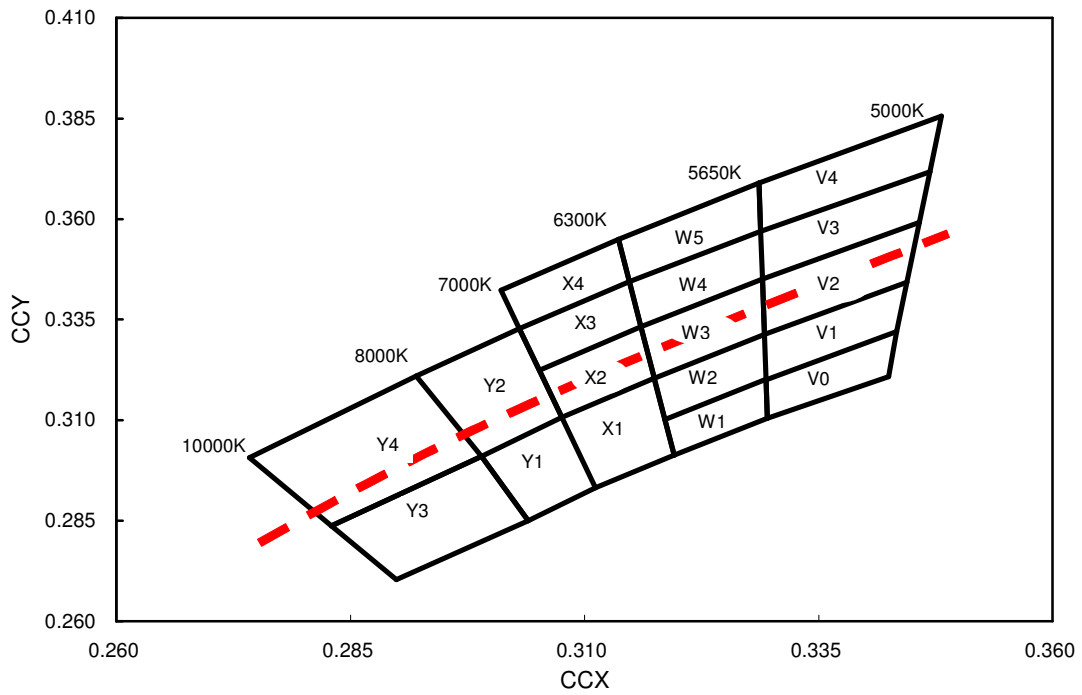

Figure 22: Cool White bin structure. The red line represents the blackbody locus on CIE 1931 graph.

Note:

Edison maintains a tolerance of ± 0.005 on x, y color coordinates.

Cool White Edixon® Federal X, Y Coordinates

Table 15.

Group/ CCT(Typ)	X	Y	Group/ CCT(Typ)	X	Y	Group/ CCT(Typ)	X	Y	Group/ CCT(Typ)	X	Y
V0 5300K	0.34335	0.33203	W1 6000K	0.32939	0.32021	X1 6650K	0.30755	0.31078	Y1 7500K	0.30400	0.28500
	0.34250	0.32080		0.32954	0.31050		0.31745	0.32044		0.29900	0.30100
	0.32954	0.31050		0.31960	0.30130		0.31960	0.30130		0.30755	0.31078
	0.32939	0.32002		0.31861	0.31020		0.31116	0.29319		0.31116	0.29319
V1 5300K	0.32922	0.33133	W2 6000K	0.32922	0.33133	X2 6650K	0.30755	0.31078	Y2 7500K	0.29900	0.30100
	0.34444	0.34423		0.32939	0.32021		0.30517	0.32239		0.29200	0.32100
	0.34335	0.33203		0.31861	0.31020		0.31604	0.33322		0.30305	0.33271
	0.32939	0.32002		0.31747	0.32044		0.31747	0.32044		0.30755	0.31078
V2 5300K	0.32922	0.33133	W3 6000K	0.32901	0.34509	X3 6650K	0.30517	0.32239	Y3 9000K	0.30400	0.28500
	0.32901	0.34509		0.32922	0.33133		0.30305	0.33271		0.28992	0.27032
	0.34578	0.35919		0.31747	0.32044		0.31479	0.34444		0.28297	0.28377
	0.34444	0.34423		0.31604	0.33322		0.31604	0.33322		0.29900	0.30100
V3 5300K	0.32901	0.34509	W4 6000K	0.32901	0.34509	X4 6650K	0.30305	0.33271	Y4 9000K	0.29200	0.32100
	0.32882	0.35692		0.31604	0.33322		0.30109	0.34224		0.27424	0.30067
	0.34690	0.37174		0.31479	0.34444		0.31362	0.35499		0.28297	0.28377
	0.34578	0.35919		0.32882	0.35692		0.31479	0.34444		0.29900	0.30100
V4 5300K	0.32882	0.35692	W5 6000K	0.31479	0.34444						
	0.32864	0.36895		0.31362	0.35499						
	0.34815	0.38563		0.32864	0.36895						
	0.34690	0.37174		0.32882	0.35692						

Neutral White X,Y Groups

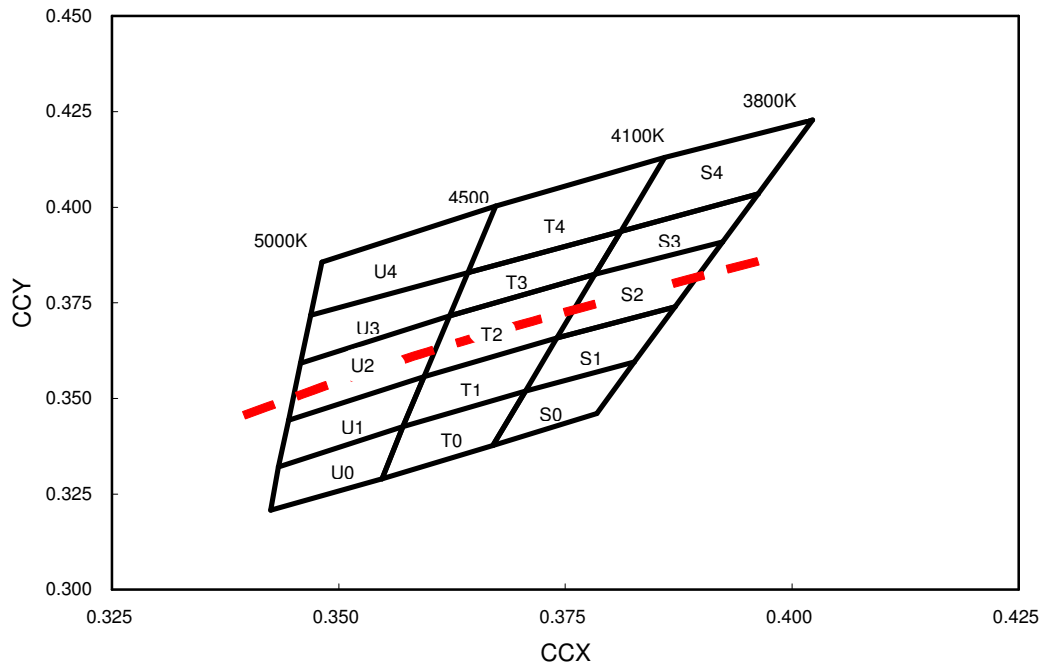

Figure 23: Neutral White bin structure. The red line represents the blackbody locus on CIE 1931 graph.

Note:

Edison maintains a tolerance of ± 0.005 on x, y color coordinates.

Neutral White Edixeon® Federal X, Y Coordinates

Table 16.

Group/ CCT(Typ)	X	Y	Group/ CCT(Typ)	X	Y	Group/ CCT(Typ)	X	Y
S0 3900K	0.382598	0.359515	T0 4300K	0.370582	0.351953	U0 4750K	0.357079	0.342581
	0.378500	0.346000		0.367000	0.337700		0.354800	0.329000
	0.367000	0.337700		0.354800	0.329000		0.342500	0.320800
	0.370582	0.351953		0.357079	0.342581		0.343352	0.332034
S1 3900K	0.374075	0.365822	T1 4300K	0.359401	0.355699	U1 4750K	0.344443	0.344232
	0.387071	0.373899		0.357079	0.342581		0.343352	0.332034
	0.382598	0.359515		0.370582	0.351953		0.357079	0.342581
	0.370582	0.351953		0.374075	0.365822		0.359401	0.355699
S2 3900K	0.378264	0.382458	T2 4300K	0.362219	0.371616	U2 4750K	0.362219	0.371616
	0.392368	0.390932		0.378264	0.382458		0.359401	0.355699
	0.387071	0.373899		0.374075	0.365822		0.344443	0.344232
	0.374075	0.365822		0.359401	0.355699		0.345781	0.359190
S3 3900K	0.378264	0.382458	T3 4300K	0.364212	0.382878	U3 4750K	0.364212	0.382878
	0.381106	0.393747		0.381106	0.393747		0.362219	0.371616
	0.396279	0.403508		0.378264	0.382458		0.345781	0.359190
	0.392368	0.390932		0.362219	0.371616		0.346904	0.371742
S4 3900K	0.385953	0.412995	T4 4300K	0.367294	0.400290	U4 4750K	0.364212	0.382878
	0.402270	0.422776		0.385953	0.412995		0.367294	0.400290
	0.396279	0.403508		0.381106	0.393747		0.348147	0.385629
	0.381106	0.393747		0.364212	0.382878		0.346904	0.371742

Warm White X,Y Groups

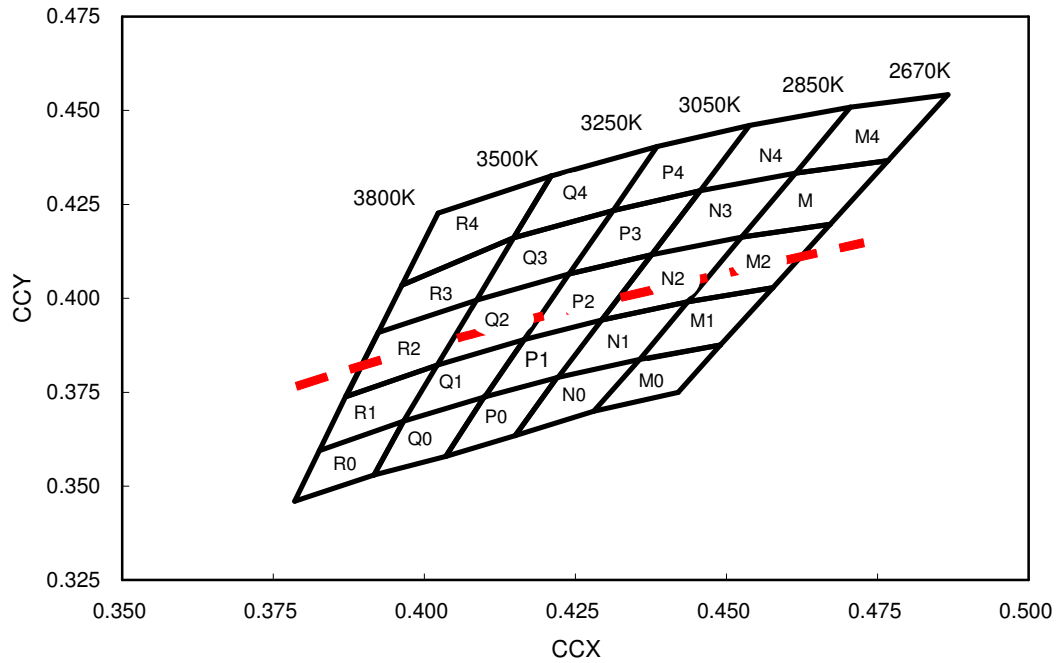

Figure 24: Warm White bin structure. The red line represents the blackbody locus on CIE 1931 graph.

Note:

Edison maintains a tolerance of ± 0.005 on x, y color coordinates.

Warm White Edixeon® Federal X, Y Coordinates

Table 17.

Group/ CCT(Typ)	X	Y	Group/ CCT(Typ)	X	Y	Group/ CCT(Typ)	X	Y
M0	0.43700	0.38400	N0	0.43559	0.38371	P0	0.42200	0.37900
	0.44899	0.38752		0.42800	0.37000		0.41500	0.36350
2700K	0.44200	0.37500	2900K	0.41500	0.36350	3150K	0.40350	0.35800
	0.42800	0.37000		0.42200	0.37900		0.41000	0.37400
M1	0.44360	0.39911	N1	0.42937	0.39428	P1	0.42937	0.39428
	0.45766	0.40287		0.44360	0.39911		0.42212	0.37895
2700K	0.44899	0.38752	2900K	0.43559	0.38371	3150K	0.41000	0.37381
	0.43559	0.38371		0.42212	0.37895		0.41649	0.38900
M2	0.45251	0.41624	N2	0.43758	0.41163	P2	0.42396	0.40647
	0.46713	0.41963		0.42937	0.39428		0.43758	0.41163
2700K	0.45766	0.40287	2900K	0.44360	0.39911	3150K	0.42937	0.39428
	0.44360	0.39911		0.45251	0.41624		0.41649	0.38900
M3	0.46140	0.43333	N3	0.46140	0.43333	P3	0.43119	0.42339
	0.47673	0.43663		0.45251	0.41624		0.44564	0.42868
2700K	0.46713	0.41963	2900K	0.43758	0.41163	3150K	0.43758	0.41163
	0.45251	0.41624		0.44564	0.42868		0.42396	0.40647
M4	0.47051	0.45083	N4	0.45382	0.44598	P4	0.43846	0.44040
	0.48665	0.45419		0.47051	0.45083		0.45382	0.44598
2700K	0.47673	0.43663	2900K	0.46140	0.43333	3150K	0.44564	0.42868
	0.46140	0.43333		0.44564	0.42868		0.43119	0.42339

**Forward Voltage Bins for White, True Green, Blue, Dental Blue, Royal Blue,
Cyan and Ultraviolet**

Table 18.

$V_F (V)$	
V 0 1	2.8 — 3.1
V 0 2	3.1 — 3.4
V 0 3	3.4 — 3.7
V 0 4	3.7 — 4.0
V 0 5	4.0 — 4.3
V 0 6	4.3 — 4.6
V 0 7	4.6 — 4.9
V 0 8	4.9 — 5.2

Forward Voltage Bins for Red, Amber, Deep Red and Cherry Red

Table 19.

$V_F (V)$	
V 0 1	2.0 — 2.25
V 0 2	2.25 — 2.5
V 0 3	2.5 — 2.75
V 0 4	2.75 — 3.0
V 0 5	3.0 — 3.25

Dominant/Peak Wavelength Bin Structure

Group	$\lambda_d(\text{nm}), \lambda_p(\text{nm})$
<i>Ultraviolet^[1]</i>	395 — 410
<i>W</i>	395 — 400
<i>X</i>	400 — 405
<i>Y</i>	405 — 410
<i>Royal Blue^[1]</i>	440 — 460
<i>V</i>	440 — 445
<i>W</i>	445 — 450
<i>X</i>	450 — 455
<i>Y</i>	455 — 460
<i>Dental Blue^[1]</i>	450 — 470
<i>W</i>	450 — 455
<i>X</i>	455 — 460
<i>Y</i>	460 — 465
<i>Z</i>	465 — 470
<i>Blue</i>	460 — 475
<i>W</i>	460 — 465
<i>X</i>	465 — 470
<i>Y</i>	470 — 475
<i>True Green</i>	515 — 535
<i>V</i>	515 — 520
<i>W</i>	520 — 525
<i>X</i>	525 — 530
<i>Y</i>	530 — 535
<i>Amber</i>	585 — 595
<i>X</i>	585 — 588
<i>Y</i>	588 — 591
<i>Z</i>	591 — 595
<i>Red</i>	620 — 630
<i>X</i>	620 — 630
<i>Deep Red</i>	650 — 670
<i>Cherry Red</i>	730 — 750

Notes:

1. Wavelengths are stated as peak wavelength.

Dominant Wavelength and CIE Coordinate

Table 20.

	Royal Blue	Wavelength/nm @ 350 mA			CIE color coordinates		
		Min. λ_p	Max. λ_p	Avg. λ_p	saturation	average x	average y
	<i>Royal Blue W</i>	440	445	442.5	99.6%	0.1645	0.0114
	<i>Royal Blue X</i>	445	450	447.5	99.6%	0.1597	0.0169
	<i>Royal Blue Y</i>	450	455	452.5	99.2%	0.1554	0.0226
<i>Royal Blue Z</i>	455	460	457.5	98.7%	0.1500	0.0299	
	Blue	Wavelength/nm @ 350 mA			CIE color coordinates		
		Min. λ_d	Max. λ_d	Avg. λ_d	saturation	average x	average y
	<i>Blue W</i>	460	465	462.5	98.2%	0.1434	0.0396
	<i>Blue X</i>	465	470	467.5	96.8%	0.1367	0.0568
	<i>Blue Y</i>	470	475	472.5	95.8%	0.1263	0.0817
	Green	Wavelength/nm @ 350 mA			CIE color coordinates		
		Min. λ_d	Max. λ_d	Avg. λ_d	saturation	average x	average y
	<i>Green V</i>	515	520	517.5	73.0%	0.1307	0.6939
	<i>Green W</i>	520	525	522.5	75.0%	0.1538	0.7077
	<i>Green X</i>	525	530	527.5	80.0%	0.1744	0.7201
<i>Green Y</i>	530	535	532.5	83.5%	0.2003	0.7181	
	Amber	Wavelength/nm @ 350 mA			CIE color coordinates		
		Min. λ_d	Max. λ_d	Avg. λ_d	saturation	average x	average y
	<i>Amber X</i>	585	588	586.5	99.3%	0.5480	0.4490
	<i>Amber Y</i>	588	591	589.5	99.3%	0.5631	0.4339
<i>Amber Z</i>	591	595	593.0	99.6%	0.5785	0.4195	
	Red	Wavelength/nm @ 350 mA			CIE color coordinates		
		Min. λ_d	Max. λ_d	Avg. λ_d	saturation	average x	average y
<i>Red</i>	620	630	625	99.8%	0.7011	0.2982	