

Low capacitance Transil™ arrays for ESD protection

Features

- 2 to 4 unidirectional Transil functions
- Breakdown voltage $V_{BR} = 6.1 \text{ V min.}$
- Low leakage current $< 100 \text{ nA}$
- Low capacitance ($7.5 \text{ pF @ } 3 \text{ V}$)
- Very small PCB area $< 2.6 \text{ mm}^2$

Benefits

- High ESD protection level
- High integration

Complies with the following standards

- IEC 61000-4-2 level 4
 - 15 kV (air discharge)
 - 8 kV (contact discharge)
- MIL STD 883E-Method 3015-7: class3
 - 25 kV HBM (human body model)

Applications

Where transient overvoltage protection in ESD sensitive equipment is required, such as:

- Computers
- Printers
- Communication systems
- Cellular phone handsets and accessories
- Wireline and wireless telephone sets
- Set-top boxes

Description

The ESDALC6V1Px are monolithic suppressors designed to protect components connected to data and transmission lines against ESD.

These devices clamp the voltage just above the logic level supply for positive transients and to a diode drop below ground for negative transients.

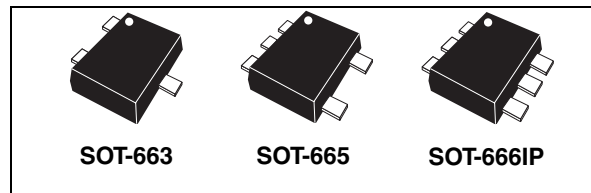

Figure 1. ESDALC6V1P3 functional diagram

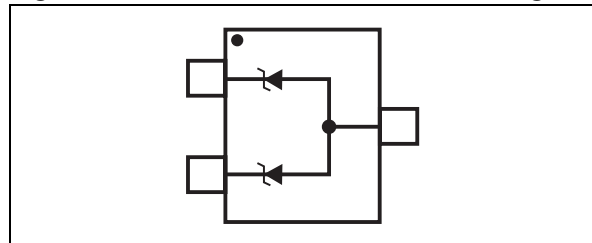

Figure 2. ESDALC6V1P5 functional diagram

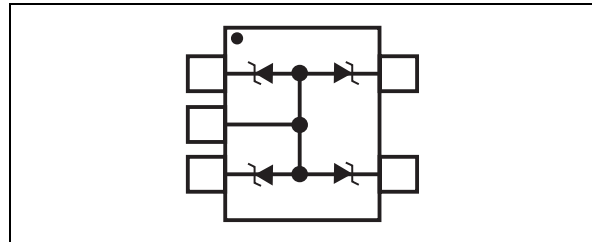
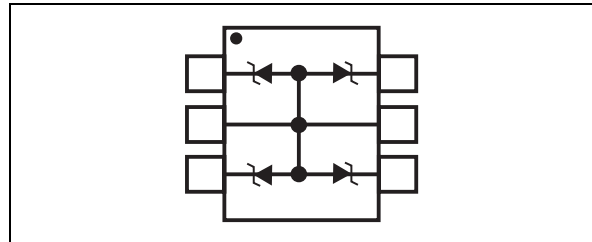

Figure 3. ESDALC6V1P6 functional diagram



TM: Transil is a trademark of STMicroelectronics

1 Characteristics

Table 1. Absolute ratings ($T_{amb} = 25\text{ °C}$)

Symbol	Parameter		Value	Unit
$V_{PP}^{(1)}$	Peak pulse voltage	IEC 61000-4-2 contact discharge IEC 61000-4-2 air discharge	± 8 ± 15	kV
P_{PP}	Peak pulse power (8/20 μs) ⁽¹⁾	T_j initial = T_{amb}	30	W
T_j	Junction temperature		150	$^{\circ}C$
T_{stg}	Storage temperature range		-55 to +150	$^{\circ}C$
T_L	Maximum lead temperature for soldering during 10 s		260	$^{\circ}C$
T_{op}	Operating temperature range		-40 to +150	$^{\circ}C$

1. For a surge greater than the maximum values, the diode will fail in short-circuit.

Figure 4. Electrical characteristics (definitions)

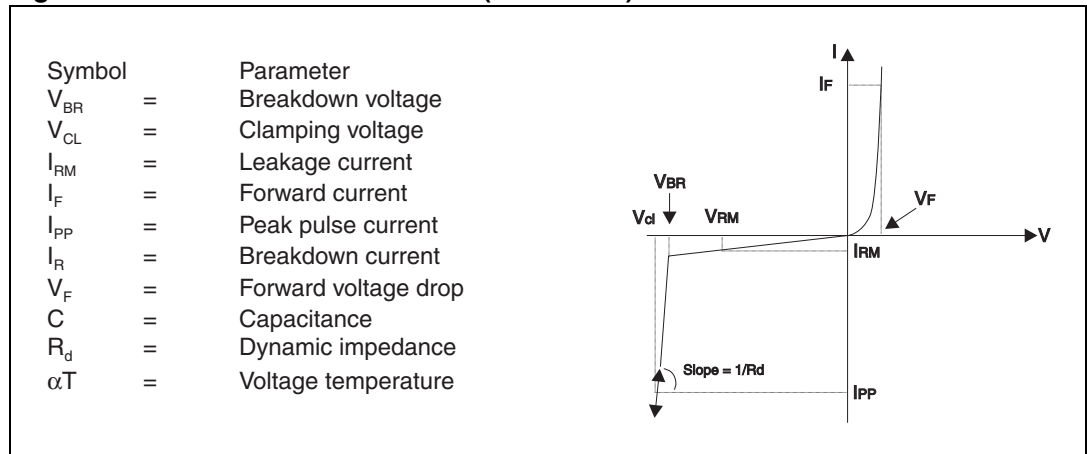

Table 2. Electrical characteristics ($T_{amb} = 25\text{ °C}$)

Order code	$V_{BR} @ I_R$			$I_{RM} @ V_{RM}$			R_d	αT	C
	min.	max.		typ.	max.		typ.	typ.	typ. @ 3V
	V	V	mA	nA	μA	V	Ω	$10^{-4}/^{\circ}C$	pF
ESDALC6V1P3 ESDALC6V1P5 ESDALC6V1P6	6.1	7.2	1	10	0.1	3	1.5	4.5	7.5

Figure 5. Peak power dissipation versus initial junction temperature

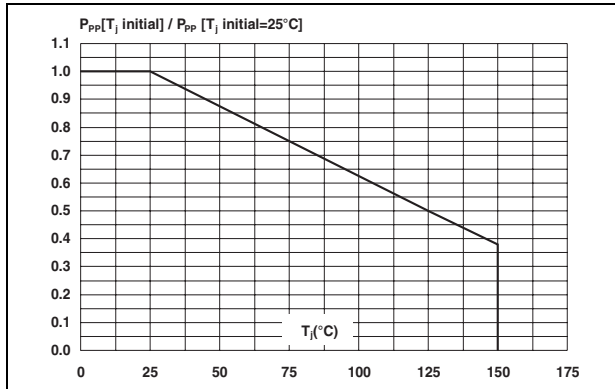

Figure 6. Peak pulse power versus exponential pulse duration (T_j initial = 25 °C)

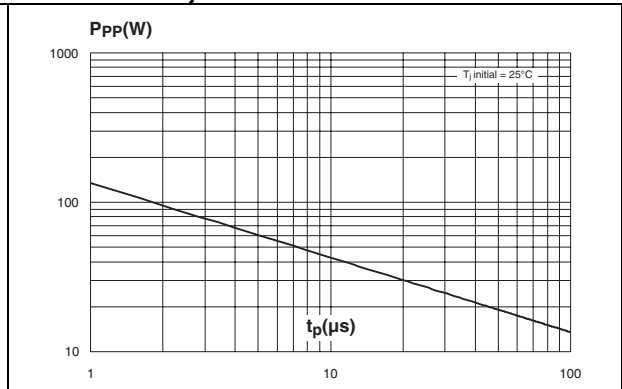

Figure 7. Clamping voltage versus peak pulse current (typical values, rectangular waveform)

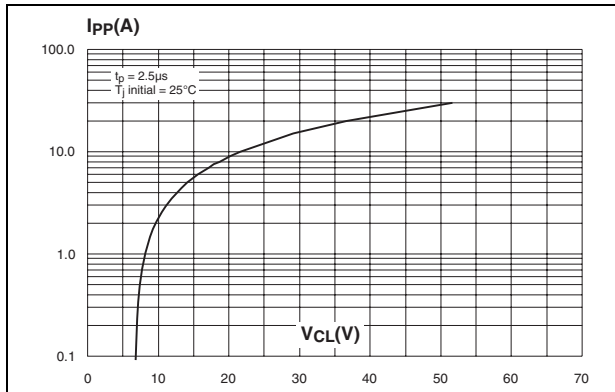

Figure 8. Forward voltage drop versus peak forward current (typical values)

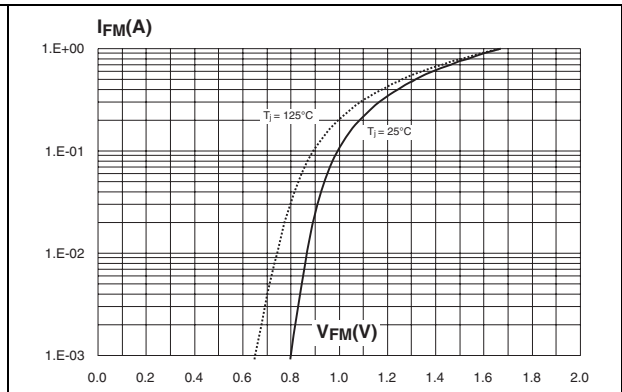

Figure 9. Junction capacitance versus reverse applied voltage (typical values)

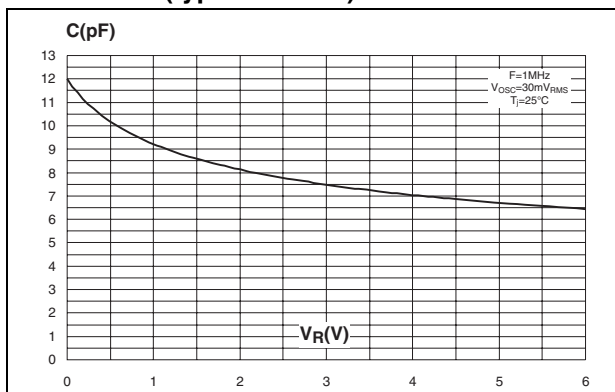

Figure 10. Relative variation of leakage current versus junction temperature (typical values)

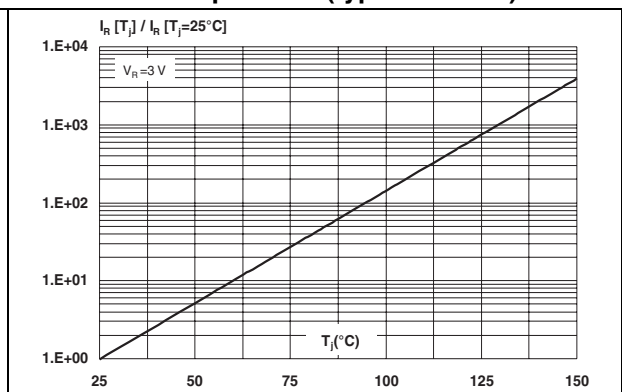

Figure 11. ESD response to IEC 61000-4-2 (air discharge 15 kV positive surge)

Figure 12. Analog crosstalk measurement

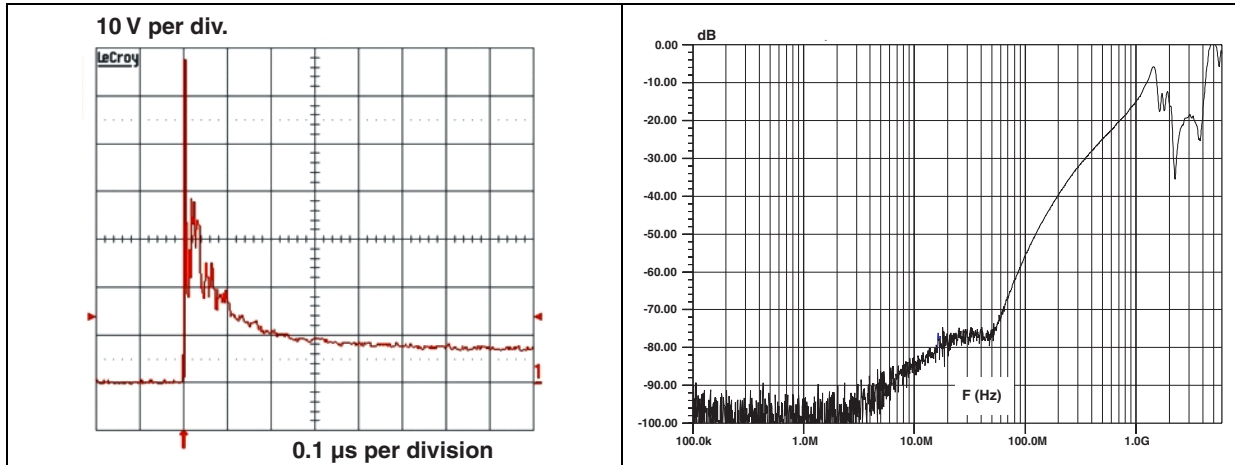
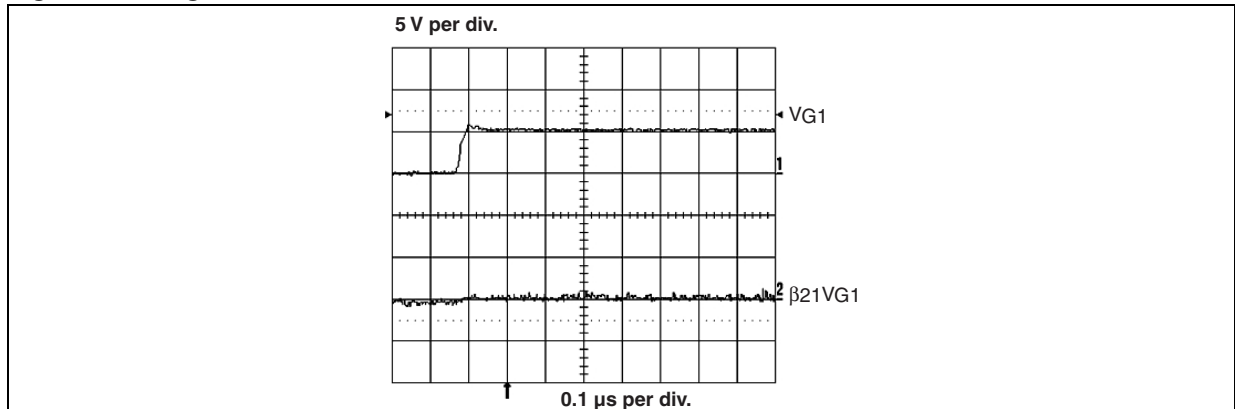
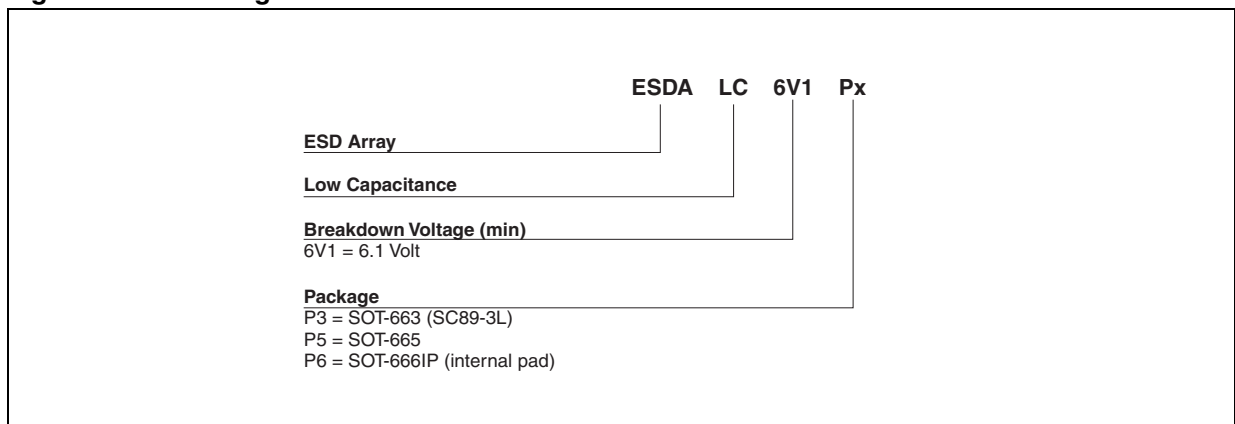

Figure 13. Digital crosstalk test measurement



2 Ordering information scheme

Figure 14. Ordering information scheme



3 Package information

- Epoxy meets UL94, V0
- Lead-free package

In order to meet environmental requirements, ST offers these devices in different grades of ECOPACK® packages, depending on their level of environmental compliance. ECOPACK® specifications, grade definitions and product status are available at: www.st.com. ECOPACK® is an ST trademark.

Table 3. SOT-663 dimensions

Ref.	Dimensions					
	Millimeters			Inches		
	Min.	Typ.	Max.	Min.	Typ.	Max.
A	0.60	0.70	0.80	0.024	0.028	0.031
D	1.40	1.60	1.80	0.055	0.063	0.071
E	0.75	0.85	0.95	0.030	0.033	0.037
HE	1.50	1.60	1.70	0.059	0.063	0.067
L		0.39			0.015	
L2	0.40	0.47	0.50	0.016	0.018	0.020
c	0.08	0.13	0.18	0.003	0.005	0.007
b	0.22	0.27	0.37	0.009	0.011	0.015
e		0.50			0.020	
2xe	0.90	1.00	1.10	0.035	0.040	0.043
α	4°		7°	4°		7°

Figure 15. SOT-663 footprint (dimensions in mm)

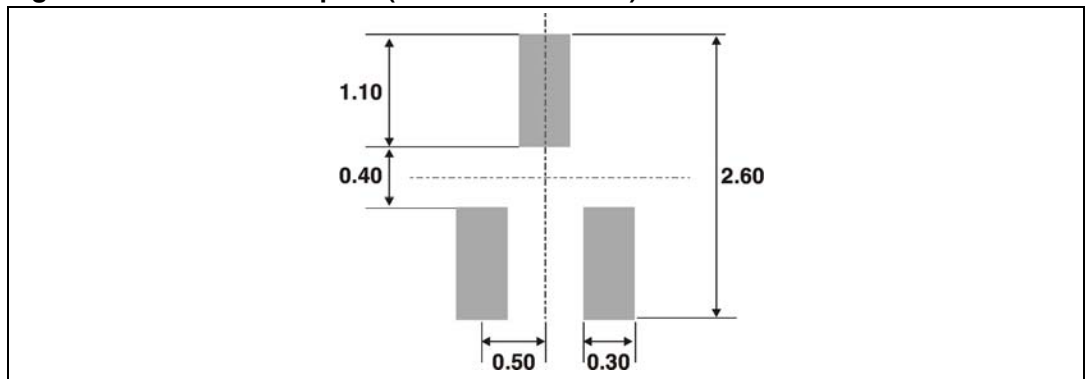

Table 4. SOT-665 dimensions

Ref.	Dimensions			
	Millimeters		Inches	
	Min.	Max.	Min.	Max.
A	0.50	0.60	0.020	0.024
BP	0.17	0.27	0.007	0.011
C	0.08	0.18	0.003	0.007
D	1.50	1.70	0.060	0.067
E	1.10	1.30	0.043	0.051
e	1.00		0.040	
e1	0.50		0.020	
He	1.50	1.70	0.059	0.067
Lp	0.10	0.30	0.004	0.012

Figure 16. SOT-665 footprint (dimensions in mm)

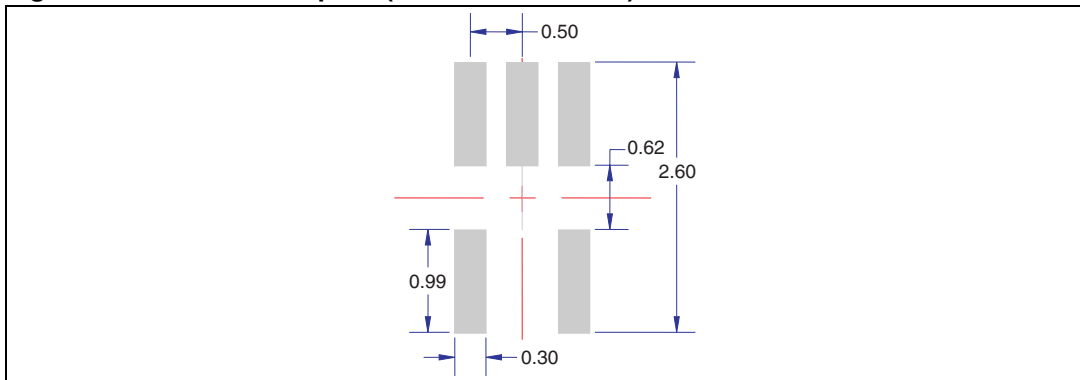
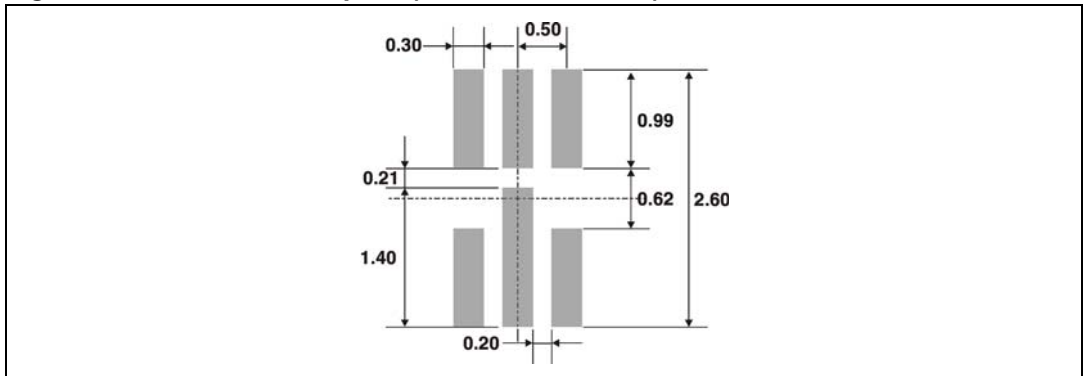

Table 5. SOT-666IP dimensions

Ref.	Dimensions					
	Millimeters			Inches		
	Min.	Typ.	Max.	Min.	Typ.	Max.
A	0.45		0.60	0.018		0.024
A3	0.08		0.18	0.003		0.007
b	0.17		0.34	0.007		0.013
b1	0.19	0.27	0.34	0.007	0.011	0.013
D	1.50		1.70	0.059		0.067
E	1.50		1.70	0.059		0.067
E1	1.10		1.30	0.043		0.051
e		0.50			0.020	
L1		0.19			0.007	
L2	0.10		0.30	0.004		0.012
L3		0.10			0.004	
L4		0.60			0.024	

Figure 17. SOT-666IP footprint (dimensions in mm)



4 Ordering information

Table 6. Ordering information

Order code	Marking	Package	Weight	Base qty	Delivery mode
ESDALC6V1P3	A2	SOT-663	2.9 mg	3000	Tape and reel
ESDALC6V1P5	A1	SOT-665	2.9 mg	3000	Tape and reel
ESDALC6V1P6	D	SOT-666IP	2.9 mg	3000	Tape and reel

5 Revision history

Table 7. Document revision history

Date	Revision	Changes
16-Aug-2006	1	ESDALC6V1P3, ESDALC6V1P5, and ESDALC6V1P6 merged and reformatted to current standards.
23-Aug-2006	2	Table 1 on page 2: Temperature range upgraded to $T_j \text{ max} = 150 \text{ }^\circ\text{C}$
11-Oct-2006	3	Added values for V_{PP} in Table 1.
23-Apr-2008	4	Reformatted to current standards. Added I_{RM} typical value in Table 2 . Update minimum dimension for L2 of SOT-663 in Table 3 .
15-Jan-2010	5	Updated Figure 16: SOT-665 footprint (dimensions in mm) .

Please Read Carefully:

Information in this document is provided solely in connection with ST products. STMicroelectronics NV and its subsidiaries ("ST") reserve the right to make changes, corrections, modifications or improvements, to this document, and the products and services described herein at any time, without notice.

All ST products are sold pursuant to ST's terms and conditions of sale.

Purchasers are solely responsible for the choice, selection and use of the ST products and services described herein, and ST assumes no liability whatsoever relating to the choice, selection or use of the ST products and services described herein.

No license, express or implied, by estoppel or otherwise, to any intellectual property rights is granted under this document. If any part of this document refers to any third party products or services it shall not be deemed a license grant by ST for the use of such third party products or services, or any intellectual property contained therein or considered as a warranty covering the use in any manner whatsoever of such third party products or services or any intellectual property contained therein.

UNLESS OTHERWISE SET FORTH IN ST'S TERMS AND CONDITIONS OF SALE ST DISCLAIMS ANY EXPRESS OR IMPLIED WARRANTY WITH RESPECT TO THE USE AND/OR SALE OF ST PRODUCTS INCLUDING WITHOUT LIMITATION IMPLIED WARRANTIES OF MERCHANTABILITY, FITNESS FOR A PARTICULAR PURPOSE (AND THEIR EQUIVALENTS UNDER THE LAWS OF ANY JURISDICTION), OR INFRINGEMENT OF ANY PATENT, COPYRIGHT OR OTHER INTELLECTUAL PROPERTY RIGHT.

UNLESS EXPRESSLY APPROVED IN WRITING BY AN AUTHORIZED ST REPRESENTATIVE, ST PRODUCTS ARE NOT RECOMMENDED, AUTHORIZED OR WARRANTED FOR USE IN MILITARY, AIR CRAFT, SPACE, LIFE SAVING, OR LIFE SUSTAINING APPLICATIONS, NOR IN PRODUCTS OR SYSTEMS WHERE FAILURE OR MALFUNCTION MAY RESULT IN PERSONAL INJURY, DEATH, OR SEVERE PROPERTY OR ENVIRONMENTAL DAMAGE. ST PRODUCTS WHICH ARE NOT SPECIFIED AS "AUTOMOTIVE GRADE" MAY ONLY BE USED IN AUTOMOTIVE APPLICATIONS AT USER'S OWN RISK.

Resale of ST products with provisions different from the statements and/or technical features set forth in this document shall immediately void any warranty granted by ST for the ST product or service described herein and shall not create or extend in any manner whatsoever, any liability of ST.

ST and the ST logo are trademarks or registered trademarks of ST in various countries.

Information in this document supersedes and replaces all information previously supplied.

The ST logo is a registered trademark of STMicroelectronics. All other names are the property of their respective owners.

© 2010 STMicroelectronics - All rights reserved

STMicroelectronics group of companies

Australia - Belgium - Brazil - Canada - China - Czech Republic - Finland - France - Germany - Hong Kong - India - Israel - Italy - Japan - Malaysia - Malta - Morocco - Philippines - Singapore - Spain - Sweden - Switzerland - United Kingdom - United States of America

www.st.com