

Features:

- 7.62x7.62x4.0mm 3.0 FLUX LED LAMP.
- ULTRA BRIGHTNESS.
- LOW POWER CONSUMPTION.
- WIDE VIEWING ANGLE.
- IDEAL FOR BACKLIGHT AND INDICATOR.

Part No.:

FYLF-1860URC
FYLF-1860UEC
FYLF-1860UYC
FYLF-1860UGC

Note:X = Len Color: C=Water Clear, D=Color Diffused, T=Color Trans

Description:

- Color Code & Chip characteristics: (Test Condition: IF=20mA)

Emitting Color		Dice Material	Peak Wave Length h(l p)	Spectral Line halfwidth(l 1/2)	Forward Voltage(VF) Unit:V		Luminous Intensity (Iv) Unit:ucd
					Typ	Max	
UR	Ultra Red	GaAlAs/GaAs,D DH	660nm	20nm	1.85	2.20	12000
UE	Ultra Orange	AlGaInP	630nm	20nm	2.10	2.50	7000
UY	Ultra Yellow	AlGaInP	590nm	20nm	2.10	2.50	7000
UG	Ultra Green	AlGaInP	574nm	30nm	2.20	2.50	5000

Electrical-optical characteristics: (Ta=25)

Parameter	Symbol	AlGaAs	GaAsP	AlGaInP	InGaN	Unit
Power Dissipation	P _{ad}	60	80	75	120	mW
Peak Forward Current *	I _{pf}	150	150	150	100	mA
Continuous Forward Current	I _{af}	25	30	30	30	mA

Notes:

- * Test Condition = Duty 0.1,10KHZ

Package configuration & Internal circuit diagram:

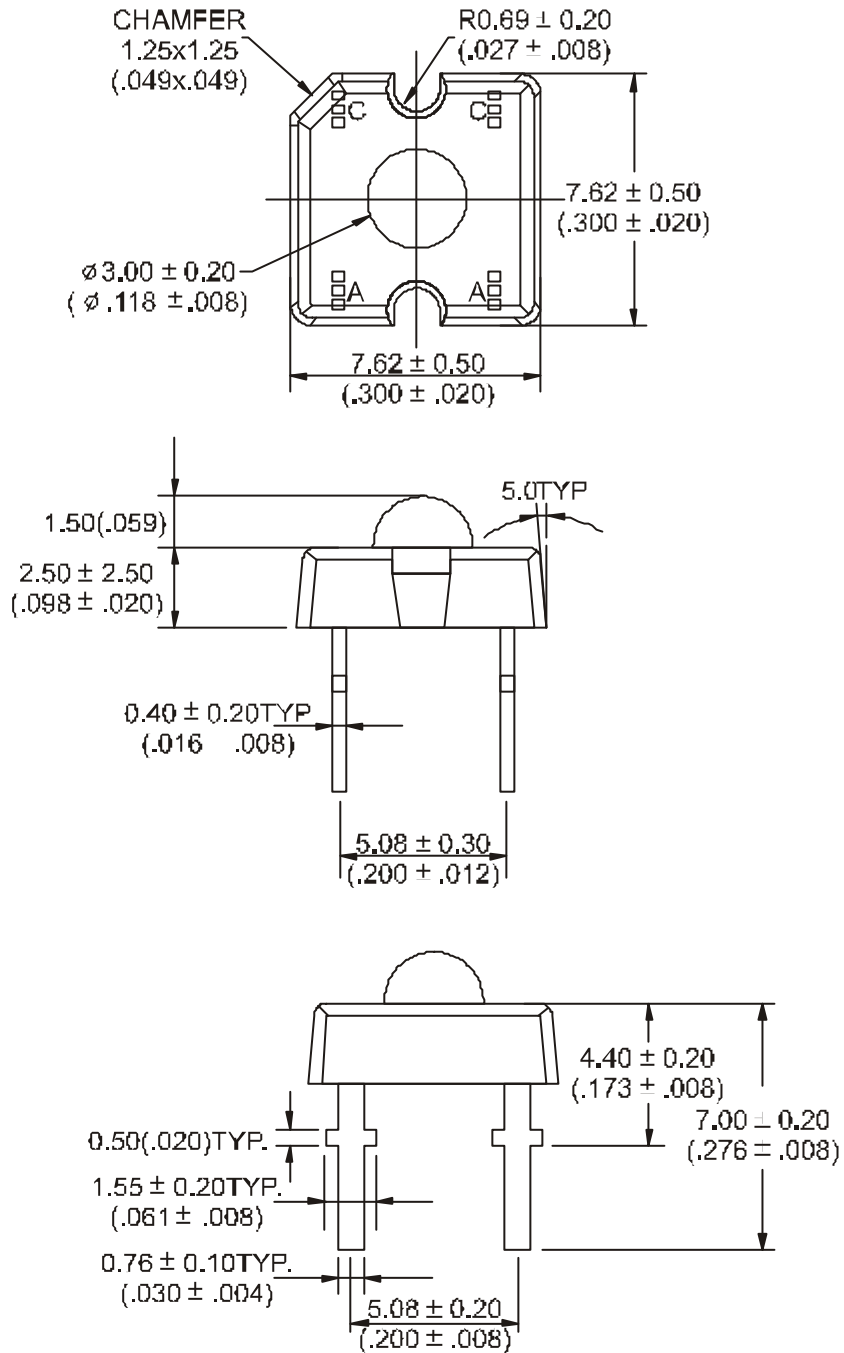
FYLF-1860xx

Notes:

- All dimensions are in millimeters (inches)
- Tolerance is $\pm 0.25(0.01)$ " unless otherwise noted.
- Specifications are subject to change without notice.

Absolute maximum ratings (Ta=25 °C)

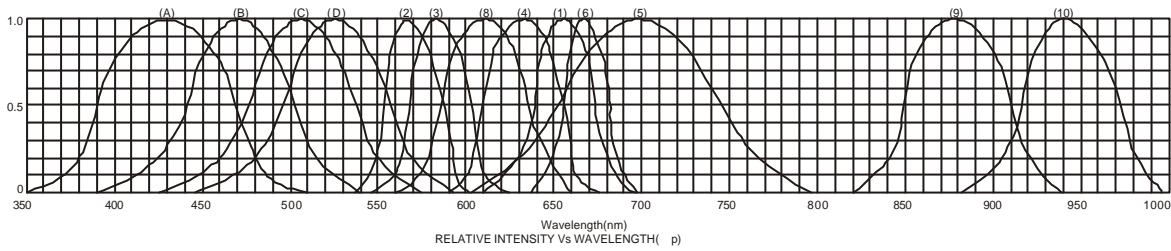
Reverse Voltage	5V
Reverse Current	20μA
Operating Temperature Range	-40 to+85
Storage Temperature Range	-40 to+85
Lead Solder Temperature (1.6mm(1/16")from body) 230	for 5 Seconds

Typical electrical-optical characteristics curves:

- | | |
|---|--------------------------------------|
| (1) - GaAsP/GaAs 655nm/Red | (9) - GaAlAs 880nm |
| (2) - GaP 570nm/Yellow Green | (10) - GaAs/GaAs & GaAlAs/GaAs 940nm |
| (3) - GaAsP/GaP 585nm/Yellow | (A) - GaN/SiC 430nm/Blue |
| (4) - GaAsP/GaP 635nm/Orange & Hi-Eff Red | (B) - InGaN/SiC 470nm/Blue |
| (5) - GaP 700nm/Bright Red | (C) - InGaN/SiC 505nm/Ultra Green |
| (6) - GaAlAs/GaAs 660nm/Super Red | (D) - InGaAl/SiC 525nm/Ultra Green |
| (8) - GaAsP/GaP 610nm/Super Red | |

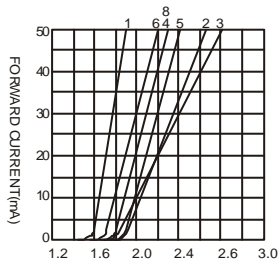

FORWARD VOLTAGE (Vf)
FORWARD CURRENT VS.
FORWARD VOLTAGE

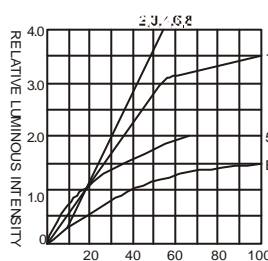

FORWARD CURRENT (mA)
RELATIVE LUMINOUS
INTENSITY VS. FORWARD
CURRENT

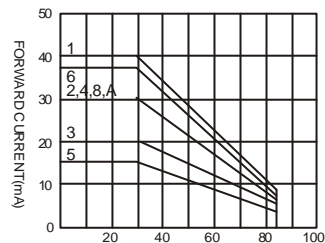

AMBIENT TEMPERATURE Ta(°C)
FORWARD CURRENT VS. AMBIENT
TEMPERATURE

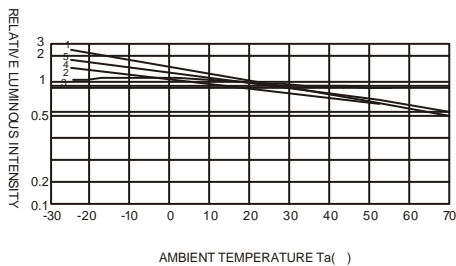

AMBIENT TEMPERATURE Ta(°C)

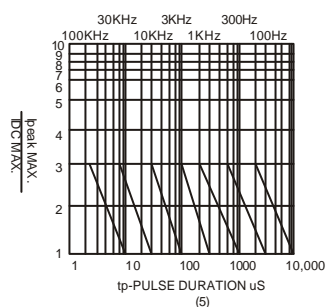
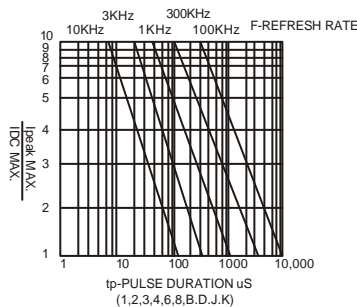

NOTE:25 °C free air temperature unless otherwise specified