

Ultracompact, Ultrasensitive DPDT Relay

- Compact size and low 5mm profile.
- Low power consumption (140 mW for single-side stable, 100 to 300 mW for latching type) and high sensitivity.
- Low thermoelectromotive force.
- Low magnetic interference enables high-density mounting.
- Single- and double-winding latching types also available.

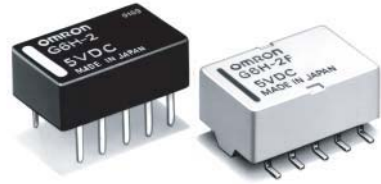

Ordering Information

Classification			Single-side stable	Single-winding latching	Double-winding latching
DPDT	Fully Sealed	PCB terminal	G6H-2	G6HU-2	G6HK-2
		Surface mount terminal	G6H-2F	—	—

Note: When ordering, add the rated coil voltage to the model number.

Example: G6HK-2 12 VDC

Rated coil voltage

Model Number Legend

G6H - - VDC
 1 2 3 4 5

1. Relay Function

- None: Single-side stable
- U: Single-winding latching
- K: Double-winding latching

2. Contact Form

- 2: DPDT
- #### 3. Terminal Shape
- None: PCB terminal
 - F: Surface mount terminal

4. Classification

- U: Ultrasonically cleanable

5. Rated Coil Voltage

- 3, 5, 6, 9, 12, 24 VDC

Specifications

■ Coil Ratings

Single-side Stable Type (G6H-2, G6H-2F)

Rated voltage	3 VDC	5 VDC	6 VDC	9 VDC	12 VDC	24 VDC
Rated current	46.7 mA	28.1 mA	23.3 mA	15.5 mA	11.7 mA	8.3 mA
Coil resistance	64.3 Ω	178 Ω	257 Ω	579 Ω	1,028 Ω	2,880 Ω
Coil inductance (H) (ref. value)	Armature OFF	0.025	0.065	0.11	0.24	0.43
	Armature ON	0.022	0.058	0.09	0.20	0.37
Must operate voltage	75% max. of rated voltage					
Must release voltage	10% min. of rated voltage					
Max. voltage	200% of rated voltage at 23°C					170% of rated voltage at 23°C
Power consumption	Approx. 140 mW					Approx. 200 mW

Note: 48 VDC (single-side stable) model is also available. Consult OMRON for details.

Single-winding Latching Type (G6HU-2)

Rated voltage	3 VDC	5 VDC	6 VDC	9 VDC	12 VDC	24 VDC
Rated current	33.3 mA	20 mA	16.7 mA	11.1 mA	8.3 mA	6.25 mA
Coil resistance	90 Ω	250 Ω	360 Ω	810 Ω	1,440 Ω	3,840 Ω
Coil inductance	Armature OFF	0.034	0.11	0.14	0.33	0.60
(H) (ref. value)	Armature ON	0.029	0.09	0.12	0.28	0.50
Must operate voltage	75% max. of rated voltage					
Must release voltage	75% min. of rated voltage					
Max. voltage	180% of rated voltage at 23°C					
Power consumption	Approx. 100 mW					Approx. 150 mW

Double-winding Latching Type (G6HK-2)

Rated voltage	3 VDC	5 VDC	6 VDC	9 VDC	12 VDC	24 VDC
Rated current	66.7 mA	40 mA	33.3 mA	22.2 mA	16.7 mA	12.5 mA
Coil resistance	45 Ω	125 Ω	180 Ω	405 Ω	720 Ω	1,920 Ω
Coil inductance	Armature OFF	0.014	0.042	0.065	0.16	0.3
(H) (ref. value)	Armature ON	0.0075	0.023	0.035	0.086	0.33
Must operate voltage	75% max. of rated voltage					
Must release voltage	75% min. of rated voltage					
Max. voltage	160% of rated voltage at 23°C					130% of rated voltage at 23°C
Power consumption	Approx. 200 mW					Approx. 300 mW

Note: 1. The rated current and coil resistance are measured at a coil temperature of 23°C with a tolerance of ±10%.

2. Operating characteristics are measured at a coil temperature of 23°C.

■ Contact Ratings

Load	Resistive load ($\cos\phi = 1$)
Rated load	0.5 A at 125 VAC; 1 A at 30 VDC
Contact material	Ag (Au-clad)
Rated carry current	1 A
Max. switching voltage	125 VAC, 110 VDC
Max. switching current	1 A
Max. switching power	62.5 VA, 33 W
Failure rate (reference value)	10 μA at 10 mVDC

Note: P level: $\lambda_{60} = 0.1 \times 10^{-6}$ /operation

■ Characteristics

Contact resistance	50 mΩ max. (G6H-2-U: 100 mΩ max.; G6H-2F: 60 mΩ max.)
Operate (set) time	Single-side stable types: 3 ms max. (mean value: approx. 2 ms) Latching types: 3 ms max. (mean value: approx. 1.5 ms)
Release (reset) time	Single-side stable types: 2 ms max. (mean value: approx. 1 ms) Latching types: 3 ms max. (mean value: approx. 1.5 ms)
Bounce time	Operate: Approx. 0.5 ms Release: Approx. 0.5 ms Set/reset: Approx. 0.5 ms
Min. set/reset signal width	Latching type: 5 ms min. (at 23°C)
Max. operating frequency	Mechanical: 36,000 operations/hr Electrical: 1,800 operations/hr (under rated load)
Insulation resistance	1,000 MΩ min. (at 500 VDC)
Dielectric withstand voltage	1,000 VAC, 50/60 Hz for 1 min between coil and contacts 1,000 VAC, 50/60 Hz for 1 min between contacts of different polarity 750 VAC, 50/60 Hz for 1 min between contacts of same polarity
Impulse withstand voltage	1,500 V (10 x 160 μs) between contacts of same polarity (conforms to FCC Part 68)
Vibration resistance	Destruction: 10 to 55 to 10 Hz, 2.5mm single amplitude (5mm double amplitude) Malfunction: 10 to 55 to 10 Hz, 1.65mm single amplitude (3mm double amplitude)
Shock resistance	Destruction: 1,000 m/s ² Malfunction: 500 m/s ²
Endurance	Mechanical: 100,000,000 operations min. (at 36,000 operations/hr) Electrical: 200,000 operations min. (at 1,800 operations/hr)
Ambient temperature	Operating: -40°C to 70°C (with no icing)
Ambient humidity	Operating: 5% to 85%
Weight	Approx. 1.5 g

■ Approved Standards

UL114, UL478 (File No. E41515)/CSA C22.2 No.0, No.14 (File No. LR31928)

Model	Contact form	Coil ratings	Contact ratings
G6H-2 G6HU-2 G6HK-2 G6H(U/K)-2-U G6H(U/K)-2-100	DPDT	1.5 to 48 VDC	2 A, 30 VDC 0.3 A, 110 VDC 0.5 A, 125 VAC

Engineering Data

Maximum Switching Power

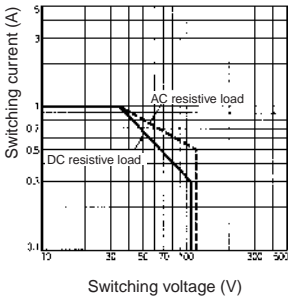

Endurance

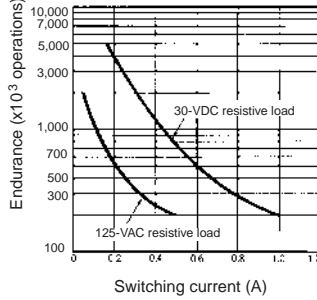

Ambient Temperature vs. Maximum Coil Voltage

Single-side Stable (G6H-2)

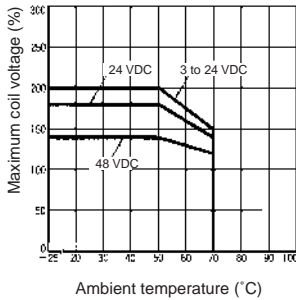

Single-winding Latching (G6HU-2)

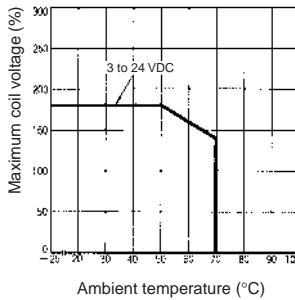

Double-winding Latching (G6HK-2)

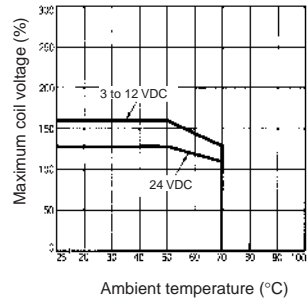

Note: The maximum coil voltage refers to the maximum value in a varying range of operating power voltage, not a continuous voltage.

Malfunctioning Shock Resistance (G6H-2)

5 VDC
Number of Units: 10

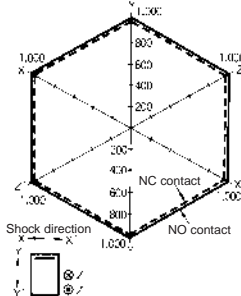

Condition: The Units were shocked at the rate of 500 m/s² three times each in the ±X, ±Y, and ±Z directions with and without voltage imposed on the Units until the Units malfunctioned.

High-frequency Characteristics

Frequency vs. Isolation

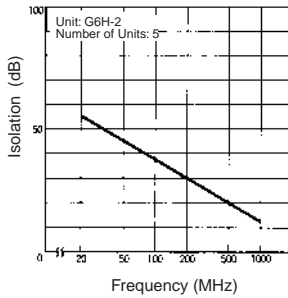

Frequency vs. Insertion Loss

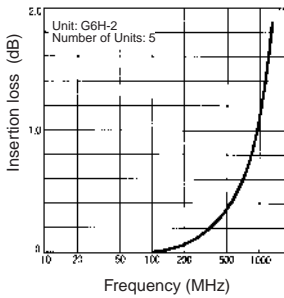

Frequency vs. Return Loss, V.SWR

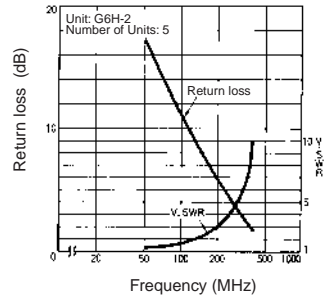

Note: The above characteristics were obtained from the Units inserted into test sockets. The characteristics of G6H-2 Units in actual operation may be different from the above characteristics. Check the characteristics of G6H-2 Units under the actual conditions before use.

Distribution of Operate and Release Time

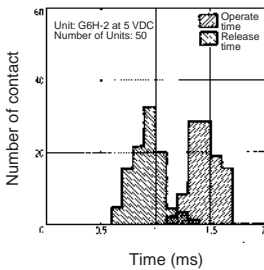

Distribution of Bounce Time

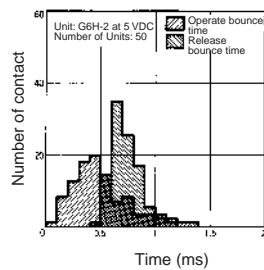

Dimensions

Note: 1. All units are in millimeters unless otherwise indicated.

2. Orientation marks are indicated as follows:

Single-side Stable Type

G6H-2(-U)

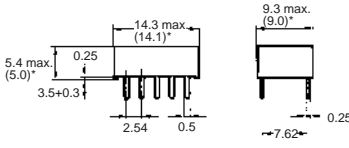
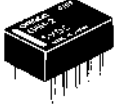

* Average value

Terminal Arrangement/ Internal Connections (Bottom View)

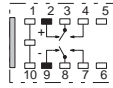

Mounting Holes (Bottom View)

Tolerance: ± 0.1

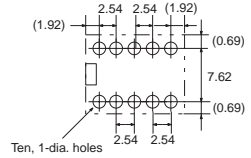

Single-winding Latching Type

G6HU-2(-U)

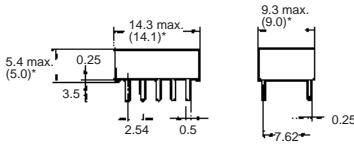
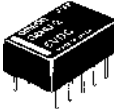

* Average value

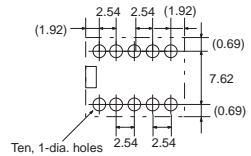
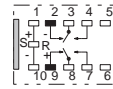

Double-winding Latching Type

G6HK-2(-U)

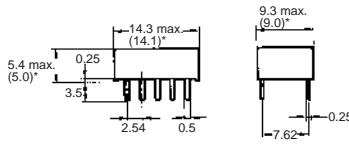
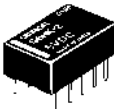

* Average value

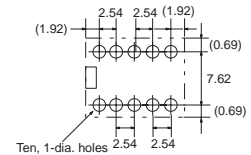
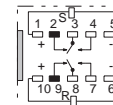

Single-side Stable Type

G6H-2F

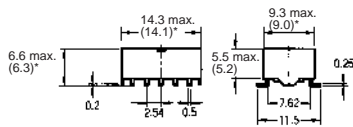
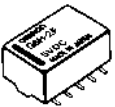

* Average value

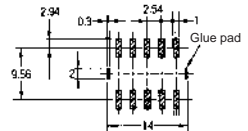
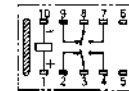

ALL DIMENSIONS SHOWN ARE IN MILLIMETERS.

To convert millimeters into inches, multiply by 0.03937. To convert grams into ounces, multiply by 0.03527.