

Genesys™

Programmable DC Power Supplies
750W/1500W in 1U
Built in RS-232 & RS-485 Interface
Advanced Parallel Operation

Optional Interface:
LXI Compliant LAN
IEEE488.2 SCPI (GPIB) Multi-drop
Isolated Analog Programming



TDK-Lambda

The Genesys™ family of programmable power supplies sets a new standard for flexible, reliable, AC/DC power systems in OEM, Industrial and Laboratory applications.

Features include:

- High Power Density: 1500W in 1U
 - Wide Range Input (85 - 265Vac Continuous, single phase, 47/63Hz)
 - Active Power Factor Correction (0.99 typical)
 - Output Voltage up to 600V, Current up to 200A
 - Built-in RS-232/RS-485 Interface Standard
 - Last-Setting Memory
 - Front Panel Lock selectable from Front Panel or Software
 - High Resolution 16 bit ADCs & DACs
 - Reliable Encoders for Voltage and Current Adjustment
 - Constant Voltage/Constant Current auto-crossover
 - Advanced Parallel reports total current up to four identical units
 - Global Commands for Serial RS-232/RS-485 Interface
 - Independent Remote ON/OFF and Remote Enable/Disable
 - External Analog Programming and Monitoring (user selectable 0-5V & 0-10V)
 - Reliable Modular and SMT Design
 - 19" Rack Mounted ATE and OEM applications
 - Optional Interfaces
 - Isolated Analog Programming and Monitoring Interface (0-5V/0-10V & 4-20mA)
 - IEEE 488.2 SCPI (GPIB) Multi-Drop
 - LXI** Compliant LAN
 - LabView® and LabWindows® drivers
 - Five Year Warranty
- Worldwide Safety Agency Approvals; CE Mark for LVD and EMC Regulation



Applications

Genesys™ power supplies have been designed to meet the demands of a wide variety of applications.

Test and Measurement

Last-Setting memory simplifies test design and requires no battery backup.

Built-in RS-232/RS-485 gives maximum system flexibility along with 0-5V and 0-10V, selectable analog programming.

Wide range of available inputs allows testing of many different devices.

Semiconductor Burn-in

Safe-Start may be ENABLED to re-start at Output OFF to protect load.

Wide range input (85-265Vac) with Active Power Factor correction rides through input transients easily.

Component Test

High power density, zero stacking and single wire parallel operation give maximum system flexibility.

Laser Diode

OVP is directly set on Voltage Display, assuring accurate protection settings.

Current Limit Fold Back assures load is protected from current surges.

Heater Supplies

Smooth, reliable encoders enhance front panel control.

Remote analog programming is user selectable 0-5V or 0-10V.

RF Amplifiers and Magnets

Robust design assures stable operation under a wide variety of loads.

High linearity in voltage and current mode.

Front Panel Description



1. AC ON/OFF Switch
2. Air Intake allows zero stacking for maximum system flexibility and power density.
3. Reliable encoder controls Output Voltage and sets Address.
4. Volt Display shows Output Voltage and directly displays OVP, UVL and Address settings.
5. Reliable encoder controls Output Current, sets baudrate and Advanced Parallel mode.
6. Current Display shows Output Current and displays baudrate.
7. Function/Status LEDs:
 - Alarm
 - Foldback Mode
 - Fine Control
 - Remote Mode
 - Preview Settings
 - Output On
8. Pushbuttons allow flexible user configuration
 - Coarse and Fine adjustment of Output Voltage/Current and Advanced Parallel Master or Slave
 - Preview settings and set Voltage/Current with Output OFF, Front Panel Lockout
 - Set OVP and UVL Limits
 - Set Current Foldback
 - Local/Remote Mode and select Address and Baudrate
 - Output ON/OFF and Auto-Start/Safe-Start Mode

Rear Panel Description



1. Remote/Local Output Voltage Sense Connections.
2. DIP Switches select 0-5V or 0-10V Programming and other functions.
3. DB25 (Female) connector allows (Non-isolated) Analog Program and Monitor and other functions.
4. RS-485 OUT to other Genesys™ Power Supplies.
5. RS-232/RS-485 IN Remote Serial Programming.
6. Output Connections: Rugged busbars for up to 60V Output; wire clamp connector for Outputs >60V.
7. Exit air assures reliable operation when zero stacked.
8. Wide-Range Input 85-265VAC continuous, 47/63Hz with Active Power Factor Correction (0.99 typical).
AC Input Connector: 750W (IEC320), 1500W (screw terminal-shown).
9. Optional Interface Position for IEEE 488.2 SCPI (shown) or Isolated Analog Interface or LAN Interface.

Genesys™ 750W/1500W Specifications

1.0 MODEL	GEN	6-200	8-180	12.5-120	20-76	30-50	40-38	50-30	60-25	80-19	100-15	150-10	300-5	600-2.6	750W	1500W
1. Rated output voltage(*1)	V	6	8	12.5	20	30	40	50	60	80	100	150	300	600		X
2. Rated Output Current(*2)	A	200	180	120	76	50	38	30	25	19	15	10	5	2.6		X
3. Rated Output Power	W	1200	1440	1500	1520	1500	1520	1500	1500	1520	1500	1500	1500	1560		X
4. Efficiency at 100/200Vac (*3)	%	77/79	78/81	81/84	83/86	83/86	84/88	84/88	84/88	84/88	84/88	84/88	84/88	84/88	X	X

1.0 MODEL	GEN	6-100	8-90	12.5-60	20-38	30-25	40-19	---	60-12.5	80-9.5	100-7.5	150-5	300-2.5	600-1.3	750W	1500W
1. Rated output voltage (*1)	V	6	8	12.5	20	30	40	---	60	80	100	150	300	600	X	X
2. Rated Output Current (*2)	A	100	90	60	38	25	19	---	12.5	9.5	7.5	5	2.5	1.3	X	X
3. Rated Output Power	W	600	720	750	760	750	760	---	750	760	750	750	750	780	X	X

1.1 CONSTANT VOLTAGE MODE

1. Max. line regulation (0.01% of Vo+ 2mV)(*4)	mV	2.6	2.8	3.3	4	5	6	7	8	10	12	17	32	62	X	X	
2. Max load regulation (0.01% of Vo+2mV)(*5)	mV	2.6	2.8	3.3	4	5	6	7	8	10	12	17	32	62	X	X	
3. Ripple and noise p-p 20MHz (*9)	mV	60	60	60	60	60	60	60	60	80	80	100	150	300	X	X	
4. Ripple r.m.s 5Hz-1MHz (*9)	mV	8	8	8	8	8	8	8	8	8	8	10	25	60	X	X	
5. Remote sense compensation/line	V	1	1	1	1	1.5	2	2	3	4	5	5	5	5	X	X	
6. Temp. coefficient	PPM/°C	100PPM/°C of rated output voltage, following 30 minutes warm up													X	X	
7. Up-prog. response time, 0-Vo Rated	mS	80mS , N.L./F.L , resistive load									150mS , N.L./F.L , resistive load				250	X	X
8. Down-prog response time full-load	mS	10	50	80										150	250	X	X
9. Down-prog response time no-load	mS	500	600	700	800	900	1000	1100	1100	1200	1500	2000	2500	4000	X	X	
10. Transient response time (*8)		Less than 1mSec for models up to and including 100V. 2msec for models above 100V													X	X	

1.2 CONSTANT CURRENT MODE

1. Max. line regulation (0.01% of Io+ 2mA)(*4)	mA	12	11	8.0	5.8	4.5	3.9	---	3.25	2.95	2.75	2.5	2.25	2.13	X	X
2. Max. load regulation (0.02% of Io+5mA)(*6)	mA	25	23	17	12.6	10	8.8	---	7.5	6.9	6.5	6.0	5.5	5.26	X	X
3. Ripple r.m.s 5Hz-1MHz .(*7)	mA	200	180	120	76	63	48	---	38	29	23	18	13	8	X	X
4. Max. line regulation (0.01% of Io+ 2mA)(*4)	mA	22	20	14	9.6	7.0	5.8	5	4.5	3.9	3.5	3.0	2.5	2.26		X
5. Max. load regulation (0.02% of Io+5mA)(*6)	mA	45	41	29	20.2	15	12.6	11	10	8.8	8.0	7.0	6.0	5.52		X
6. Ripple r.m.s 5Hz-1MHz .(*7)	mA	400	360	240	152	125	95	85	75	57	45	35	25	12		X
7. Temp. coefficient	PPM/°C	100PPM/°C from rated output voltage, following 30 minutes warm up													X	X

1.3 PROTECTIVE FUNCTIONS

1. OCP		0~105% Constant Current														X	X
2. OCP Foldback		Output shut down when power supply change from CV to CC. User selectable.														X	X
3. OVP type		Inverter shut-down, manual reset by AC input recycle or by OUT button or by communication port.														X	X
4. OVP trip point		0.5-7.5V 0.5-10V 1-15V 1-24V 2-36V 2-44V 5-57V 5-66V 5-88V 5-110V 5-165V 5-330V 5-660V														X	X
5. Over Temp. Protection		User selectable , latched or non latched														X	X

1.4 ANALOG PROGRAMMING AND MONITORING

1. Vout Voltage Programming		0~100%, 0-5V or 0-10V, user select. Accuracy and linearity: +/-0.5% of rated Vout.														X	X
2. Iout Voltage Programming		0~100%, 0-5V or 0-10V, user select. Accuracy and linearity: +/-1% of rated Iout.														X	X
3. Vout Resistor Programming		0~100%, 0-5/10Kohm full scale, user select. Accuracy and linearity: +/-1% of rated Vout.														X	X
4. Iout Resistor Programming		0~100%, 0-5/10Kohm full scale, user select. Accuracy and linearity: +/-1.5% of rated Iout.														X	X
5. On/Off control (rear panel)		By electrical. Voltage: 0-0.6V/2-15V or dry contact, user selectable logic														X	X
6. Output Current monitor		0-5V or 0-10V , accuracy: 1% , user selectable														X	X
7. Output Voltage monitor		0-5V or 0-10V , accuracy: 1% ,user selectable														X	X
8. Power Supply OK signal		TTL high (4-5V) -OK, 0V-Fail 500ohm series resistance														X	X
9. CV/CC indicator		Open collector, CC mode: On, CV mode: Off, Maximum voltage: 30V, maximum sink current: 10mA														X	X
10. Enable/Disable		Dry contact. Open/off , Short: on. Max. voltage at Enable/Disable in: 6V														X	X
11. Local/Remote analog control		By electrical signal or Open/Short: 0-0.6V or short: Remote, 2-15V or open: Local.														X	X
12. Local/Remote analog control indicator		Open collector, Local: Open, Remote: On. Maximum voltage: 30V, maximum sink current: 5mA.														X	X

1.5 FRONT PANEL

1. Control functions		Vout/ Iout manual adjust by separate encoders (coarse and fine adjustment selectable)														X	X
		OVP/UVL manual adjust by Volt. Adjust encoder														X	X
		AC on/off, Output on/off, Re-start modes (auto, safe), Foldback control (CV to CC), Go to local control														X	X
		Address selection by Voltage (or current) adjust encoder. Number of addresses: 31														X	X
		RS232/485 and IEEE488.2 selection by IEEE enable switch and DIP switch														X	X
		Baudrate selection: 1200, 2400, 4800, 9600 and 19,200														X	X
2. Display		Voltage 4 digits, accuracy: 0.5% +/- 1 count														X	X
		Current 4 digits, accuracy: 0.5% +/- 1 count														X	X
3. Indications		Voltage, Current, Alarm, Fine, Preview, Foldback, Local, Output On, Front Panel Lock														X	X

1.6 Interface RS-232&RS-485 or Optional GPIB / LAN Interface

Model	V	6	8	12.5	20	30	40	50	60	80	100	150	300	600	750W	1500W
1. Remote Voltage Programming (16 bit)																
Resolution (0.012% of Vo Rated)	mV	0.72	0.96	1.50	2.40	3.60	4.80	6	7.2	9.6	12	18	36	72	X	X
Accuracy (0.05%Vo Rated+0.05% of Vo Actual Output)	mV	6.0	8.0	12.5	20	30	40	50	60	80	100	150	300	600	X	X
2. Remote Current Programming (16 bit)																
Resolution (0.012% of Io Rated)	mA	12	10.8	7.2	4.56	3.0	2.28	---	1.50	1.14	0.90	0.60	0.30	0.16	X	
Accuracy (0.1% of Io Rated+0.1% of Io Actual Output)	mA	200	180	120	76	50	38	---	25	19	15	10	5.0	2.6	X	
Resolution (0.012% of Io Rated)	mA	24	21.6	14.4	9.12	6.0	4.56	3.60	3.0	2.28	1.80	1.20	0.60	0.32		X
Accuracy (0.1% of Io Rated+0.1% of Io Actual Output)	mA	400	360	240	152	100	76	60	50	38	30	20	10	5.2		X
3. Readback Voltage																
Resolution (0.012% of Vo Rated)	mV	0.72	0.96	1.50	2.40	3.60	4.80	6.0	7.2	9.6	12	18	36	72	X	X
Accuracy (0.1%Vo Rated+0.1% of Vo Actual Output)	mV	12	16	25	40	60	80	100	120	160	200	300	600	1200	X	X
4. Readback Current																
Resolution (0.012% of Io Rated)	mA	12	10.8	7.2	4.56	3.0	2.28	---	1.50	1.14	0.90	0.60	0.30	0.16	X	
Accuracy (0.3% of Io Rated+0.1% of Io Actual Output)	mA	400	360	240	152	100	76	---	50	38	30	20	10	5.2	X	
Resolution (0.012% of Io Rated)	mA	24	21.6	14.4	9.12	6	4.56	3.60	3.0	2.28	1.80	1.20	0.60	0.32		X
Accuracy (0.3% of Io Rated+0.1% of Io Actual Output)	mA	800	720	480	304	200	152	120	100	76	60	40	20	10.4		X
5. OVP/UVL Programming																
Resolution (0.1% of Vo Rated)	mV	6	8	12	20	30	40	50	60	80	100	150	300	600	X	X
Accuracy (1% of Vo Rated)	mV	60	80	125	200	300	400	500	600	800	1000	1500	3000	6000	X	X

- *1: Minimum voltage is guaranteed to maximum 0.2% of Vo Rated. *3: At maximum output power. *5: From No-load to Full-load, constant input voltage.
*2: Minimum current is guaranteed to maximum 0.4% of Io Rated. *4: 85-132Vac or 170-265Vac, constant load. *6: For load voltage change, equal to the unit voltage rating, constant input voltage.
*7: For 6V models the ripple is measured at 2-6V output voltage and full output current. For other models, the ripple is measured at 10-100% output voltage and full output current.
*8: Time for the output voltage to recover within 0.5% of its rated for a load change 10-90% of rated output , Output set-point: 10-100%.
*9 For 6V-300V models: measured with JEITA RC-9131A 1:1 probe. For 600V model: measured with 10:1 probe
Accuracy -Values have been calculated at Vo Rated & Io Rated

General Specifications Genesys™ 750W/1500W TDK-Lambda

2.1 INPUT CHARACTERISTICS

1. Input voltage/freq. (*1)	85~265Vac continuous, 47~63Hz, single phase
2. Power Factor	0.99 @100/200Vac, rated output power.
3. EN61000-3-2,3 compliance	Complies with EN61000-3-2 class A and EN61000-3-3 at 20~100% output power.
4. Input current 100/200Vac	750W :10.5A / 5A, 1500W :21A / 11A
5. Inrush current 100/200Vac	750W :Less than 25A, 1500W :Less than 50A
6. Hold-up time	More than 20mS , 100Vac , at 100% load.

2.2 POWER SUPPLY CONFIGURATION

1. Parallel Operation	Up to 4 units in master/slave mode with single wire current balance connection
2. Series Operation	Up to 2 units. with external diodes. 600V Max to Chassis ground

2.3 ENVIRONMENTAL CONDITIONS

1. Operating temp	0~50°C, 100% load.
2. Storage temp	-20~70°C
3. Operating humidity	30~90% RH (non-condensing).
4. Storage humidity	10~95% RH (non-condensing).
5. Vibration	MIL-810E, method 514.4 , test cond. I-3.3.1. The EUT is fixed to the vibrating surface.
6. Shock	Less than 20G , half sine , 11mSec. Unit is unpacked.
7. Altitude	Operating: 10000ft (3000m), Derat output current by 2%/100m above 2000m, Non operating: 40000ft (12000m).

2.4 EMC

1. Applicable Standards:	
2. ESD	IEC1000-4-2. Air-disch.-8KV, contact disch.-4KV
3. Fast transients	IEC1000-4-4. 2KV
4. Surge immunity	IEC1000-4-5. 1KV line to line, 2KV line to ground
5. Conducted immunity	IEC1000-4-6, 3V
6. Radiated immunity	IEC1000-4-3, 3V/m
7. Conducted emission	EN55022B, FCC part 15J-B, VCCI-B.
8. Radiated emission	EN55022A, FCC part 15-A, VCCI-A.
9. Voltage dips	EN61000-4-11
10. Conducted emission	EN55022B, FCC part 15-B, VCCI-B.
11. Radiated emission	EN55022A, FCC part 15-A, VCCI-A.

2.5 SAFETY

1. Applicable standards:	CE Mark, UL60950, EN60950 listed. Vout<60V: Output is SELV , IEEE/Isolated analog are SELV. 60<Vout<400V: Output is hazardous, IEEE/Isolated analog are SELV. 400<Vout<600V: Output is hazardous, IEEE/Isolated analog are not SELV.
2. Withstand voltage	Vout<60V models :Input-Outputs (SELV): 3.0KVrms 1min, Input-Ground: 2.0KVrms 1min. 60<Vout<600V models: Input-Haz. Output: 2.5KVrms 1min, Input-SELV: 3KVrms 1min. Hazardous Output-SELV: 1.9KVrms 1min, Hazardous Output-Ground: 1.9KVrms 1min. Input-Ground: 2KVrms 1min.
3. Insulation resistance	More than 100Mohm at 25°C , 70% RH, 500Vdc

2.6 MECHANICAL CONSTRUCTION

1. Cooling	Forced air flow: from front to rear. No ventilation holes at the top or bottom of the chassis; Variable fan speed.
2. Dimensions (WxHxD)	W: 422.8mm, H: 43.6mm, D: 432.8mm (excluding connectors, encoders, handles, etc.)
3. Weight	750W: 7Kg (15 Lbs) 1500W: 8.5Kg (18 Lbs)
4. AC Input connector	750W: IEC320 AC Inlet. 1500W: Screw terminal block, Phoenix P/N: FRONT-4-H-7.62 , with strain relief
5. Output connectors	6V to 60V models: Bus-bars (hole Ø 8.5mm). 80V to 600V models: wire clamp connector, Phoenix P/N: FRONT-4-H-7.62

2.7 RELIABILITY SPECS

1. Warranty	5 years.
-------------	----------

*1: For cases where conformance to various safety standards (UL, IEC etc.) is required, to be described as 100-240Vac (50/60Hz).
All specifications subject to change without notice.

Outline Drawing Genesys™ 750W/1500W Units

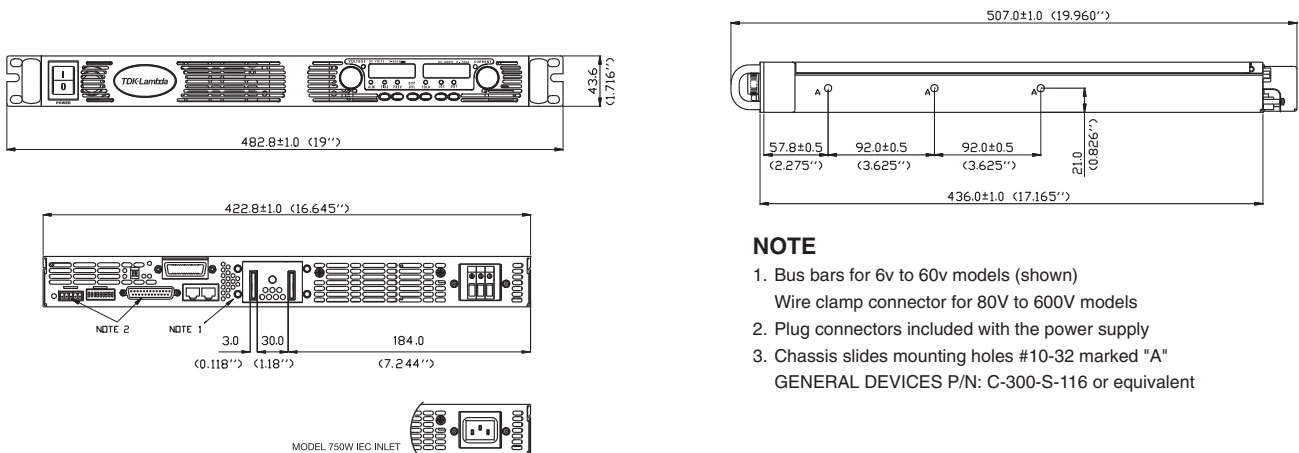

NOTE

1. Bus bars for 6v to 60v models (shown)
Wire clamp connector for 80V to 600V models
 2. Plug connectors included with the power supply
 3. Chassis slides mounting holes #10-32 marked "A"
- GENERAL DEVICES P/N: C-300-S-116 or equivalent

Genesys™ Power Parallel and Series Configurations

Parallel operation - Master/Slave:

Active current sharing allows up to four identical units to be connected in an auto-parallel configuration for four times the output power.

In Advanced Parallel Master/Slave Mode, total current is programmed and reported by the Master, Up to four supplies act as one.



Series operation

Up to two units may be connected in series to increase the output voltage or to provide bipolar output. (Max 600V to Chassis Ground).

Remote Programming via RS-232 & RS-485 Interface

Standard Serial Interface allows chain control of up to 31 power supplies on the same bus with built-in RS-232 & RS-485 Interface.

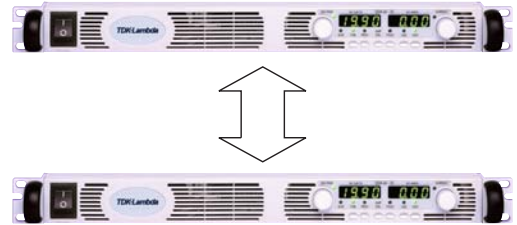
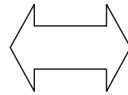

Programming Options (Factory installed)

Digital Programming via IEEE Interface

P/N: IEEE

- IEEE 488.2 SCPI Compliant
- Program Voltage
- Measure Voltage
- Over Voltage setting and shutdown
- Error and Status Messages
- **New! Multi-Drop**
 - Allows IEEE Master to control up to 31 slaves over RS-485 daisy-chain
 - Only the Master needs be equipped with IEEE Interface
- Program Current
- Measure Current
- Current Foldback shutdown

Isolated Analog Programming

Four Channels to Program and Monitor Voltage and Current. Isolation allows operation with floating references in harsh electrical environments. Choose between programming with Voltage or Current. Connection via removable terminal block: Phoenix MC1,5/8-ST-3.81.

- Voltage Programming, user-selectable 0-5V or 0-10V signal. P/N: IS510
 Power supply Voltage and Current Programming Accuracy $\pm 1\%$
 Power supply Voltage and Current Monitoring Accuracy $\pm 1.5\%$
- Current Programming with 4-20mA signal. P/N: IS420
 Power supply Voltage and Current Programming Accuracy $\pm 1\%$
 Power supply Voltage and Current Monitoring Accuracy $\pm 1.5\%$

LAN Interface

LXI Compliant to Class C

P/N: LAN

- Meets all LXI-C Requirements
- Address Viewable on Front Panel
- Fixed and Dynamic Addressing
- Compatible with most standard Networks
- VISA & SCPI Compatible
- LAN Fault Indicators
- Auto-detects LAN Cross-over Cable
- Fast Startup

How to order

GEN	600	-	2.6	-	-
Series Name	Output Voltage (0~600V)	Output Current (0~2.6A)	Factory Options Option: IEEE IS510 IS420 LAN	AC Cable option is 750W only	Region: E - Europe GB - United Kingdom J - Japan I - Middle East U - North America

Models 750/1500W





Model	Output Voltage VDC	Output Current (A)	Output Power (W)
GEN6-100	0-6V	0-100	600
GEN6-200		0-200	1200
GEN8-90	0-8V	0-90	720
GEN8-180		0-180	1440
GEN12.5-60	0-12.5V	0-60	750
GEN12.5-120		0-120	1500
GEN20-38	0-20V	0-38	760
GEN20-76		0-76	1520
GEN30-25	0-30V	0-25	750
GEN30-50		0-50	1500
GEN40-19	0-40V	0-19	760
GEN40-38		0-38	1520

Model	Output Voltage VDC	Output Current (A)	Output Power (W)
GEN50-30	0-50V	0-30	1500
GEN60-12.5	0-60V	0-12.5	750
GEN60-25		0-25	1500
GEN80-9.5	0-80V	0-9.5	760
GEN80-19		0-19	1520
GEN100-7.5	0-100V	0-7.5	750
GEN100-15		0-15	1500
GEN150-5	0-150V	0-5	750
GEN150-10		0-10	1500
GEN300-2.5	0-300V	0-2.5	750
GEN300-5		0-5	1500
GEN600-1.3	0-600V	0-1.3	780
GEN600-2.6		0-2.6	1560

Factory option

RS-232/RS-485 Interface built-in Standard	P/N
GPIOB Interface	-
Voltage Programming Isolated Analog Interface	IEEE
Current Programming Isolated Analog Interface	IS510
LAN Interface (Complies with LXI Class C)	IS420
	LAN

AC Cords sets (750W only)

Region	Europe	United Kingdom	Japan	Middle East	North America
Output Power	750W	750W	750W	750W	750W
AC Cords	10A/250Vac L=2m	10A/250Vac L=2m	13A/125Vac L=2m	10A/250Vac L=2m	13A/125Vac L=2m
Wall Plug	INT'L 7/VII	BS1363		SI-32	NEMA 5-15P
Power Supply Connector	IEC320-C13	IEC320-C13	IEC320-C13	IEC320-C13	IEC320-C13
					
Part Number	P/N: GEN/E	P/N: GEN/GB	P/N: GEN/J	P/N: GEN/I	P/N : GEN/U

Accessories

1. Communication cable

RS-232/RS-485 Cable is used to connect the power supply to the PC Controller.

Mode	RS-485	RS-232	RS-232
PC Connector	DB-9F	DB-9F	DB-25F
Communication Cable	Shield Ground L=2m	Shield Ground L=2m	Shield Ground L=2m
Power Supply Connector	EIA/TIA-568A (RJ-45)	EIA/TIA-568A (RJ-45)	EIA/TIA-568A (RJ-45)
P/N	GEN/485-9	GEN/232-9	GEN/232-25

2. Serial link cable*

Daisy-chain up to 31 Genesys™ power supplies.

Mode	Power Supply Connector	Communication Cable	P/N
RS-485	EIA/TIA-568A (RJ-45)	Shield Ground L=50cm	GEN/RJ45

* Included with power supply

NORTH AMERICA

TDK-Lambda Americas Inc
405 Essex Rd. Neptune, NJ 07753
Tel: +1-732-922-9300 Fax: +1-732-922-1441
E-mail: sales@us.tdk-lambda.com
www.us.tdk-lambda.com/hp

UK

TDK-Lambda UK Ltd.
Kingsley Avenue Ilfracombe, Devon
EX 34 8ES United Kingdom
Tel: +44-1271-856666 Fax: +44-1271-864894
E-mail: powersolutions@emea.tdk-lambda.com
www.uk.tdk-lambda.com

FRANCE

TDK-Lambda France SAS
ZAC des Delaches
BP 1077 - Gometz le Chatel
91940 LES ULIS
Tel: +33 1 60 12 71 65
Fax: +33 1 60 12 71 66
E-mail: france@fr.tdk-lambda.com
www.fr.tdk-lambda.com

GERMANY

TDK-Lambda Germany GmbH
Karl-Bold-Str.40,
D-77855 Achern, Germany
Tel: +49-7841-666-0 Fax: +49-7841-500-0
E-mail: info.germany@de.tdk-lambda.com
www.de.tdk-lambda.com

AUSTRIA

TDK-Lambda Austria Sales Office
Aredstrasse 22,
A - 2544 Leobersdorf, Austria
Tel: +43-2256-65584 Fax: +43-2256-64512
E-mail: info.germany@de.tdk-lambda.com
www.de.tdk-lambda.com

ITALY

TDK-Lambda Italy S.r.l
Via dei Lavoratori 128/130
IT20092 Cinisello Balsamo, Milano, Italy
Tel: +39-02-6129-3863 Fax: +39-02-6129-0900
E-mail: info.italia@lambda-europe.com
www.it.tdk-lambda.com

SCANDINAVIA

TDK-Lambda Scandinavia
Rallarvägen 41
SE-184 40 Akersberga
Sweden
Tel: +46 854 084 990
Fax: +46 854 066 096
E-mail: info@se.tdk-lambda.com
www.se.tdk-lambda.com

ISRAEL

Nemic Lambda Ltd.
Sales Office: Kibbutz Givat Hashlosha Tel-Aviv 48800, Israel
Tel: +972-3-9024-333 Fax: +972-3-9024-777
Plant: POB 500 Karmiel Industrial Zone 21651, Israel
Tel: +972-4-9887-491 Fax: +972-4-9583-347
www.nemic.co.il E-mail: info@nemic.co.il

JAPAN

TDK-Lambda Corporation,
5F Dempa Bldg, 1-11-15 Higashigotanda,
Shinagawa-Ku, Tokyo 141-0022, Japan
Tel: +81 3 3447 4693
Fax: +81 3 3447 4750
www.tdk-lambda.com

CHINA

Shanghai Branch of Wuxi TDK-Lambda Electronic Co. Ltd.
28F, Xingyuan Technology Building No.418, Guiping Road,
Shanghai, China 200233
Tel: +86-21-6485-0777 Fax: +86-21-6485-0666
www.tdk-lambda.com.cn

Beijing Branch of Wuxi TDK-Lambda Electronic Co. Ltd.
Room 12B11-12B12, Unit 7 DACHENG SQUARE, No.28
Xuanwumenxi Street, Xuanwu District Beijing, 100053, CHINA
Tel: +86-10-6310-4872 Fax: +86-10-6310-4874
www.tdk-lambda.com.cn

TDK-Lambda Corporation, Hong Kong Office
Room. 8, 27/F, Mega Trade Center
1 Mei Wan St. Tsuen Wan, N.T. Hong Kong
Tel: +852-2420-6693 Fax: +852-2420-3362
www.tdk-lambda.com.cn

KOREA

TDK-Lambda Corporation Seoul Office
6F Songok Bldg. 4-1 Soonae-Dong
Pundang-Gu, Songnam-Shi Kyonggi-Do, 463-020 Korea
Tel: +82-31-717-7051 +82-31-726-9137
www.tdk-lambda.com

SINGAPORE

TDK-Lambda Singapore Pte.Ltd.
Blk 1008 Toa Payoh North # 06-01/08
Singapore 318996
Tel: +65-6251-7211 Fax: +65-6250-9171
www.tdk-lambda.com.sg

INDIA

TDK-Lambda Bangalore Office
3302, 12th 'A' Main, Hal 2nd Stage
Bangalore, Karnataka, 560 008 India
Tel: +91-80-64503815 Fax: +91-80-25263148
www.tdk-lambda.com.sg

MALAYSIA

TDK-Lambda (M) Sdn. Bhd.
Suite 4.3, Level 4, Menara Merais, No.1, Jalan 19/3, Section 19/3,
46300 Petaling Jaya, Selangor Darul Ehsan Malaysia
Tel: +60-3-7957-8800 Fax: +60-3-7958-2400
www.tdk-lambda.com



TDK-Lambda EMEA
www.emea.tdk-lambda.com