



**Synchronous Buck  
 Multiphase Optimized BGA Power Block**  
 Integrated Power Semiconductors, Drivers & Passives

**Features:**

- 20A continuous output current with no derating up to  $T_{PCB} = 90^{\circ}\text{C}$
- Very small 11mm x 11mm x 3mm profile
- Internal features minimize layout sensitivity \*
- Optimized for very low power losses
- 3.3 to 12V input voltage



**iP2001 Power Block**

**Description**

The iP2001 is a fully optimized solution for high current synchronous buck multiphase applications. Board space and design time are greatly reduced because most of the components required for each phase of a typical discrete-based multiphase circuit are integrated into a single 11mm x 11mm x 3mm BGA power block. The only additional components required for a complete multiphase converter are a PWM IC, the external inductors, and the input and output capacitors.

iPOWIR technology offers designers an innovative board space saving solution for applications requiring high power densities. iPOWIR technology eases design for applications where component integration offers benefits in performance and functionality. iPOWIR technology solutions are also optimized internally for layout, heat transfer and component selection.

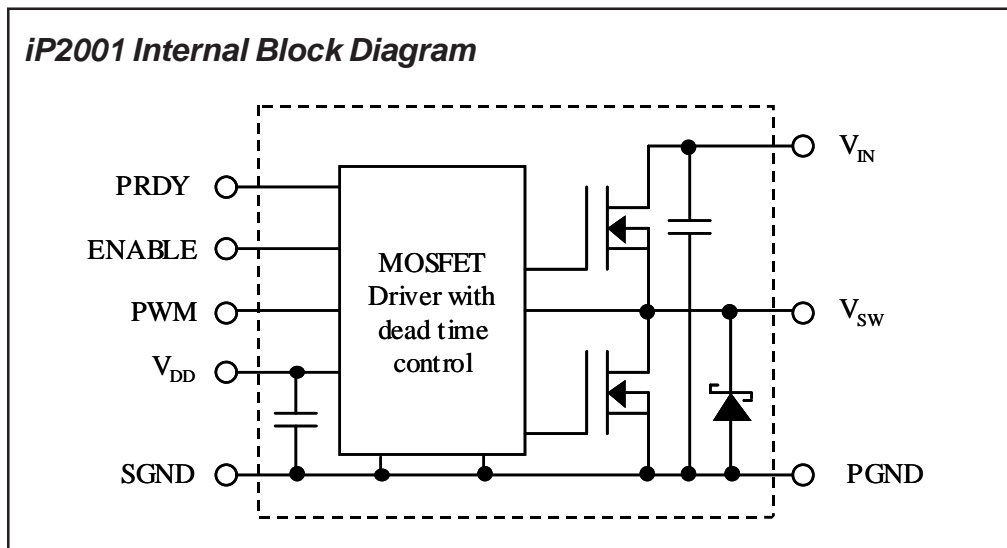

\* All of the difficult PCB layout and bypassing issues have been addressed with the internal design of the iPOWIR Block. There are no concerns about double pulsing, unwanted shutdown, or other malfunctions which often occur in switching power supplies. The iPOWIR Block will function normally without any additional input power supply bypass capacitors. However, for reliable long term operation it is recommended that the adequate amount of input decoupling is provided on the V<sub>IN</sub> pin. No additional bypassing is required on the V<sub>DD</sub> pin.

# iP2001

All specifications @ 25°C (unless otherwise specified)

## Absolute Maximum Ratings :

Parameter	Min	Typ	Max	Units	Conditions
$V_{IN}$ to PGND	-	-	16	V	
Output RMS Current	-	-	20	A	
$V_{DD}$ to SGND	-	-	6.0	V	
DRV_IN to SGND	-0.3	-	6.0	V	
Enable to SGND	-0.3	-	6.0	V	
Storage Temperature	-40	-	125	°C	

## Recommended Operating Conditions :

Parameter	Symbol	Min	Typ	Max	Units	Conditions
Supply Voltage	$V_{DD}$	4.6	5.0	5.5	V	
Input Voltage Range	$V_{IN}$	3.0	-	12.6	V	
Output Voltage Range	$V_{OUT}$	0.9	-	3.3	V	see Figs. 2 & 4
Output Current Range	$I_{OUT}$	-	-	20	A	see Fig. 2
Operating Frequency	fsw	150	-	1000	kHz	see Figs. 2 & 5

## Electrical Specifications @ $V_{DD} = 5V$ (unless otherwise specified) :

Parameter	Symbol	Min	Typ	Max	Units	Conditions
Block Power Loss ①	$P_{BLK}$	-	3.1	3.8	W	$V_{IN} = 12V, V_{OUT} = 1.6V,$ $I_{OUT} = 20A, f_{sw} = 500kHz$
Turn On Delay ②	$t_{d(on)}$	-	63	-	ns	
Turn Off Delay ②	$t_{d(off)}$	-	26	-		
$V_{IN}$ Quiescent Current	$I_{Q-VIN}$	-	-	1.0	mA	Enable = 0V, $V_{IN} = 12V$
$V_{DD}$ Quiescent Current	$I_{Q-VDD}$	-	-	10	μA	Enable = 0V, $V_{DD} = 5V$
Under Voltage Lockout	UVLO					
Start Threshold	$V_{START}$	4.2	4.4	4.5	V	
Hysteresis	$V_{Hys-UVLO}$	-	.05	-		
Enable	Enable					
Input Voltage High	$V_{IH}$	2.0	-	-	V	
Input Voltage Low	$V_{IL}$	-	-	0.8		
Power Ready	PRDY					
Logic Level High	$V_{OH}$	4.5	4.6	-	V	$V_{DD} = 4.6V, I_{Load} = 10mA$
Logic Level Low	$V_{OL}$	-	0.1	0.2		$V_{DD} < UVLO \text{ Threshold}, I_{Load} = 10\mu A$
Drive Input	DRV_IN					
Logic Level High	$V_{OH}$	2.0	-	-	V	
Logic Level Low	$V_{OL}$	-	-	0.8		

① Measurement were made using four 10uF (TDK C3225X7R1C106M or equiv.) capacitors across the input (see Fig. 8).

② Not associated with the rise and fall times. Does not affect Power Loss (see Fig. 9).

**Pin Description Table**

Pin Name	Ball Designator	Pin Function
V <sub>DD</sub>	A1 – A3, B1 – B3	Supply voltage for the internal circuitry.
V <sub>IN</sub>	A5 – A12, B5 – B12, C5 - C10	Input voltage for the DC-DC converter.
PGND	C11, C12, D11, D12, E11, E12, F6, F7, F12, G6, G7, G12, H6, H7, H12, J6, J7, J12, K5 – K7, K12, L5, L6, L12, M5 – M7, M12	Power Ground - connection to the ground of bulk and filter capacitors.
V <sub>SW</sub>	D5 – D10, E5 – E10, F8 – F11, G8 – G11, H8 – H11, J8 – J11, K8 – K11, L8 – L11, M8 – M11	Switching Node - connection to the output inductor.
SGND	C1 – C3, D1 –D3, E1 –E3	Signal Ground.
ENABLE	F1	When set to logic level high, internal circuitry of the device is enabled. When set to logic level low, the PRDY pin is forced low, the Control and Synchronous switches are turned off, and the supply current is less than 10 $\mu$ A.
PRDY	K1	Power Ready - This pin indicates the status of V <sub>DD</sub> . When V <sub>DD</sub> is less than 4.4V(typ.), this output is driven low. When V <sub>DD</sub> is greater than 4.4V(typ.), this output is driven high. This output has a 10mA source and 10 $\mu$ A sink capability.
PWM	H1	TTL-level input signal to MOSFET drivers.
NC	B4, C4, D4, E4, F2 – F4, G2 – G4, H2 – H4, J1, J2 – J4, K3, L1, L2, M1 – M4	This pin is not for electrical connection. It should be attached only to dead copper.

# iP2001

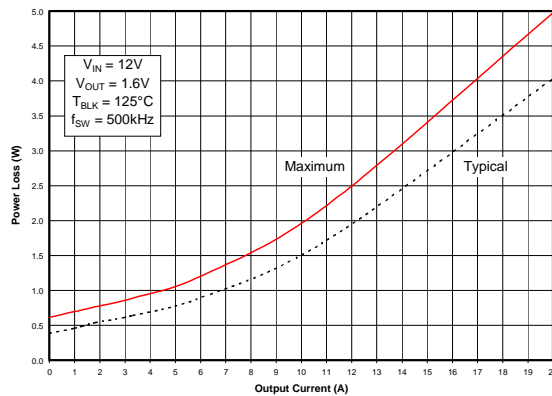

Fig 1. Power Loss vs. Current

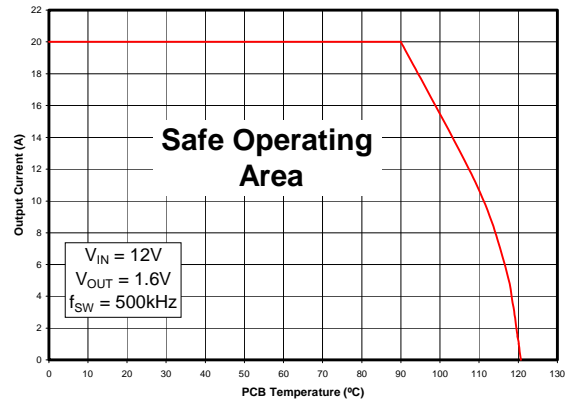

Fig 2. Safe Operating Area (SOA) vs.  $T_{PCB}$  \*  
(\*see AN-1030 for details)

## Adjusting the Power Loss and SOA curves for different operating conditions

To make adjustments to the power loss curves in Fig. 1, multiply the normalized value obtained from the curves in Figs. 3, 4, 5 or 6 by the value indicated on the power loss curve in Fig. 1. If multiple adjustments are required, multiply all of the normalized values together, then multiply that product by the value indicated on the power loss curve in Fig. 1. The resulting product is the final power loss based on all factors.

To make adjustments to the SOA curve in Fig. 2, determine the maximum allowed PCB temperature in Fig. 2 at the required operating current. Then, add the correction temperature from the normalized curves in Figs. 3, 4, 5 or 6 to find the final maximum allowable PCB temperature. When multiple adjustments are required, add all of the temperatures together, then add the sum to the PCB temperature indicated on the SOA graph to determine the final maximum allowable PCB temperature based on all factors.

### Operating Conditions for the examples below:

Output Current = 20A                      Input Voltage = 7V  
Output Voltage = 2.5V                      Sw Freq= 750kHz

### Adjusting for Maximum Power Loss:

- (Fig. 1) Maximum power loss = 5W
- (Fig. 3) Normalized power loss for input voltage  $\approx 0.925$
- (Fig. 4) Normalized power loss for output voltage  $\approx 1.1$
- (Fig. 5) Normalized power loss for frequency  $\approx 1.225$

$$\text{Adjusted Power Loss} = 5W \times 1.1 \times 0.925 \times 1.225 \approx \underline{6.23W}$$

### Adjusting for SOA Temperature:

- (Fig. 2) SOA PCB Temperature = 90°C
- (Fig. 3) Normalized SOA PCB Temperature for input voltage  $\approx 2.6^\circ\text{C}$
- (Fig. 4) Normalized SOA PCB Temperature for output voltage  $\approx -3.5^\circ\text{C}$
- (Fig. 5) Normalized SOA PCB Temperature for frequency  $\approx -7.5^\circ\text{C}$

$$\text{Adjusted SOA PCB Temperature} = 90^\circ\text{C} - 3.5^\circ\text{C} + 2.6^\circ\text{C} - 7.5^\circ\text{C} \approx \underline{81.6^\circ\text{C}}$$

Typical Performance Curves

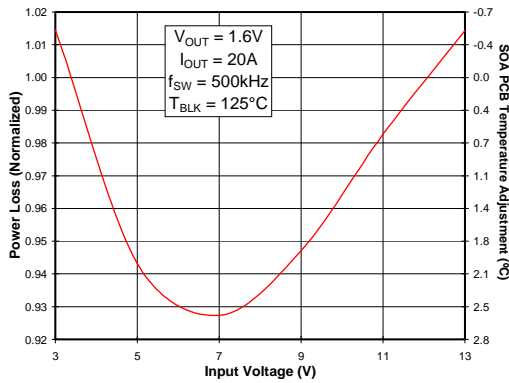

Fig 3. Normalized Power Loss vs.  $V_{IN}$

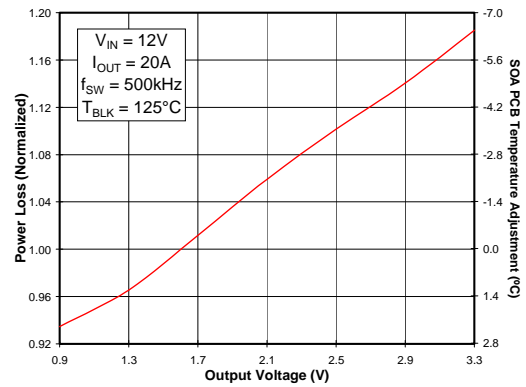

Fig 4. Normalized Power Loss vs.  $V_{OUT}$

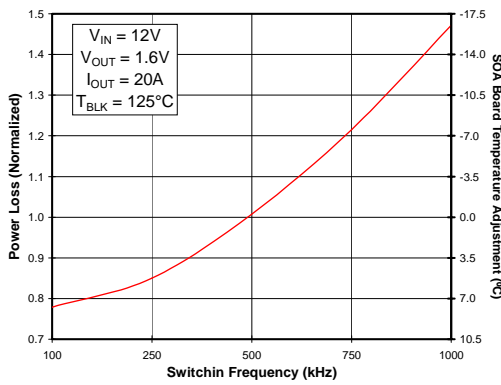

Fig 5. Normalized Power Loss vs. Frequency

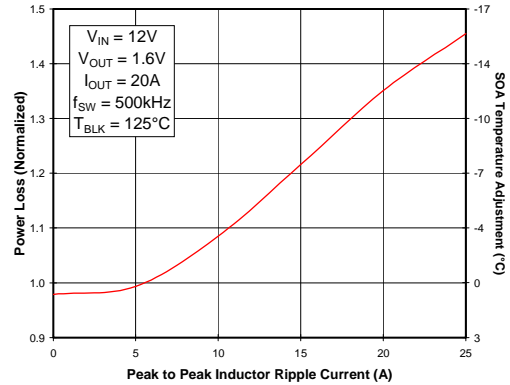

Fig 6. Normalized Power Loss vs. Ripple Current

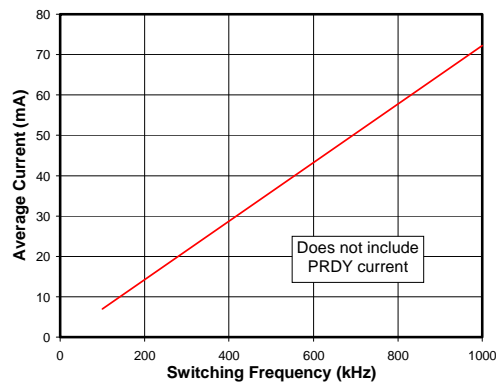
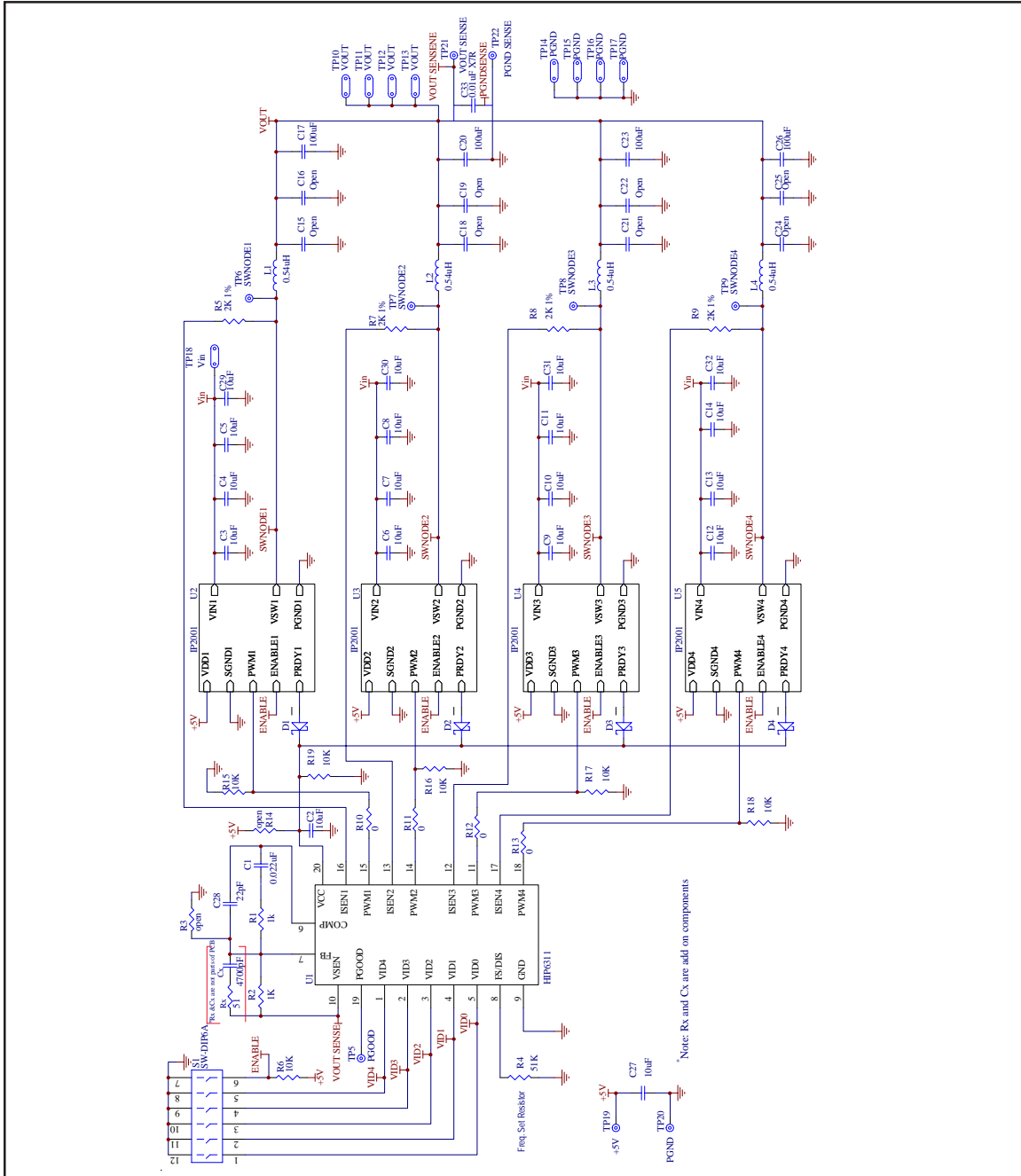

Fig 7.  $I_{DD}$  vs. Frequency



### 4-Phase Reference Design Schematic

Designator	Value 1	Value 2	Type	Tolerance	Package	Mfr. 1	Mfr. 1 Part No.	Mfr. 2	Mfr. 2 Part No.
C1	.022uF	50V	X7R	10%	0805	ROHM	MCR215C223KK	-	-
C2-C14, C27, C29-C32	10uF	16V	X5R	10%	1210	TDK	C3225X5R1C106KT	Murata	GRM42-2 X5R 106K16
C15, C16, C18, C19, C21, C22, C24, C25	-	-	-	-	-	-	-	-	-
C17, C20, C23, C26	100uF	6.3V	X5R	10%	2220	TDK	C5750X5R0J107KT	MuRata	GRM44-1-X5R 107K 6.3
C28	22pF	50V	NPO	5%	0805	TDK	C2012X7R1H220JT	ROHM	MCH215A220JK
C33	0.01uF	50V	X7R	10%	0805	TDK	C2012X7R1H103KT	SAMSUNG	CL21B103KBNC
Cx	4700pF	50V	X7R	10%	0603	Phicomp	06032R472K9B20	-	-
D1 - D4	30V	100mA	Schottky	-	SOT23	Central	CMPSH-3	-	-
L1 - L4	0.54uH	27A	Ferrite	20%	SMT	Panasonic	ETQP6F0R6BFA	Bi Technologies	HM73-30R60
R1 & R2	1KΩ	1/8W	Thick film	5%	0805	ROHM	MCR10EZJH102	-	-
R3 & R14	-	-	-	-	-	-	-	-	-
R4	51KΩ	1/8W	Thick film	5%	0805	ROHM	MCR10EZJHW513	-	-
R5, R7, R8, R9	2KΩ	1/8W	Thick film	1%	0805	KOA	RK73H2A2001F	-	-
R6, R15 - R19	10KΩ	1/8W	Thick film	5%	0805	ROHM	MCR10EZJH103	-	-
R10 - R13	0Ω	1/8W	Thick film	<50mΩ	0805	ROHM	MCR10EZJH000	-	-
Rx	51Ω	1/10W	Thick film	5%	0603	KOA	RM73B1J510J	-	-
S1	SPST	6 position	DIP	-	SMT	C&K Comp.	SD06H0SK	-	-
ST1 - ST4	Stand Off	-	-	-	4-40	Keystone	8412K	-	-
U1	4.6-6 V	0-1.850V	PWM IC	0 - 70°C	20 Ld SOIC	Intersil	HIP6311CB	-	-
U2 - U5	-	-	-	-	11x11mm	IR	iP2001	-	-

### 4-Phase Reference Design Bill of Materials

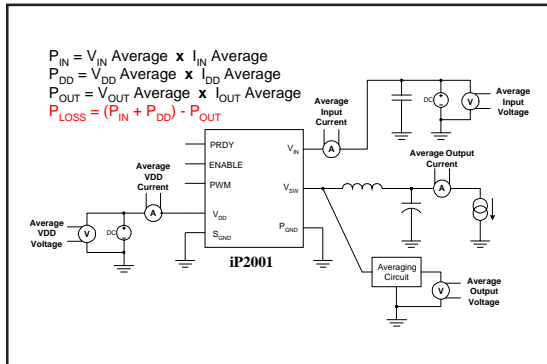

Fig 8. Power Loss Test Circuit

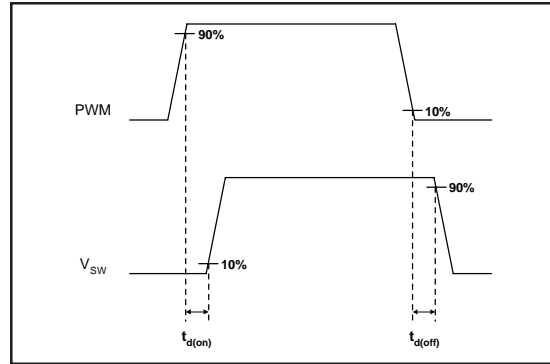
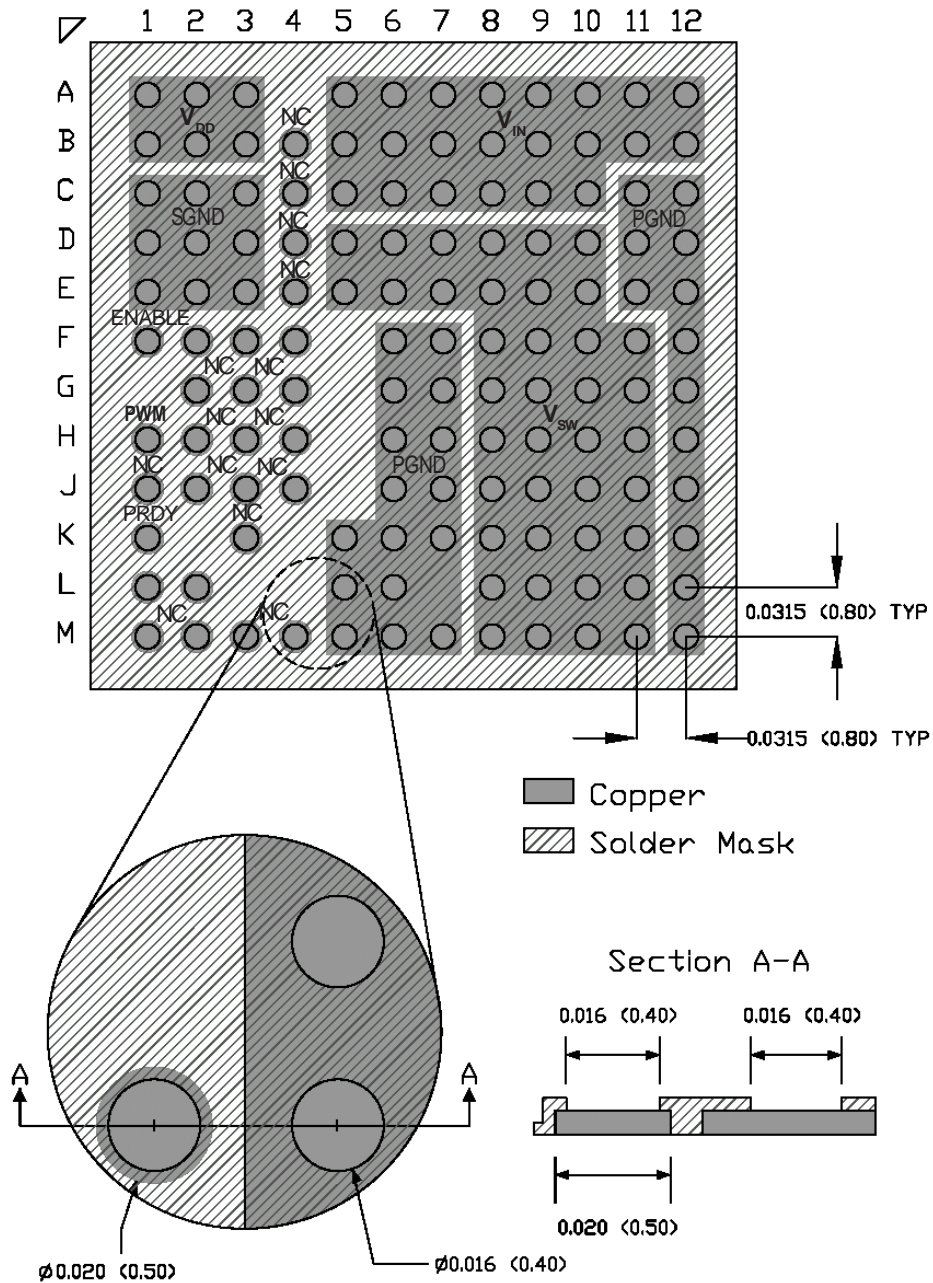
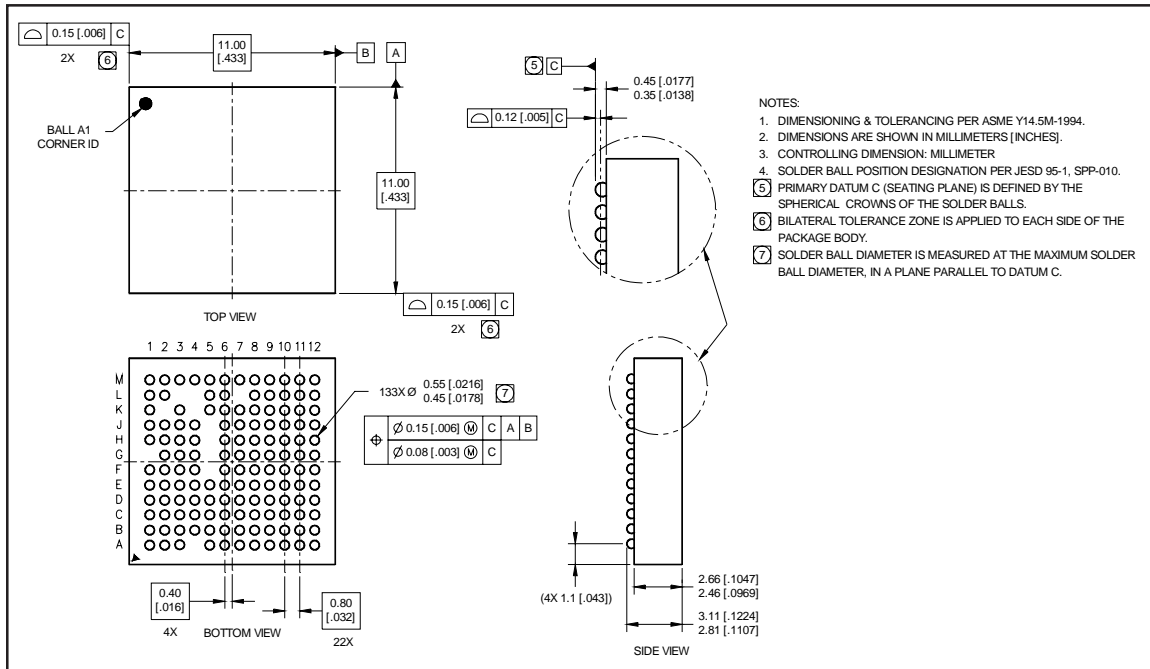

Fig 9. Timing Diagram



**Recommended PCB Footprint (Top View)**





### Mechanical Drawing

Refer to the following application notes for detailed guidelines and suggestions when implementing iPOWIR Technology products:

#### **AN-1028: Recommended Design, Integration and Rework Guidelines for International Rectifier's iPOWIR Technology BGA Packages**

This paper discusses the assembly considerations that need to be taken when mounting iPOWIR BGA's on printed circuit boards. This includes soldering, pick and place, reflow, inspection, cleaning and reworking recommendations.

#### **AN-1029: Optimizing a PCB Layout for an iPOWIR Technology Design**

This paper describes how to optimize the PCB layout design for both thermal and electrical performance. This includes placement, routing, and via interconnect suggestions.

#### **AN-1030: Applying iPOWIR Products in Your Thermal Environment**

This paper explains how to use the Power Loss and SOA curves in the data sheet to validate if the operating conditions and thermal environment are within the Safe Operating Area of the iPOWIR product.

# iP2001

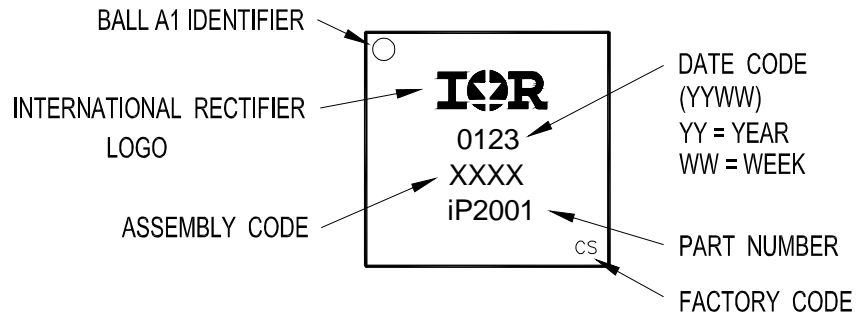

## Part Marking

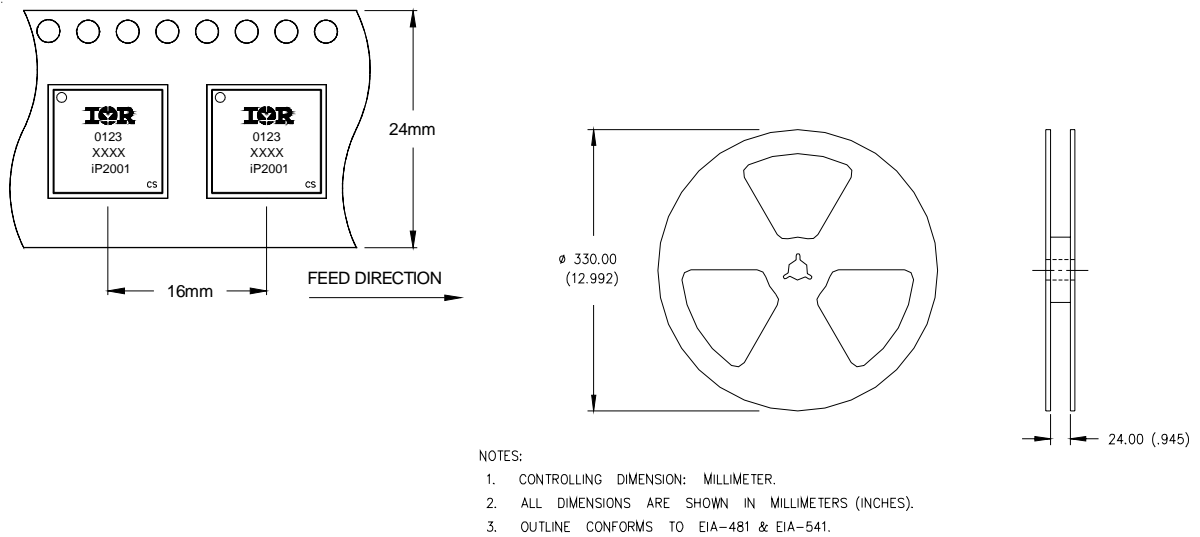

## Tape & Reel Information

*Data and specifications subject to change without notice.  
This product has been designed and qualified for the industrial market.  
Qualification Standards can be found on IR's Web site.*

**IR WORLD HEADQUARTERS:** 233 Kansas St., El Segundo, California 90245, USA Tel: (310) 252-7105  
TAC Fax: (310) 252-7903  
Visit us at [www.irf.com](http://www.irf.com) for sales contact information.8/01