

REFERENCE DESIGN

IRDCiP2001-B

International Rectifier • 233 Kansas Street, El Segundo, CA 90245 USA

IRDCiP2001-B, 500kHz, 60A, 3-phase Synchronous Buck Converter using iP2001

Overview

In this document, table 1 and figure 1 are provided to enable engineers to easily evaluate the iP2001 in a 3-phase configuration that is capable of providing up to 60A in a lab environment without airflow. Figures 3, 4, 5 and 6 and the complete bill of materials in table 2 are provided as a reference design to enable engineers to very quickly and easily design a 3-phase converter. In order to optimize this design to your specific requirements refer to the data sheet for the controller listed in the bill of materials. A variety of other controllers may also be used, but the design will require layout and control circuit modifications.

iPOWIR™
TECHNOLOGY

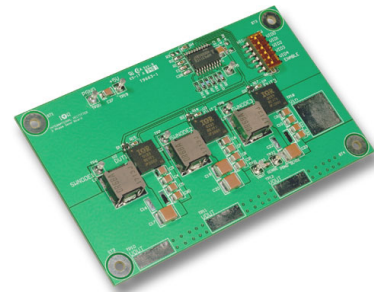

Demoboard Quick Start Guide

Initial Settings:

- The output is set to 1.7V, but can be adjusted from 1.1 to 1.85V by setting S1 according to the VID codes provided in Table 1. Droop control is set to 50mV at 60A, but can be adjusted by following the instructions in the data sheet for the PWM controller.
- The switching frequency per phase is set to 500kHz with the frequency set resistor R4. This creates an effective output frequency of 1.5MHz. The graph in figure 1 shows the relationship between R4 and the switching frequency per phase. This frequency may be adjusted by changing R4 according to this graph; however, extreme changes from the 500kHz set point may require redesigning the control loop and adjusting the values of input and output capacitors. Also, refer to the SOA graph in the iP2001 datasheet for maximum operating current at different frequencies.

Procedure for Connecting and Powering Up Demoboard:

1. Apply input voltage (5-12V) across V_{IN} (TP18) and PGND (TP14). Note that this input source must be applied first during the power-up sequence.
2. Apply +5V logic power across +5V (TP19) and PGND (TP20).
3. Apply load across VOUT pads (TP10 - TP12) and PGND pads (TP14 - TP16)
4. Set ENABLE high.
5. Monitor switch node signals (optional) via TP6 - TP8.
6. Adjust load accordingly.

iP2001 Recommended Operating Conditions

(refer to the iP2001 datasheet for maximum operating conditions)

Input voltage: 5 - 12V
Output voltage: 1.1 - 1.85V
Output current: 20A per phase, 60A total for 3-phase demo board.
Switching Freq: 500kHz per phase, 1.5MHz effective output frequency.

07/19/02

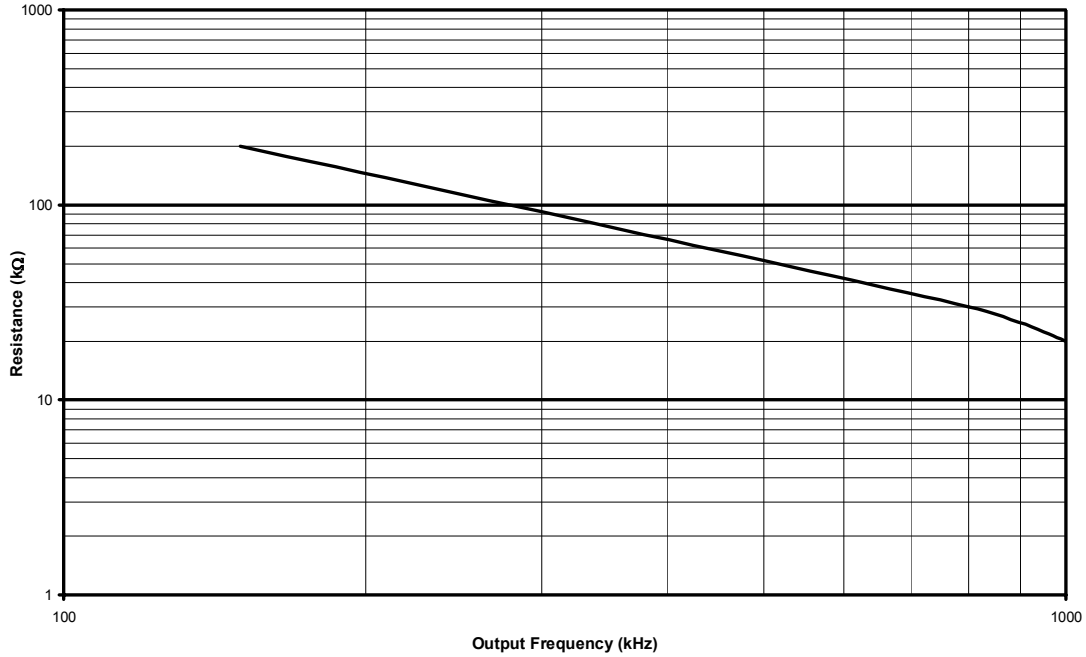

Figure 1 - R4 vs. Frequency per Phase

VID4	VID3	VID2	VID1	VID0	VDAC	VID4	VID3	VID2	VID1	VID0	VDAC
1	1	1	1	1	Off	0	1	1	1	1	1.475
1	1	1	1	0	1.100	0	1	1	1	0	1.500
1	1	1	0	1	1.250	0	1	1	0	1	1.525
1	1	1	0	0	1.150	0	1	1	0	0	1.550
1	1	0	1	1	1.175	0	1	0	1	1	1.575
1	1	0	1	0	1.200	0	1	0	1	0	1.600
1	1	0	0	1	1.225	0	1	0	0	1	1.625
1	1	0	0	0	1.250	0	1	0	0	0	1.650
1	0	1	1	1	1.275	0	0	1	1	1	1.675
1	0	1	1	0	1.300	0	0	1	1	0	1.700
1	0	1	0	1	1.325	0	0	1	0	1	1.725
1	0	1	0	0	1.350	0	0	1	0	0	1.750
1	0	0	1	1	1.375	0	0	0	1	1	1.775
1	0	0	1	0	1.400	0	0	0	1	0	1.800
1	0	0	0	1	1.425	0	0	0	0	1	1.825
1	0	0	0	0	1.450	0	0	0	0	0	1.850

Table 1 - PWM IC Voltage Identification Codes

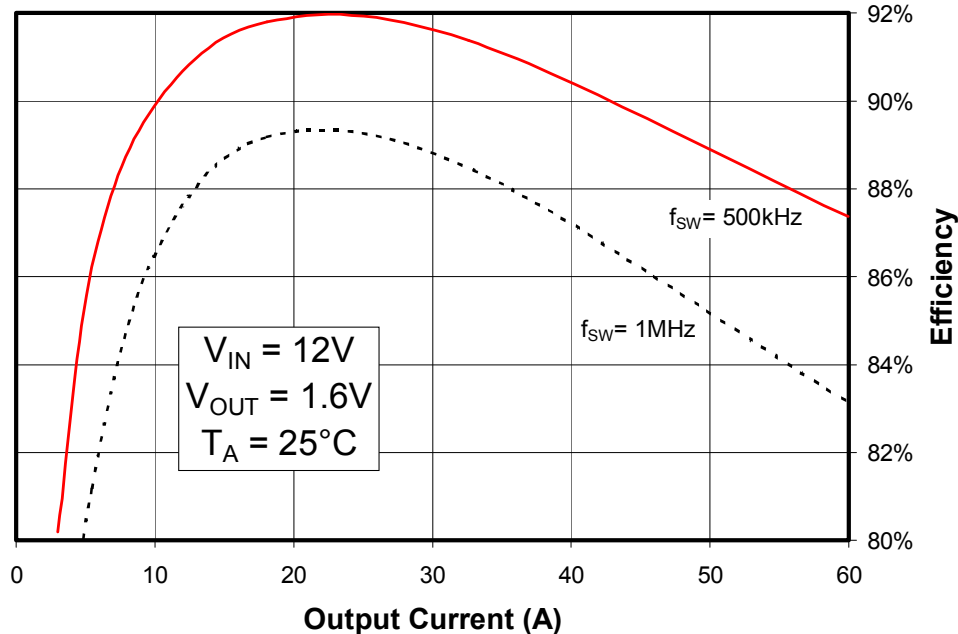

Figure 2 - Typical Efficiency vs. Current

Refer to the following application notes for detailed guidelines and suggestions when implementing iPOWIR Technology products:

AN-1028: Recommended Design, Integration and Rework Guidelines for International Rectifier's iPOWIR Technology BGA Packages

This paper discusses the assembly considerations that need to be taken when mounting iPOWIR BGA's on printed circuit boards. This includes soldering, pick and place, reflow, inspection, cleaning and reworking recommendations.

AN-1029: Optimizing a PCB Layout for an iPOWIR Technology Design

This paper describes how to optimize the PCB layout design for both thermal and electrical performance. This includes placement, routing, and via interconnect suggestions.

AN-1030: Applying iPOWIR Products in Your Thermal Environment

This paper explains how to use the Power Loss and SOA curves in the data sheet to validate if the operating conditions and thermal environment are within the Safe Operating Area of the iPOWIR product.

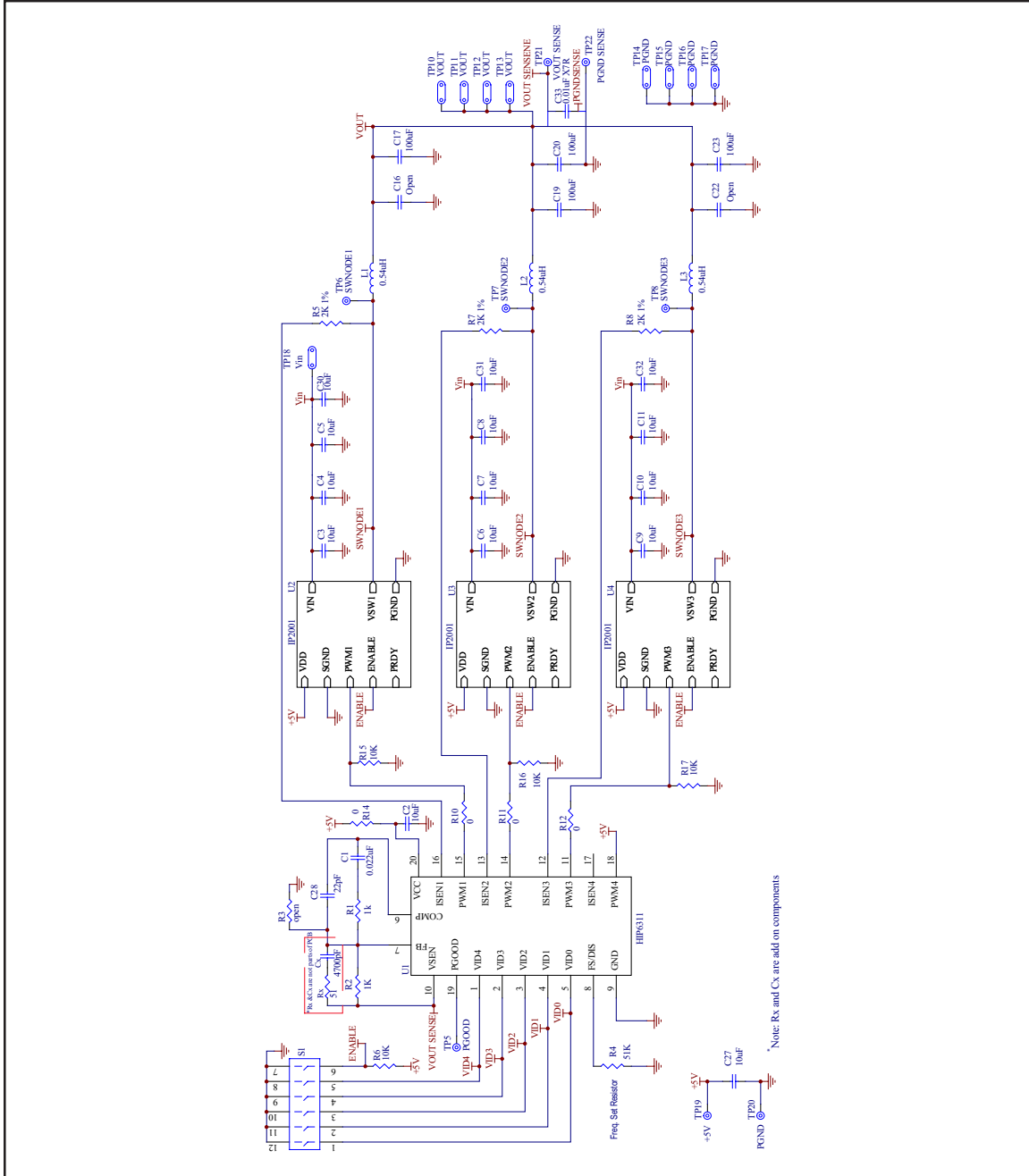

Fig. 3 - Reference Design Schematic

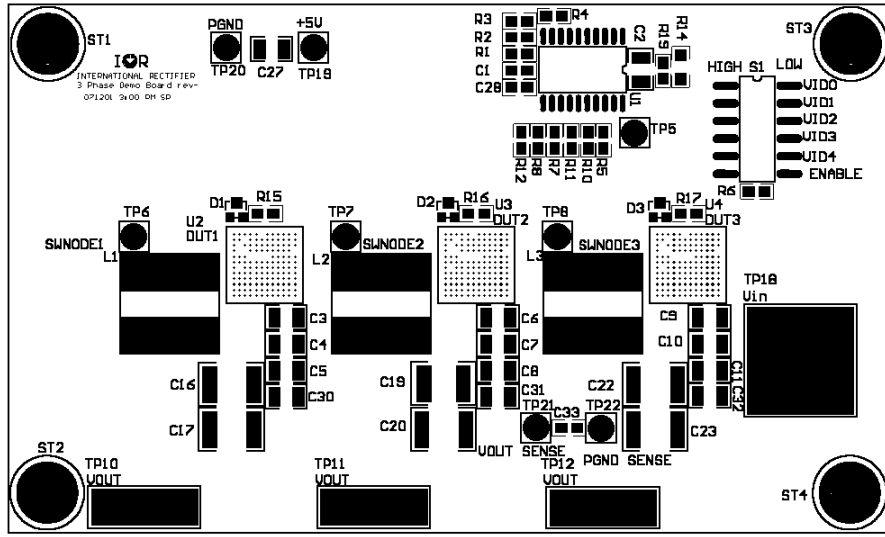

Fig. 4 - Component Placement Top Layer

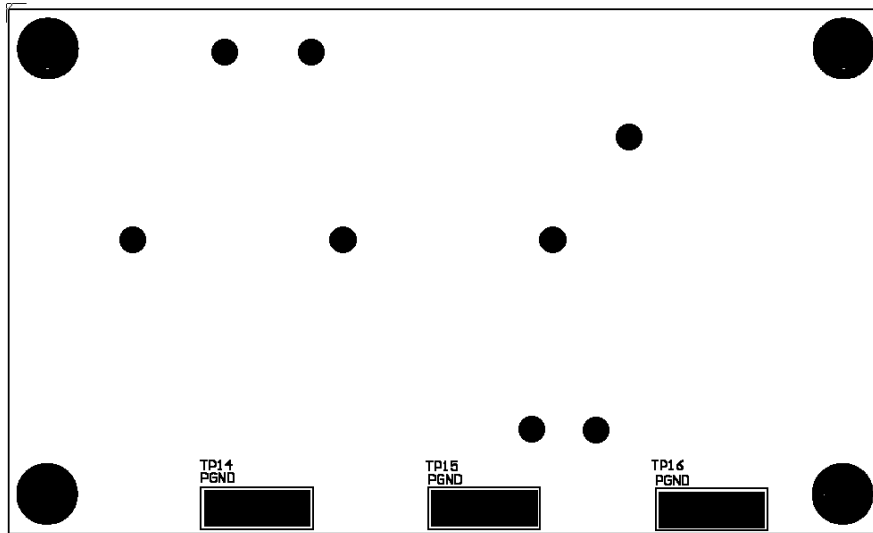

Fig. 5 - Component Placement Bottom Layer

Designator	Value 1	Value 2	Type	Tolerance	Package	Mfr.	Mfr. Part No.
C1	0.022uF	50V	X7R	10%	0805	TDK	C2012X7R1H223K
C2 - C11, C27, C30 - C32	10.0uF	16V	X5R	10%	1210	TDK	C3225X5R1C106K
C16, C22, D1 - D3, R3, R19	-	-	-	-	-	-	-
C17, C19, C20, C23	100uF	6.3V	X5R	10%	2220	TDK	C5750X5R0J107K
C28	22.0pF	50V	COG	5%	0805	TDK	C2012COG1H220J
C33	0.010uF	50V	X7R	10%	0805	TDK	C2012X7R1H103K
Cx	4700pF	50V	X7R	10%	0603	TDK	C1608X7R1H472K
L1 - L3	0.54uH	27A	Ferrite	20%	SMT	Panasonic	ETQP6F0R6BFA
R1, R2	1K	1/8W	Thick film	5%	0805	ROHM	MCR10EZJ102
R10 - R12, R14	0	1/8W	Thick film	<50m	0805	ROHM	MCR10EZJ000
R6, R15 - R17	10K	1/8W	Thick film	5%	0805	ROHM	MCR10EZJ103
R4	51K	1/8W	Thick film	5%	0805	ROHM	MCR10EZJ513
R5, R7, R8	2K	1/8W	Thick film	5%	0805	ROHM	MCR10EZJ202
Rx	51	1/10W	Thick film	5%	0603	KOA	RM73B1J510J
S1	SPST	6 position	Switch	-	SMT	C&K Components	SD06H0SK
ST1 - ST4	4-40	-	-	-	-	Keystone	8412
U1	-	-	PWM controller	0 - 70°C	SOIC20	Intersil	HIP6311CB
U2 - U4	-	-	DC-DC	-	11 x 11 x 3mm	IR	IP2001

Table 2 - Reference Design Bill of Materials

Adjusting the Over-Current Limit

R7 & R8 are the resistors used to adjust the over-current trip point. The trip point is a function of the controller and corresponds to 165% of the output current indicated on the x-axis of Fig. 6. For example, selecting a resistance of 1.5K at each phase will set the trip point to 165% of 15A, or 24.75A. The trip point for each phase on the demoboard is currently set to 165% of 20A, or 33A.

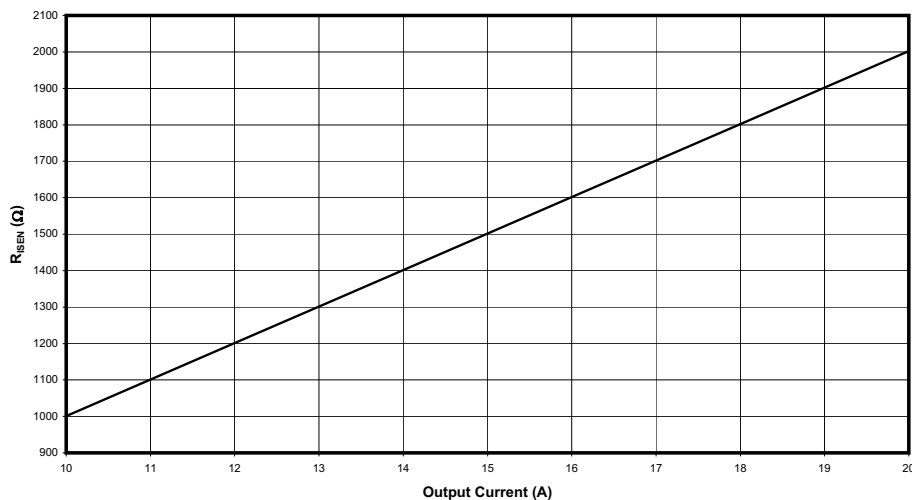

Fig. 6 - R_{ISEN} vs Current (per Phase)

Sequencing Tip

It's important to have proper sequencing between the control IC and the iP2001 blocks. This assures the soft-start routine of the IC will properly ramp-up the output voltage during a power-up or restart from shut down event. Figure 7 shows a simple and cost effective way to synchronize the iP2001 blocks with an HIP6311 control IC in a 3 Phase configuration.

Placing Schottky diodes between the iP2001's PRDY pin and the IC's FS/DIS pin creates an interface analogous to an AND operation. With this configuration, no single iP2001 can enable the IC independently. This configuration also resolves any differences in timing and logic thresholds between iP2001 devices. The capacitors are used to filter high frequency noise on the PRDY line. Additionally, the ENABLE pin of the iP2001 blocks can be used as the master control switch for the system.

During power-up, the PRDY pin is held low until V_{DD} reaches a typical voltage of 4.4V. Until then, the schottky diode is forward biased and clamps the FS/DIS pin well below the disable voltage of the HIP6311 IC (typically 1V). Upon reaching 4.4V, the PRDY pin transitions to a logic-level high state and releases the clamp on the FS/DIS pin. This enables the IC and allows its soft start routine to begin (see figure 8), assuming the voltage at the IC's V_{CC} pin is greater than its power-on reset threshold.

When the ENABLE pin is held to a logic-level low state (shut down mode), the PRDY pin clamps the FS/DIS pin of the IC below the disable voltage. After the ENABLE pin transitions to a logic-level high state, the PRDY releases the clamp on the FS/DIS pin, enabling the IC and allowing its soft start routine to begin (see figure 9).

During power-down, the PRDY pin transitions to a logic-level low state when the V_{DD} reaches the under voltage lock out threshold of the iP2001 blocks. The FS/DIS pin is then clamped below the disable voltage, disabling the control IC.

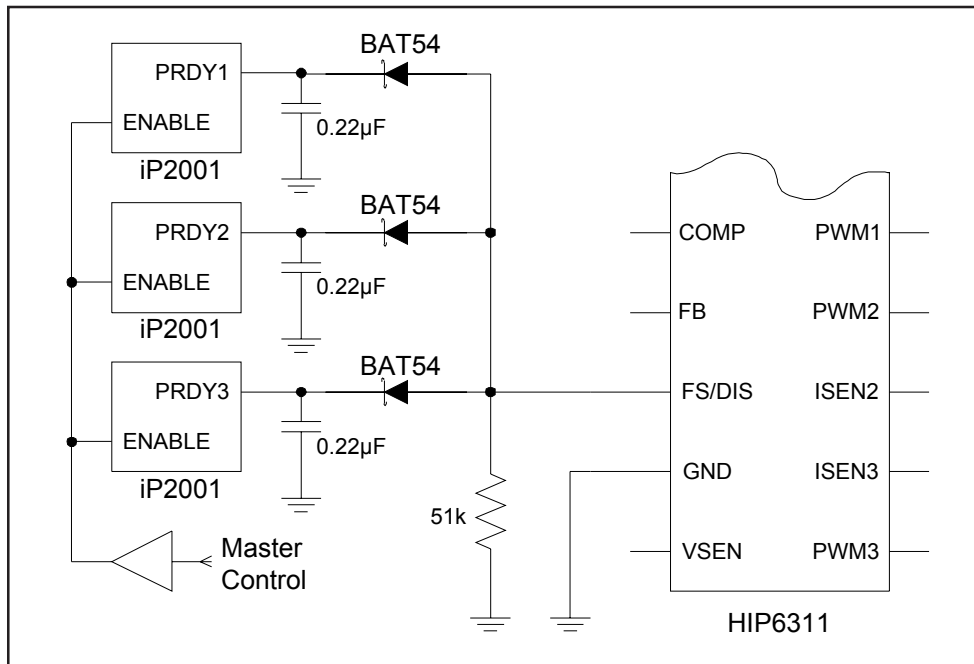

Fig. 7 - Sequencing Schematic

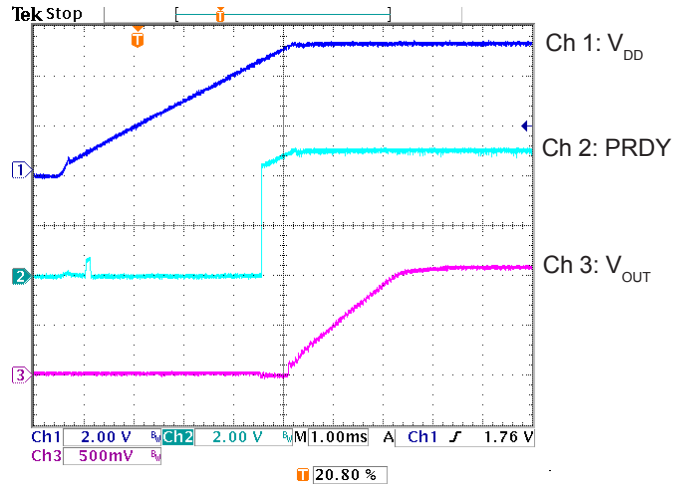

Fig. 8 - V_{DD} Rise vs. Output Timing

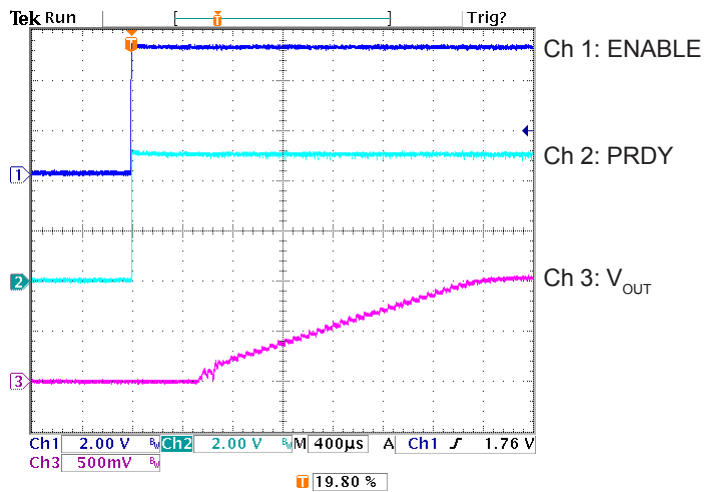

Fig. 9 - Enable On vs. Output Timing

Use of this design for any application should be fully verified by the customer. International Rectifier cannot guarantee suitability for your applications, and is not liable for any result of usage for such applications including, without limitation, personal or property damage or violation of third party intellectual property rights.

IR WORLD HEADQUARTERS: 233 Kansas St., El Segundo, California 90245, USA Tel: (310) 252-7105
 TAC Fax: (310) 252-7903

www.irf.com