

International IR Rectifier

REPETITIVE AVALANCHE AND dv/dt RATED

HEXFET[®] TRANSISTORS

THRU-HOLE (TO-204AA/AE)

[REF: MIL-PRF-19500/542]

200V, N-CHANNEL

IRF230

JANTX2N6758

JANTXV2N6758

Product Summary

Part Number	BVDSS	RDS(on)	ID
IRF230	200V	0.40Ω	9.0A



TO-3

The HEXFET[®] technology is the key to International Rectifier's advanced line of power MOSFET transistors. The efficient geometry and unique processing of this latest "State of the Art" design achieves: very low on-state resistance combined with high transconductance; superior reverse energy and diode recovery dv/dt capability.

The HEXFET transistors also feature all of the well established advantages of MOSFETs such as voltage control, very fast switching, ease of paralleling and temperature stability of the electrical parameters.

They are well suited for applications such as switching power supplies, motor controls, inverters, choppers, audio amplifiers and high energy pulse circuits.

Features:

- Repetitive Avalanche Ratings
- Dynamic dv/dt Rating
- Hermetically Sealed
- Simple Drive Requirements
- Ease of Paralleling

Absolute Maximum Ratings

	Parameter		Units
ID @ VGS = 10V, TC = 25°C	Continuous Drain Current	9.0	A
ID @ VGS = 10V, TC = 100°C	Continuous Drain Current	6.0	
IDM	Pulsed Drain Current ①	36	
PD @ TC = 25°C	Max. Power Dissipation	75	W
	Linear Derating Factor	0.6	W/°C
VGS	Gate-to-Source Voltage	±20	V
EAS	Single Pulse Avalanche Energy ②	54	mJ
IAR	Avalanche Current ①	9.0	A
EAR	Repetitive Avalanche Energy ①	7.5	mJ
dv/dt	Peak Diode Recovery dv/dt ③	5.0	V/ns
TJ	Operating Junction	-55 to 150	°C
TSTG	Storage Temperature Range		
	Lead Temperature	300 (0.063 in. (1.6mm) from case for 10s)	
	Weight	11.5(typical)	g

For footnotes refer to the last page

Electrical Characteristics @ Tj = 25°C (Unless Otherwise Specified)

	Parameter	Min	Typ	Max	Units	Test Conditions
BVDSS	Drain-to-Source Breakdown Voltage	200	—	—	V	VGS = 0V, ID = 1.0mA
ΔBVDSS/ΔTj	Temperature Coefficient of Breakdown Voltage	—	0.29	—	V/°C	Reference to 25°C, ID = 1.0mA
RDS(on)	Static Drain-to-Source On-State Resistance	—	—	0.40	Ω	VGS = 10V, ID = 6.0A④
		—	—	0.49		VGS = 10V, ID = 9.0A ④
VGS(th)	Gate Threshold Voltage	2.0	—	4.0	V	VDS = VGS, ID = 250μA
gfs	Forward Transconductance	3.0	—	—	S (Ω)	VDS > 15V, IDS = 6.0A④
IDSS	Zero Gate Voltage Drain Current	—	—	25	μA	VDS = 160V, VGS = 0V
		—	—	250		VDS = 160V VGS = 0V, Tj = 125°C
IGSS	Gate-to-Source Leakage Forward	—	—	100	nA	VGS = 20V
IGSS	Gate-to-Source Leakage Reverse	—	—	-100		VGS = -20V
Qg	Total Gate Charge	16	—	39	nC	VGS = 10V, ID = 9.0A VDS = 100V
Qgs	Gate-to-Source Charge	3.0	—	5.7		
Qgd	Gate-to-Drain ('Miller') Charge	8.0	—	20		
td(on)	Turn-On Delay Time	—	—	35	ns	VDD = 100V, ID = 9.0A, RG = 7.5Ω
tr	Rise Time	—	—	80		
td(off)	Turn-Off Delay Time	—	—	60		
tf	Fall Time	—	—	40		
LS + LD	Total Inductance	—	6.1	—	nH	Measured from the center of drain pad to center of source pad
Ciss	Input Capacitance	—	600	—	pF	VGS = 0V, VDS = 25V f = 1.0MHz
Coss	Output Capacitance	—	250	—		
Crss	Reverse Transfer Capacitance	—	80	—		

Source-Drain Diode Ratings and Characteristics

	Parameter	Min	Typ	Max	Units	Test Conditions
IS	Continuous Source Current (Body Diode)	—	—	9.0	A	
ISM	Pulse Source Current (Body Diode) ①	—	—	36		
VSD	Diode Forward Voltage	—	—	1.4	V	Tj = 25°C, IS = 9.0A, VGS = 0V ④
trr	Reverse Recovery Time	—	—	500	nS	Tj = 25°C, IF = 9.0A, di/dt ≤ 100A/μs
QRR	Reverse Recovery Charge	—	—	6.0	μc	VDD ≤ 50V ④
ton	Forward Turn-On Time	Intrinsic turn-on time is negligible. Turn-on speed is substantially controlled by LS + LD.				

Thermal Resistance

	Parameter	Min	Typ	Max	Units	Test Conditions
RthJC	Junction to Case	—	—	1.67	°C/W	Typical socket mount
RthJA	Junction to Ambient	—	—	30		

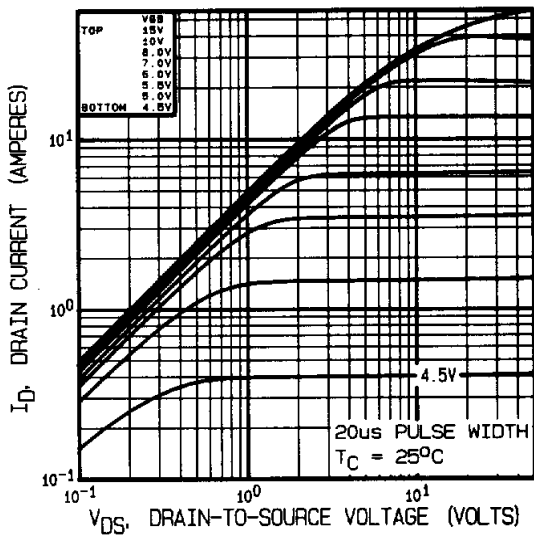

Fig 1. Typical Output Characteristics

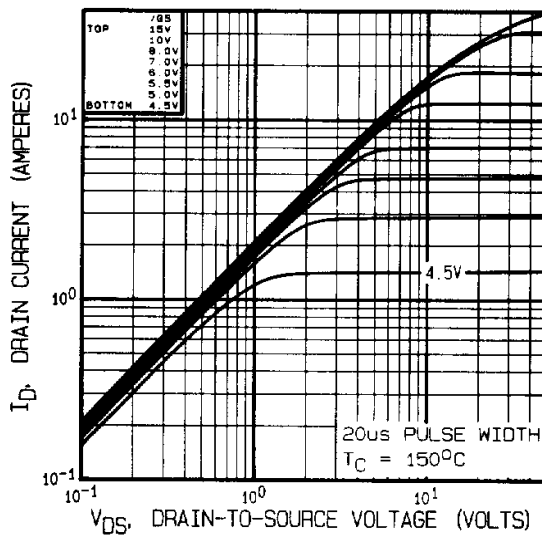

Fig 2. Typical Output Characteristics

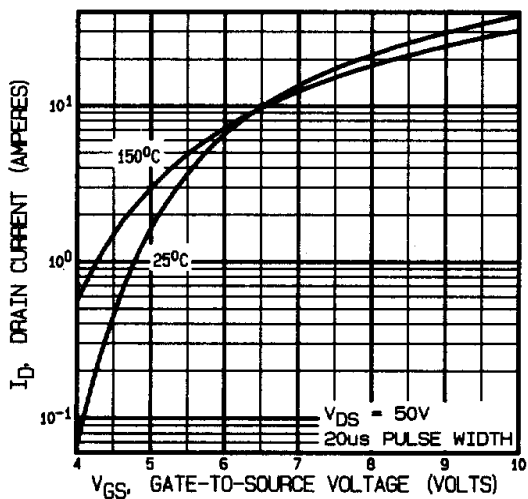

Fig 3. Typical Transfer Characteristics

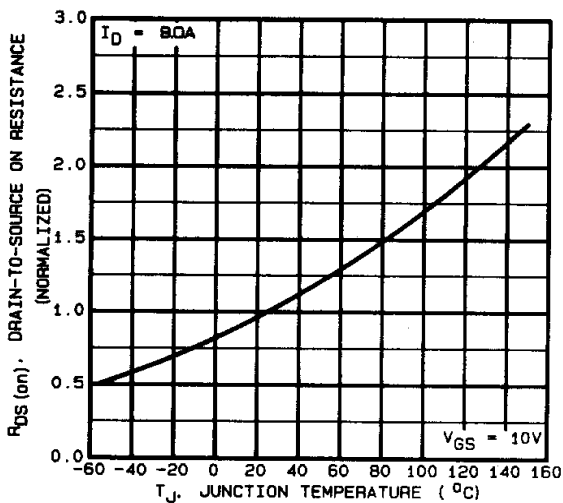

Fig 4. Normalized On-Resistance Vs. Temperature

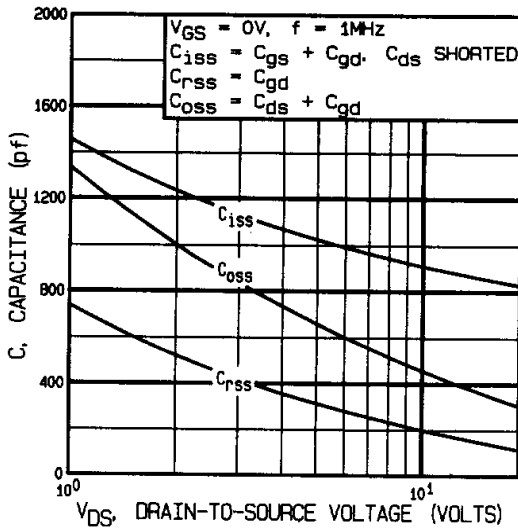

Fig 5. Typical Capacitance Vs. Drain-to-Source Voltage

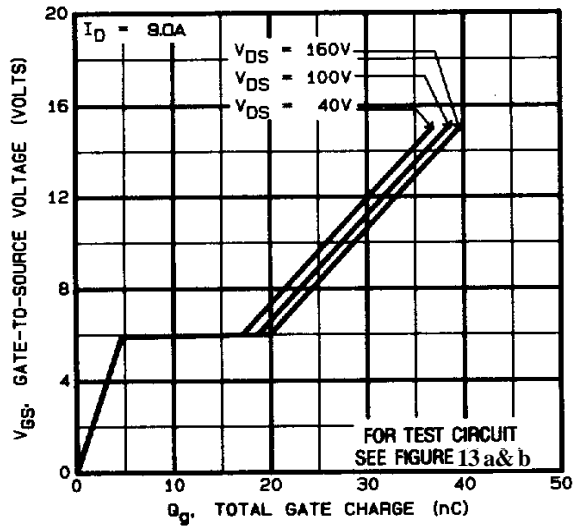

Fig 6. Typical Gate Charge Vs. Gate-to-Source Voltage

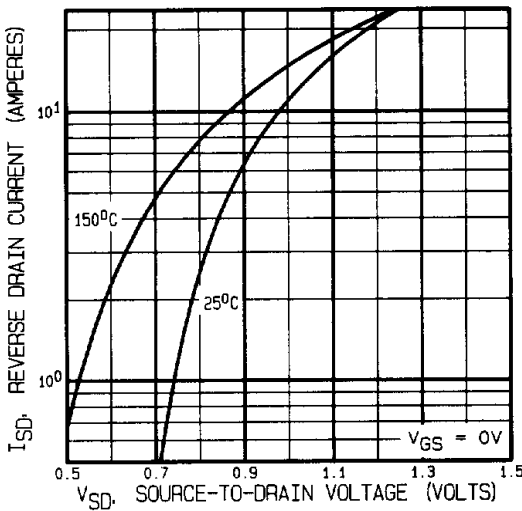

Fig 7. Typical Source-Drain Diode Forward Voltage

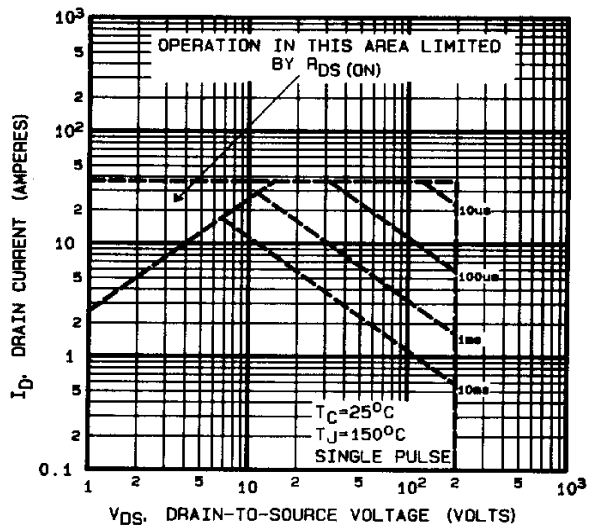

Fig 8. Maximum Safe Operating Area

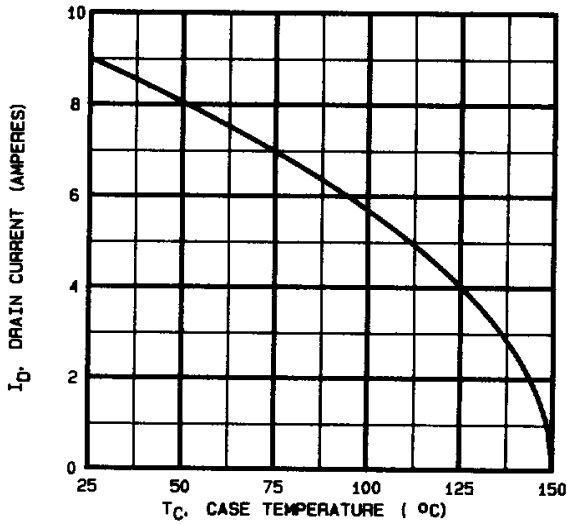

Fig 9. Maximum Drain Current Vs. Case Temperature



Fig 10a. Switching Time Test Circuit



Fig 10b. Switching Time Waveforms

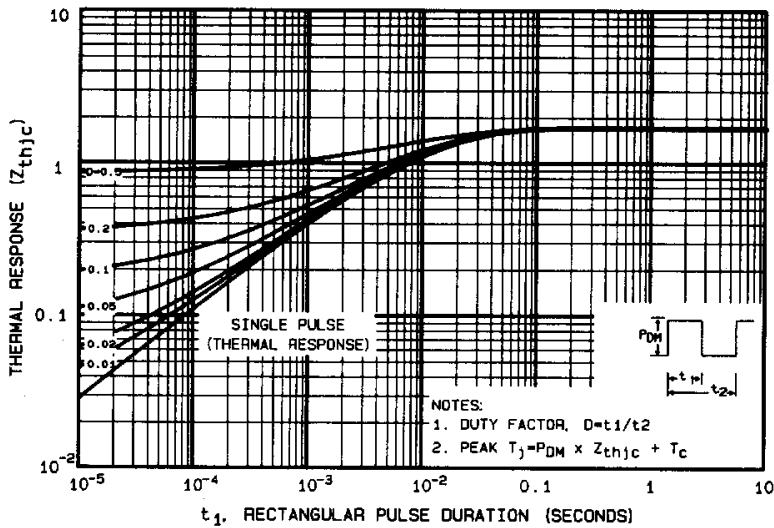

Fig 11. Maximum Effective Transient Thermal Impedance, Junction-to-Case

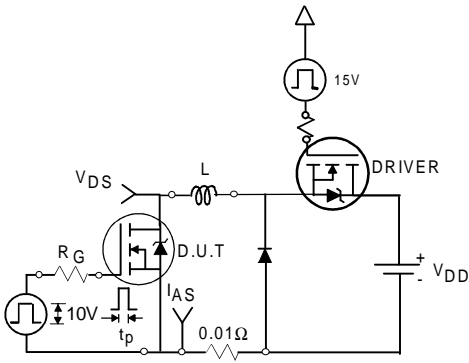

Fig 12a. Unclamped Inductive Test Circuit

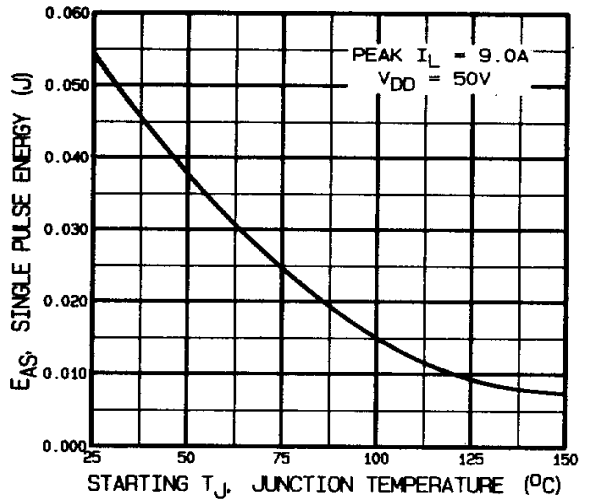

Fig 12c. Maximum Avalanche Energy Vs. Drain Current

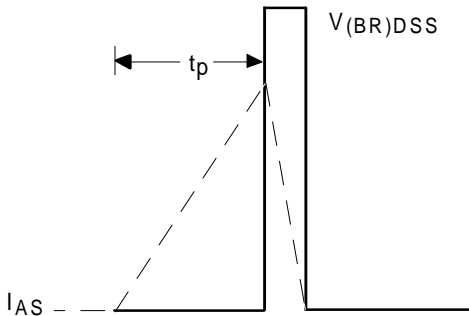

Fig 12b. Unclamped Inductive Waveforms



Fig 13a. Basic Gate Charge Waveform

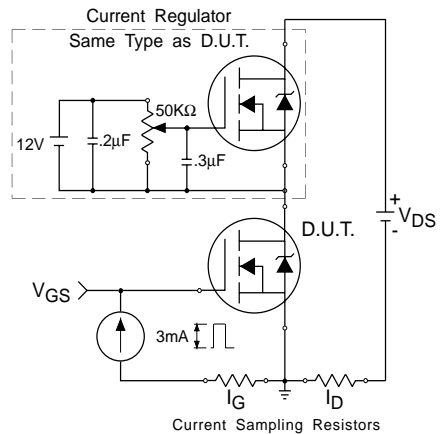
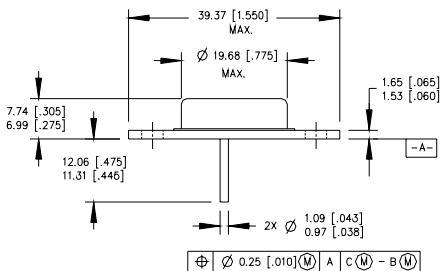

Fig 13b. Gate Charge Test Circuit

Foot Notes:

- ① Repetitive Rating; Pulse width limited by maximum junction temperature.
- ② $V_{DD} = 50V$, starting $T_J = 25^\circ C$,
Peak $I_L = 9.0A$,
- ③ $I_{SD} \leq 9.0A$, $di/dt \leq 120A/\mu s$,
 $V_{DD} \leq 200V$, $T_J \leq 150^\circ C$
Suggested $R_G = 7.5 \Omega$
- ④ Pulse width $\leq 300 \mu s$; Duty Cycle $\leq 2\%$

Case Outline and Dimensions — TO-204AA (Modified TO-3)



PIN ASSIGNMENTS

HEXFET	SCHOTTKY	IGBT
1 - SOURCE	1 - ANODE 1	1 - GATE
2 - GATE	2 - ANODE 2	2 - EMITTER
3 - DRAIN (CASE)	3 - COMMON CATHODE (CASE)	3 - COLLECTOR (CASE)

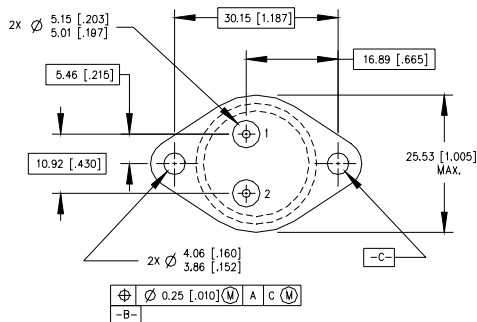

NOTES:

1. DIMENSIONING & TOLERANCING PER ANSI Y14.5M-1982.
2. CONTROLLING DIMENSION : INCH.
3. DIMENSIONS ARE SHOWN IN MILLIMETERS [INCHES].
4. OUTLINE CONFORMS TO JEDEC OUTLINE TO-204-AA.

This datasheet has been download from:

www.datasheetcatalog.com

Datasheets for electronics components.