

Power MOSFET

PRODUCT SUMMARY	
V_{DS} (V)	- 100
$R_{DS(on)}$ (Ω)	$V_{GS} = - 10$ V 0.60
Q_g (Max.) (nC)	18
Q_{gs} (nC)	3.0
Q_{gd} (nC)	9.0
Configuration	Single

FEATURES

- Dynamic dV/dt Rating
- Repetitive Avalanche Rated
- Surface Mount (IRFR9120/SiHFR9120)
- Straight Lead (IRFU9120/SiHFU9120)
- Available in Tape and Reel
- P-Channel
- Fast Switching
- Lead (Pb)-free Available



DPAK (TO-252)



IPAK (TO-251)

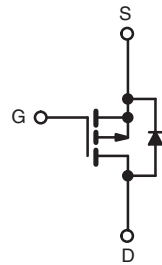
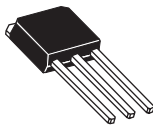

P-Channel MOSFET

DESCRIPTION

Third generation Power MOSFETs from Vishay provide the designer with the best combination of fast switching, ruggedized device design, low on-resistance and cost-effectiveness.

The DPAK is designed for surface mounting using vapor phase, infrared, or wave soldering techniques. The straight lead version (IRFU/SiHFU series) is for through-hole mounting applications. Power dissipation levels up to 1.5 W are possible in typical surface mount applications.

ORDERING INFORMATION				
Package	DPAK (TO-252)	DPAK (TO-252)	DPAK (TO-252)	IPAK (TO-251)
Lead (Pb)-free	IRFR9120PbF	IRFR9120TRPbF ^a	IRFR9120TRLPbF ^a	IRFU9120PbF
	SiHFR9120-E3	SiHFR9120T-E3 ^a	SiHFR9120TL-E3 ^a	SiHFU9120-E3
SnPb	IRFR9120	IRFR9120TR ^a	IRFR9120TRL ^a	IRFU9120PbF
	SiHFR9120	SiHFR9120T ^a	SiHFR9120TL ^a	SiHFU9120

Note

a. See device orientation.

ABSOLUTE MAXIMUM RATINGS $T_C = 25$ °C, unless otherwise noted				
PARAMETER	SYMBOL		LIMIT	UNIT
Drain-Source Voltage	V_{DS}		- 100	V
Gate-Source Voltage	V_{GS}		± 20	
Continuous Drain Current	V_{GS} at - 10 V	$T_C = 25$ °C	- 5.6	A
		$T_C = 100$ °C	- 3.6	
Pulsed Drain Current ^a	I_{DM}		- 22	W/°C
Linear Derating Factor			0.33	
Linear Derating Factor (PCB Mount) ^e			0.020	
Single Pulse Avalanche Energy ^b	E_{AS}		210	mJ
Repetitive Avalanche Current ^a	I_{AR}		- 5.6	A
Repetitive Avalanche Energy ^a	E_{AR}		4.2	mJ
Maximum Power Dissipation	$T_C = 25$ °C		42	W
Maximum Power Dissipation (PCB Mount) ^e	$T_A = 25$ °C		2.5	
Peak Diode Recovery dV/dt ^c	dV/dt		- 5.5	V/ns

* Pb containing terminations are not RoHS compliant, exemptions may apply

ABSOLUTE MAXIMUM RATINGS $T_C = 25\text{ }^\circ\text{C}$, unless otherwise noted			
PARAMETER	SYMBOL	LIMIT	UNIT
Operating Junction and Storage Temperature Range	T_J, T_{stg}	- 55 to + 150	°C
Soldering Recommendations (Peak Temperature)	for 10 s	260 ^d	

Notes

- a. Repetitive rating; pulse width limited by maximum junction temperature (see fig. 11).
- b. $V_{DD} = - 25\text{ V}$, starting $T_J = 25\text{ }^\circ\text{C}$, $L = 10\text{ mH}$, $R_G = 25\text{ }\Omega$, $I_{AS} = - 5.6\text{ A}$ (see fig. 12).
- c. $I_{SD} \leq - 6.8\text{ A}$, $dI/dt \leq 110\text{ A}/\mu\text{s}$, $V_{DD} \leq V_{DS}$, $T_J \leq 150\text{ }^\circ\text{C}$.
- d. 1.6 mm from case.
- e. When mounted on 1" square PCB (FR-4 or G-10 material).

THERMAL RESISTANCE RATINGS					
PARAMETER	SYMBOL	MIN.	TYP.	MAX.	UNIT
Maximum Junction-to-Ambient	R_{thJA}	-	-	110	°C/W
Maximum Junction-to-Ambient (PCB Mount) ^a	R_{thJA}	-	-	50	
Maximum Junction-to-Case (Drain)	R_{thJC}	-	-	3.0	

Note

- a. When mounted on 1" square PCB (FR-4 or G-10 material).

SPECIFICATIONS $T_J = 25\text{ }^\circ\text{C}$, unless otherwise noted							
PARAMETER	SYMBOL	TEST CONDITIONS		MIN.	TYP.	MAX.	UNIT
Static							
Drain-Source Breakdown Voltage	V_{DS}	$V_{GS} = 0\text{ V}$, $I_D = - 250\text{ }\mu\text{A}$		- 100	-	-	V
V_{DS} Temperature Coefficient	$\Delta V_{DS}/T_J$	Reference to $25\text{ }^\circ\text{C}$, $I_D = - 1\text{ mA}$		-	- 0.098	-	V/°C
Gate-Source Threshold Voltage	$V_{GS(th)}$	$V_{DS} = V_{GS}$, $I_D = - 250\text{ }\mu\text{A}$		- 2.0	-	- 4.0	V
Gate-Source Leakage	I_{GSS}	$V_{GS} = \pm 20\text{ V}$		-	-	± 100	nA
Zero Gate Voltage Drain Current	I_{DSS}	$V_{DS} = - 100\text{ V}$, $V_{GS} = 0\text{ V}$		-	-	- 100	μA
		$V_{DS} = - 80\text{ V}$, $V_{GS} = 0\text{ V}$, $T_J = 125\text{ }^\circ\text{C}$		-	-	- 500	
Drain-Source On-State Resistance	$R_{DS(on)}$	$V_{GS} = - 10\text{ V}$	$I_D = - 3.4\text{ A}^b$	-	-	0.60	Ω
Forward Transconductance	g_{fs}	$V_{DS} = - 50\text{ V}$, $I_D = - 3.4\text{ A}$		1.5	-	-	S
Dynamic							
Input Capacitance	C_{iss}	$V_{GS} = 0\text{ V}$, $V_{DS} = - 25\text{ V}$, $f = 1.0\text{ MHz}$, see fig. 5		-	390	-	pF
Output Capacitance	C_{oss}			-	170	-	
Reverse Transfer Capacitance	C_{rss}			-	45	-	
Total Gate Charge	Q_g	$V_{GS} = - 10\text{ V}$	$I_D = - 6.8\text{ A}$, $V_{DS} = - 80\text{ V}$, see fig. 6 and 13 ^b	-	-	18	nC
Gate-Source Charge	Q_{gs}			-	-	3.0	
Gate-Drain Charge	Q_{gd}			-	-	9.0	
Turn-On Delay Time	$t_{d(on)}$	$V_{DD} = - 50\text{ V}$, $I_D = - 6.8\text{ A}$, $R_G = 18\text{ }\Omega$, $R_D = 7.1\text{ }\Omega$, see fig. 10 ^b		-	9.6	-	ns
Rise Time	t_r			-	29	-	
Turn-Off Delay Time	$t_{d(off)}$			-	21	-	
Fall Time	t_f			-	25	-	
Internal Drain Inductance	L_D	Between lead, 6 mm (0.25") from package and center of die contact		-	4.5	-	nH
Internal Source Inductance	L_S			-	7.5	-	

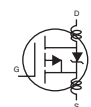

SPECIFICATIONS $T_J = 25^\circ\text{C}$, unless otherwise noted							
PARAMETER	SYMBOL	TEST CONDITIONS	MIN.	TYP.	MAX.	UNIT	
Drain-Source Body Diode Characteristics							
Continuous Source-Drain Diode Current	I_S	MOSFET symbol showing the integral reverse p - n junction diode 	-	-	- 5.6	A	
Pulsed Diode Forward Current ^a	I_{SM}		-	-	- 22		
Body Diode Voltage	V_{SD}	$T_J = 25^\circ\text{C}$, $I_S = -5.6\text{ A}$, $V_{GS} = 0\text{ V}^b$	-	-	- 6.3	V	
Body Diode Reverse Recovery Time	t_{rr}	$T_J = 25^\circ\text{C}$, $I_F = -6.8\text{ A}$, $di/dt = 100\text{ A}/\mu\text{s}^b$	-	100	200	ns	
Body Diode Reverse Recovery Charge	Q_{rr}		-	0.33	0.66	μC	
Forward Turn-On Time	t_{on}	Intrinsic turn-on time is negligible (turn-on is dominated by L_S and L_D)					

Notes

- a. Repetitive rating; pulse width limited by maximum junction temperature (see fig. 11).
- b. Pulse width $\leq 300\ \mu\text{s}$; duty cycle $\leq 2\%$.

TYPICAL CHARACTERISTICS 25°C , unless otherwise noted

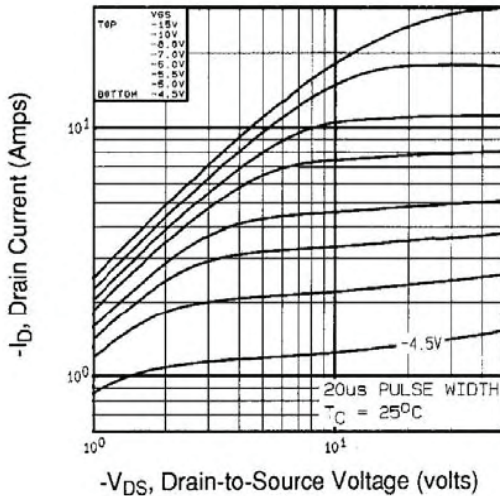

Fig. 1 - Typical Output Characteristics, $T_C = 25^\circ\text{C}$

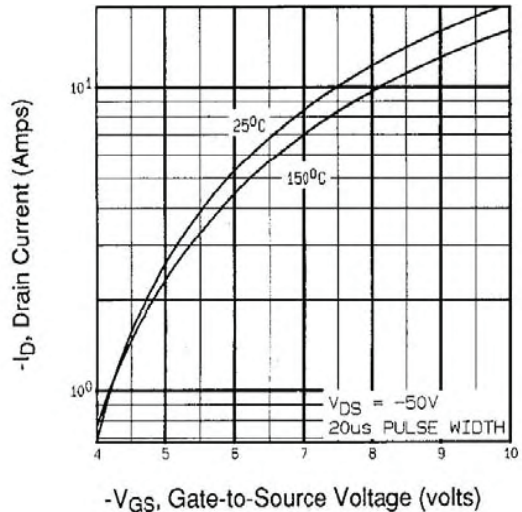

Fig. 3 - Typical Transfer Characteristics

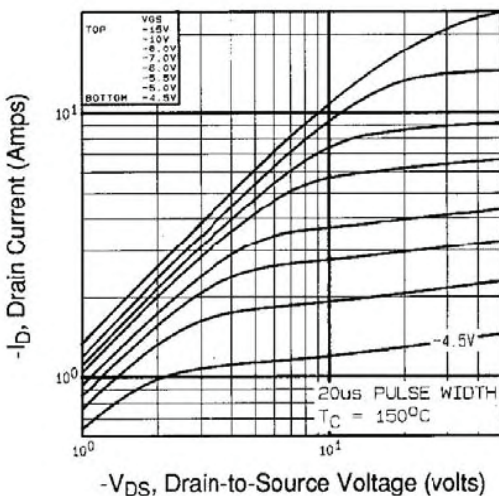

Fig. 2 - Typical Output Characteristics, $T_C = 150^\circ\text{C}$

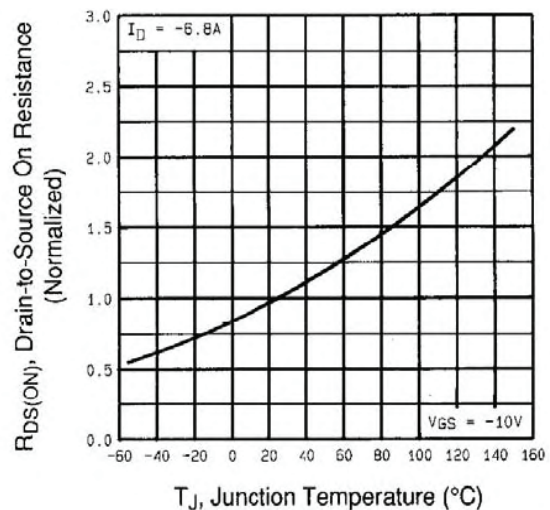

Fig. 4 - Normalized On-Resistance vs. Temperature

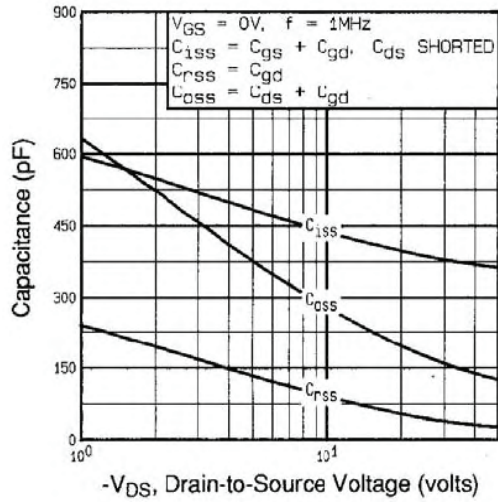

Fig. 5 - Typical Capacitance vs. Drain-to-Source Voltage

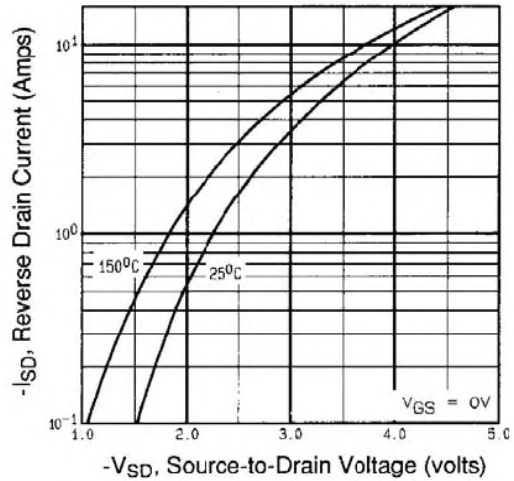

Fig. 7 - Typical Source-Drain Diode Forward Voltage

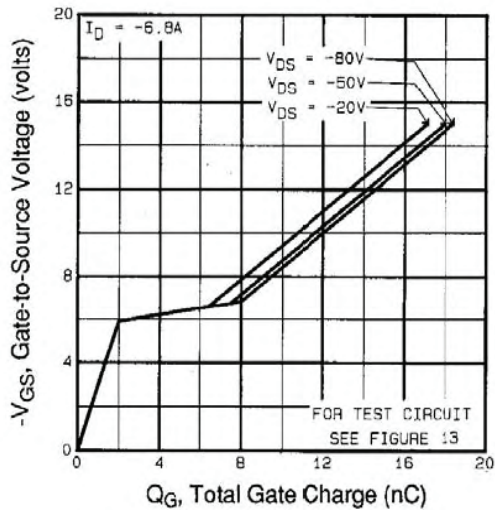

Fig. 6 - Typical Gate Charge vs. Gate-to-Source Voltage

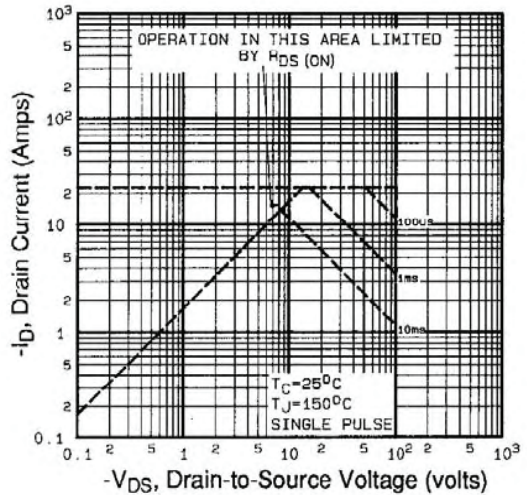

Fig. 8 - Maximum Safe Operating Area

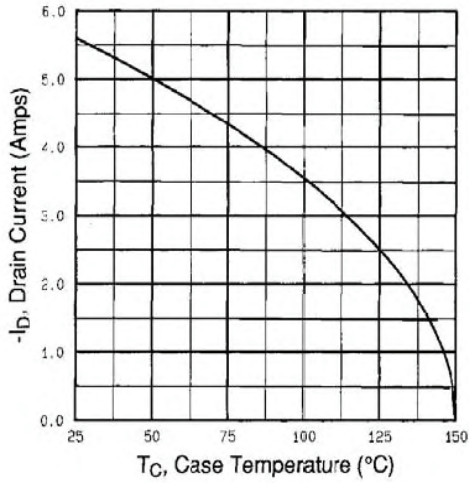

Fig. 9 - Maximum Drain Current vs. Case Temperature

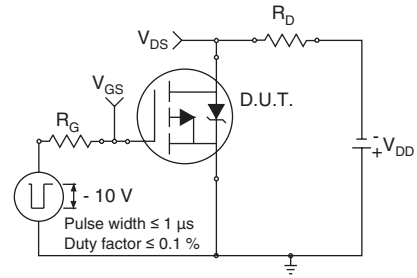

Fig. 10a - Switching Time Test Circuit

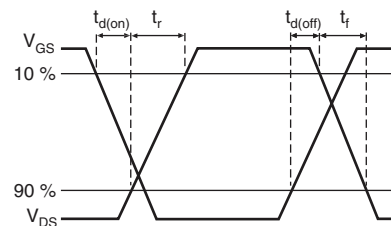

Fig. 10b - Switching Time Waveforms

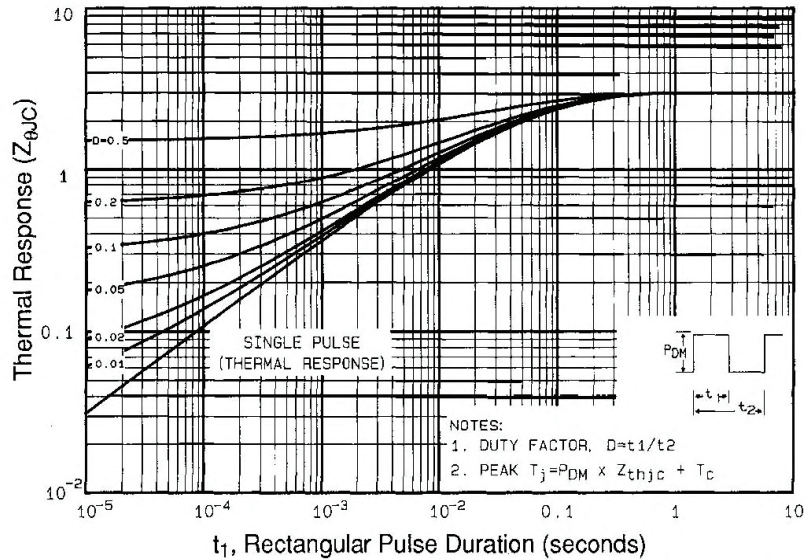

Fig. 11 - Maximum Effective Transient Thermal Impedance, Junction-to-Case

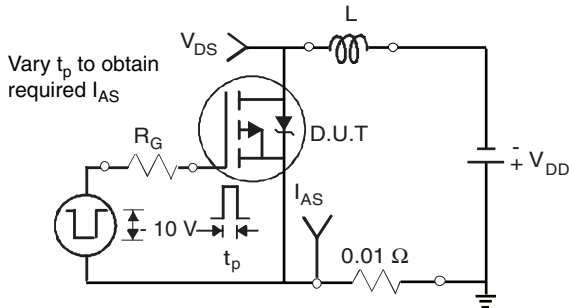

Fig. 12a - Unclamped Inductive Test Circuit

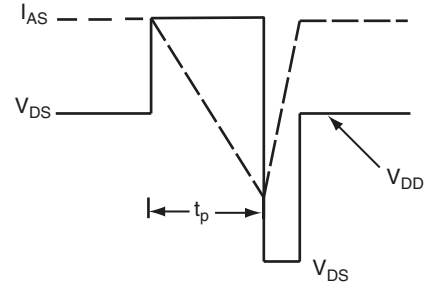

Fig. 12b - Unclamped Inductive Waveforms

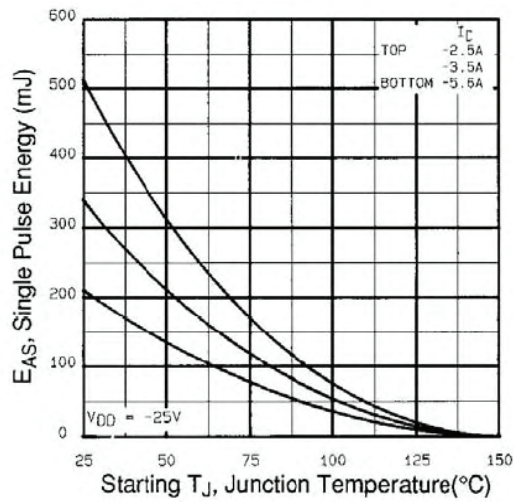

Fig. 12c - Maximum Avalanche Energy vs. Drain Current

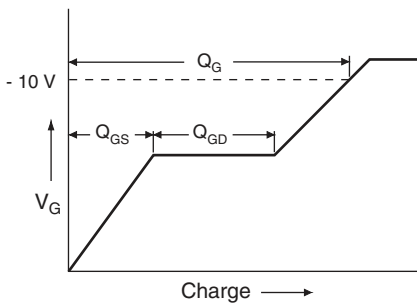

Fig. 13a - Basic Gate Charge Waveform

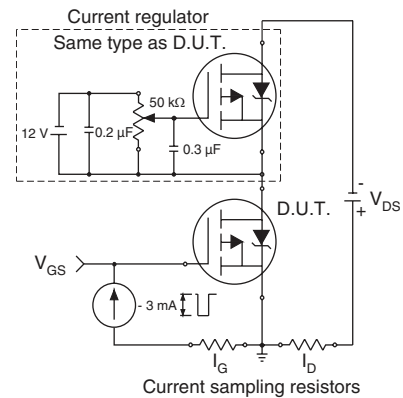
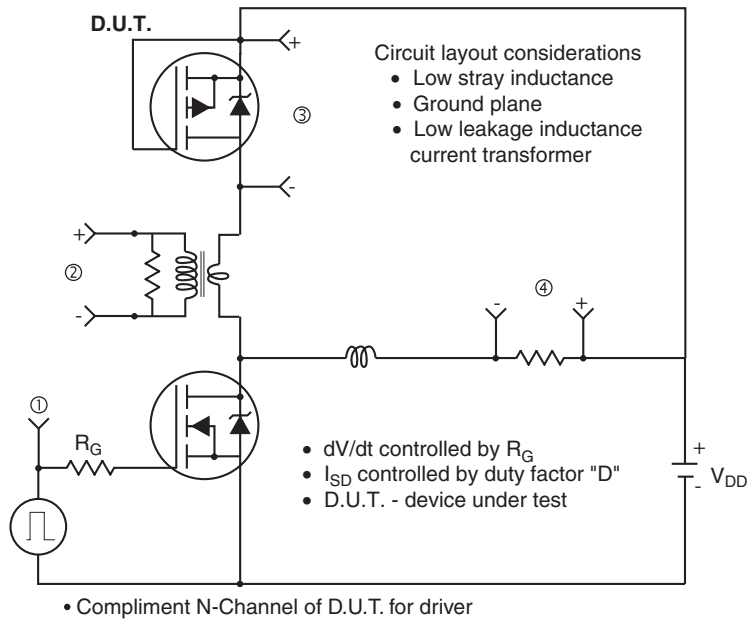

Fig. 13b - Gate Charge Test Circuit

Peak Diode Recovery dV/dt Test Circuit



* $V_{GS} = -5\text{ V}$ for logic level and -3 V drive devices

Fig. 14 - For P-Channel

Vishay Siliconix maintains worldwide manufacturing capability. Products may be manufactured at one of several qualified locations. Reliability data for Silicon Technology and Package Reliability represent a composite of all qualified locations. For related documents such as package/tape drawings, part marking, and reliability data, see <http://www.vishay.com/ppg?91280>.



Disclaimer

All product specifications and data are subject to change without notice.

Vishay Intertechnology, Inc., its affiliates, agents, and employees, and all persons acting on its or their behalf (collectively, "Vishay"), disclaim any and all liability for any errors, inaccuracies or incompleteness contained herein or in any other disclosure relating to any product.

Vishay disclaims any and all liability arising out of the use or application of any product described herein or of any information provided herein to the maximum extent permitted by law. The product specifications do not expand or otherwise modify Vishay's terms and conditions of purchase, including but not limited to the warranty expressed therein, which apply to these products.

No license, express or implied, by estoppel or otherwise, to any intellectual property rights is granted by this document or by any conduct of Vishay.

The products shown herein are not designed for use in medical, life-saving, or life-sustaining applications unless otherwise expressly indicated. Customers using or selling Vishay products not expressly indicated for use in such applications do so entirely at their own risk and agree to fully indemnify Vishay for any damages arising or resulting from such use or sale. Please contact authorized Vishay personnel to obtain written terms and conditions regarding products designed for such applications.

Product names and markings noted herein may be trademarks of their respective owners.