

IRGP20B120UD-EP

INSULATED GATE BIPOLAR TRANSISTOR WITH ULTRAFAST SOFT RECOVERY DIODE

UltraFast CoPack IGBT

Features

- UltraFast Non Punch Through (NPT) Technology
- Low Diode V_F (1.67V Typical @ 20A & 25°C)
- 10 μ s Short Circuit Capability
- Square RBSOA
- UltraSoft Diode Recovery Characteristics
- Positive $V_{CE(on)}$ Temperature Coefficient
- Extended Lead TO-247AD Package

Benefits

- Benchmark Efficiency Above 20KHz
- Optimized for Welding, UPS, and Induction Heating Applications
- Rugged with UltraFast Performance
- Low EMI
- Significantly Less Snubber Required
- Excellent Current Sharing in Parallel Operation
- Longer Leads for Easier Mounting

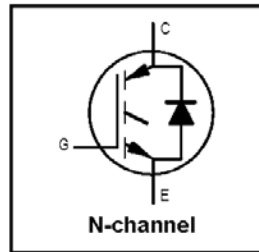

$V_{CES} = 1200V$
$V_{CE(on)} \text{ typ.} = 3.05V$
$V_{GE} = 15V, I_C = 20A, 25^\circ C$

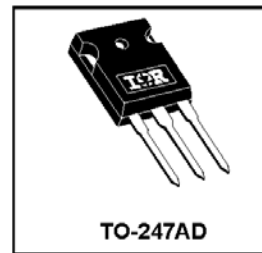

Absolute Maximum Ratings

	Parameter	Max.	Units
V_{CES}	Collector-to-Emitter Breakdown Voltage	1200	V
$I_C @ T_C = 25^\circ C$	Continuous Collector Current (Fig.1)	40	A
$I_C @ T_C = 100^\circ C$	Continuous Collector Current (Fig.1)	20	
I_{CM}	Pulsed Collector Current (Fig.3, Fig. CT.5)	120	
I_{LM}	Clamped Inductive Load Current (Fig.4, Fig. CT.2)	120	
$I_F @ T_C = 100^\circ C$	Diode Continuous Forward Current	20	
I_{FM}	Diode Maximum Forward Current	120	V
V_{GE}	Gate-to-Emitter Voltage	± 20	
$P_D @ T_C = 25^\circ C$	Maximum Power Dissipation (Fig.2)	300	W
$P_D @ T_C = 100^\circ C$	Maximum Power Dissipation (Fig.2)	120	
T_J	Operating Junction and	-55 to + 150	°C
T_{STG}	Storage Temperature Range		
	Soldering Temperature, for 10 seconds	300, (0.063 in. (1.6mm) from case)	
	Mounting Torque, 6-32 or M3 screw.	10 lbf-in (1.1N-m)	

Thermal Resistance

	Parameter	Min.	Typ.	Max.	Units
$R_{\theta JC}$	Junction-to-Case - IGBT	---	---	0.42	°C/W
$R_{\theta JC}$	Junction-to-Case - Diode	---	---	0.83	
$R_{\theta CS}$	Case-to-Sink, flat, greased surface	---	0.24	---	
$R_{\theta JA}$	Junction-to-Ambient, typical socket mount	---	---	40	
W_t	Weight	---	6 (0.21)	---	g (oz)
$Z_{\theta JC}$	Transient Thermal Impedance Junction-to-Case (Fig.24)				

Electrical Characteristics @ T_J = 25°C (unless otherwise specified)

	Parameter	Min.	Typ.	Max.	Units	Conditions	Fig.
V _{(BR)CES}	Collector-to-Emitter Breakdown Voltage	1200			V	V _{GE} = 0V, I _c = 250 μA	
ΔV _{(BR)CES} / ΔT _J	Temperature Coeff. of Breakdown Voltage		+1.2		V/°C	V _{GE} = 0V, I _c = 1 mA (25 - 125 °C)	
V _{CE(on)}	Collector-to-Emitter Saturation Voltage		3.05	3.45	V	I _c = 20A, V _{GE} = 15V	6.6
			3.37	3.80		I _c = 25A, V _{GE} = 15V	7.9
			4.23	4.85		I _c = 40A, V _{GE} = 15V	10
			3.89	4.50		I _c = 20A, V _{GE} = 15V, T _J = 125°C	11
			4.31	5.06		I _c = 25A, V _{GE} = 15V, T _J = 125°C	
V _{GE(th)}	Gate Threshold Voltage	4.0	5.0	6.0	V	V _{CE} = V _{GE} , I _c = 250 μA	9,10,11,12
ΔV _{GE(th)} / ΔT _J	Temperature Coeff. of Threshold Voltage		- 1.2		mV/°C	V _{CE} = V _{GE} , I _c = 1 mA (25 - 125 °C)	
g _{fe}	Forward Transconductance	13.6	15.7	17.8	S	V _{CE} = 50V, I _c = 20A, PW=80μs	
I _{CES}	Zero Gate Voltage Collector Current			250	μA	V _{GE} = 0V, V _{CE} = 1200V	
			420	750		V _{GE} = 0V, V _{CE} = 1200V, T _J = 125°C	
			1482	2200		V _{GE} = 0V, V _{CE} = 1200V, T _J = 150°C	
V _{FM}	Diode Forward Voltage Drop		1.67	1.96	V	I _c = 20A	8
			1.76	2.06		I _c = 25A	
			1.73	2.03		I _c = 20A, T _J = 125°C	
			1.87	2.18		I _c = 25A, T _J = 125°C	
I _{GES}	Gate-to-Emitter Leakage Current			±100	nA	V _{GE} = ±20V	

Switching Characteristics @ T_J = 25°C (unless otherwise specified)

	Parameter	Min.	Typ.	Max.	Units	Conditions	Fig.
Q _g	Total Gate charge (turn-on)		169	254	nC	I _c = 20A	23
Q _{ge}	Gate - Emitter Charge (turn-on)		24	36		V _{CC} = 600V	CT1
Q _{gc}	Gate - Collector Charge (turn-on)		82	126		V _{GE} = 15V	
E _{on}	Turn-On Switching Loss		850	1050	μJ	I _c = 20A, V _{CC} = 600V	CT4
E _{off}	Turn-Off Switching Loss		425	650		V _{GE} = 15V, R _g = 5Ω, L = 200μH	WF1
E _{tot}	Total Switching Loss		1275	1800		T _J = 25°C, Energy losses include tail and diode reverse recovery	WF2
E _{on}	Turn-on Switching Loss		1350	1550	μJ	I _c = 20A, V _{CC} = 600V	13, 16
E _{off}	Turn-off Switching Loss		610	875		V _{GE} = 15V, R _g = 5Ω, L = 200μH	CT4
E _{tot}	Total Switching Loss		1960	2425		T _J = 125°C, Energy losses include tail and diode reverse recovery	WF1 & 2
td(on)	Turn - on delay time		50	65	ns	I _c = 20A, V _{CC} = 600V	14, 16
tr	Rise time		20	30		V _{GE} = 15V, R _g = 5Ω, L = 200μH	CT4
td(off)	Turn - off delay time		204	230		T _J = 125°C	WF1
tf	Fall time		24	35			WF2
C _{ies}	Input Capacitance		2200		pF	V _{GE} = 0V	22
C _{oes}	Output Capacitance		210			V _{CC} = 30V	
C _{res}	Reverse Transfer Capacitance		85			f = 1.0 MHz	
RBSOA	Reverse bias safe operating area	FULL SQUARE				T _J = 150°C, I _c = 120A V _{CC} = 1000V, V _P = 1200V R _g = 5Ω, V _{GE} = +15V to 0V	4 CT2
SCSOA	Short Circuit Safe Operating Area	10	----	----	μs	T _J = 150°C V _{CC} = 900V, V _P = 1200V R _g = 5Ω, V _{GE} = +15V to 0V	CT3 WF4
E _{rec}	Reverse recovery energy of the diode		1600	2100	μJ	T _J = 125°C	17,18,19
t _{rr}	Diode Reverse recovery time		300		ns	V _{CC} = 600V, I _c = 20A	20, 21
I _{rr}	Peak Reverse Recovery Current		32	36	A	V _{GE} = 15V, R _g = 5Ω, L = 200μH	CT4, WF3
L _e	Internal Emitter Inductance		13		nH	Measured 5 mm from the package.	

Fig.1 - Maximum DC Collector Current vs. Case Temperature

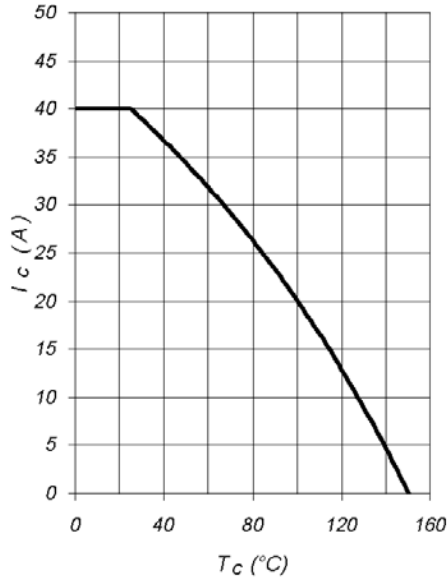

Fig.2 - Power Dissipation vs. Case Temperature

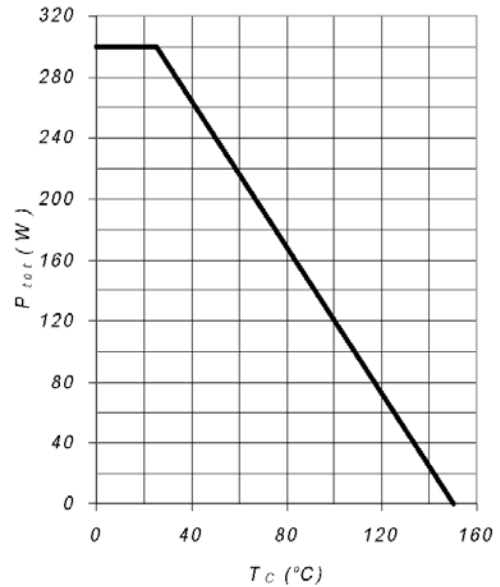

Fig.3 - Forward SOA
 $T_C=25^\circ\text{C}; T_J \leq 150^\circ\text{C}$

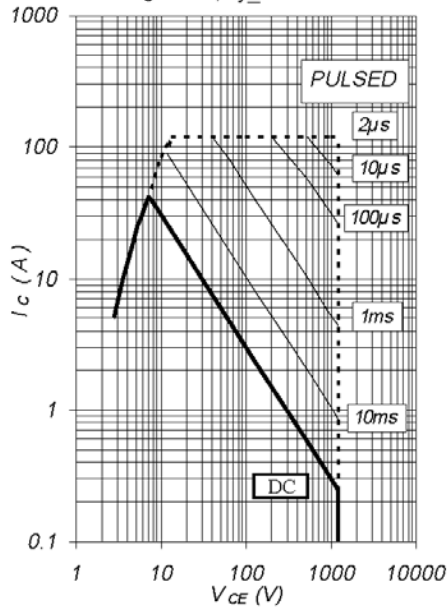

Fig.4 - Reverse Bias SOA
 $T_J = 150^\circ\text{C}, V_{GE} = 15\text{V}$

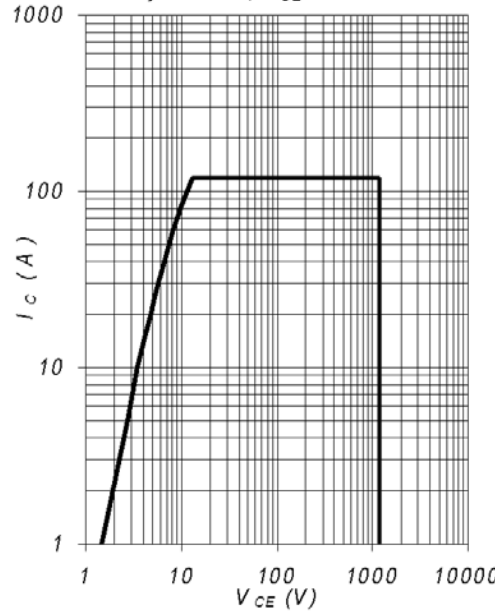

Fig.5 - Typical IGBT Output Characteristics
 $T_j = -40^\circ\text{C}; t_p = 300\mu\text{s}$

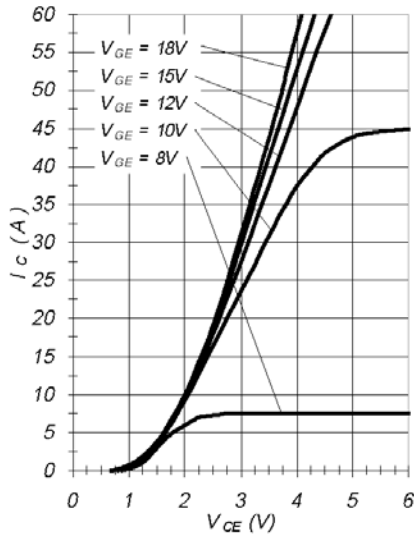

Fig.6 - Typical IGBT Output Characteristics
 $T_j = 25^\circ\text{C}; t_p = 300\mu\text{s}$

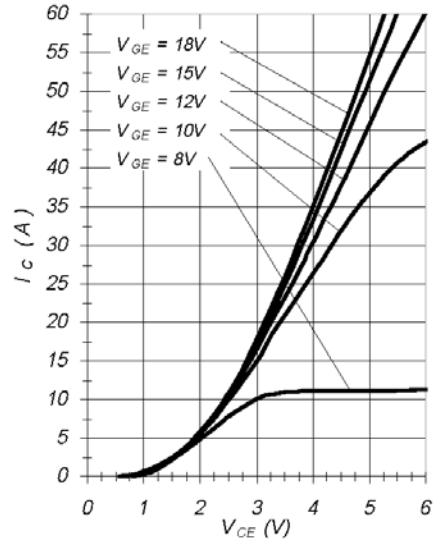

Fig.7 - Typical IGBT Output Characteristics
 $T_j = 125^\circ\text{C}; t_p = 300\mu\text{s}$

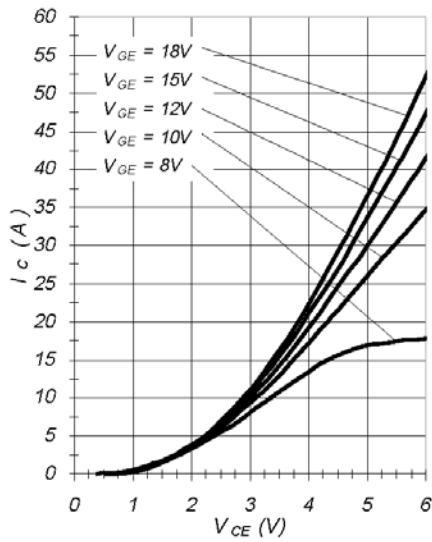

Fig.8 - Typical Diode Forward Characteristic
 $t_p = 300\mu\text{s}$

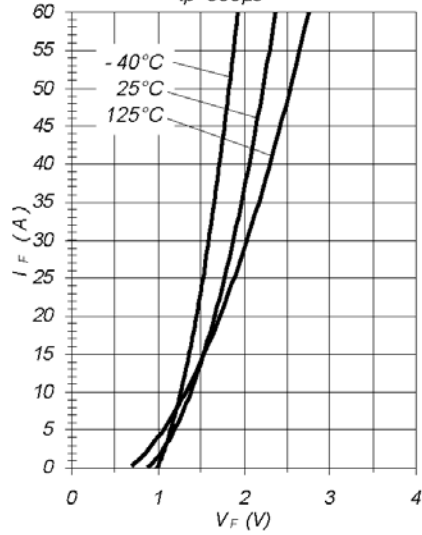

Fig.9 - Typical V_{CE} vs V_{GE}
 $T_j = -40^\circ\text{C}$

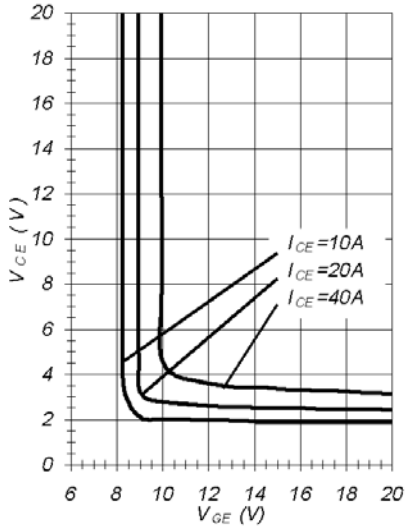

Fig.10 - Typical V_{CE} vs V_{GE}
 $T_j = 25^\circ\text{C}$

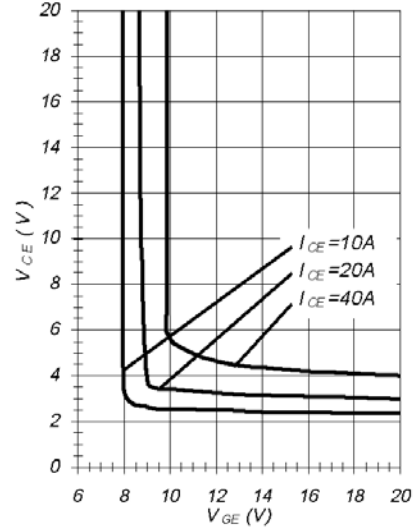

Fig.11 - Typical V_{CE} vs V_{GE}
 $T_j = 125^\circ\text{C}$

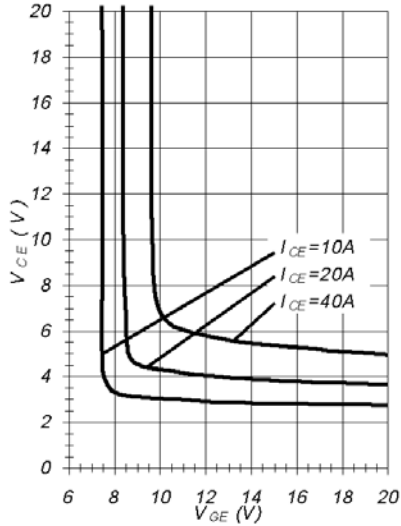

Fig.12 - Typ. Transfer Characteristics
 $V_{CE} = 20\text{V}$; $t_p = 20\mu\text{s}$

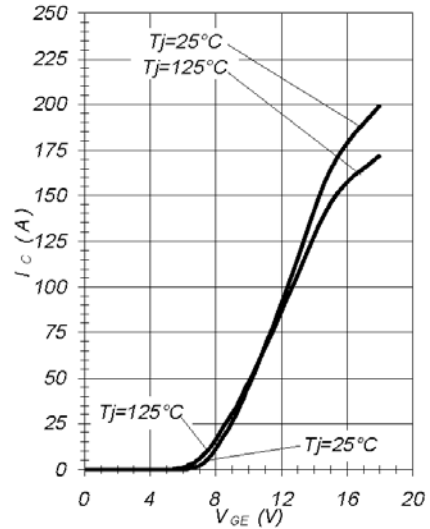

Fig.13 - Typical Energy Loss vs I_C
 $T_j=125^\circ\text{C}$; $L=200\mu\text{H}$; $V_{CE}=600\text{V}$;
 $R_g=22\Omega$; $V_{GE}=15\text{V}$

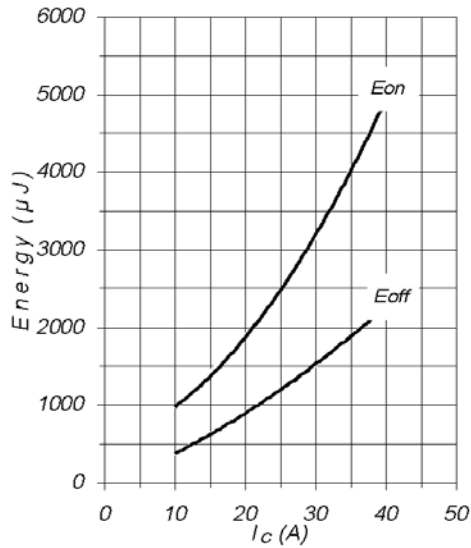

Fig.14 - Typical Switching Time vs I_C
 $T_j=125^\circ\text{C}$; $L=200\mu\text{H}$; $V_{CE}=600\text{V}$;
 $R_g=22\Omega$; $V_{GE}=15\text{V}$

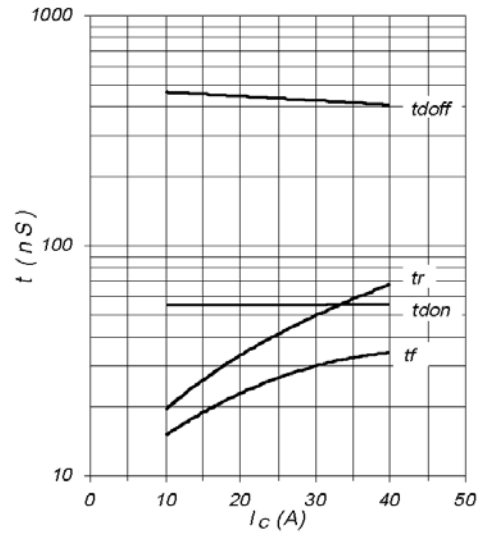

Fig.15 - Typical Energy Loss vs R_g
 $T_j=125^\circ\text{C}$; $L=200\mu\text{H}$; $V_{CE}=600\text{V}$;
 $I_{CE}=20\text{A}$; $V_{GE}=15\text{V}$

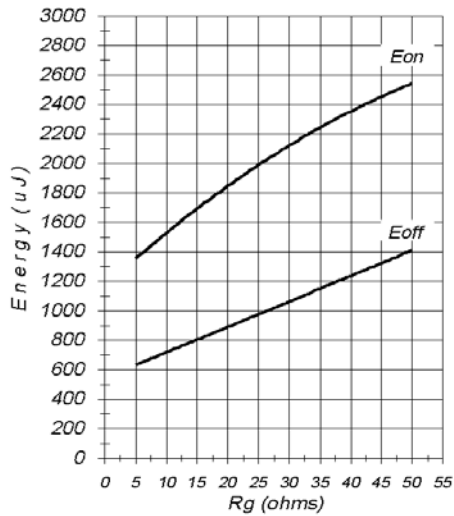

Fig.16 - Typical Switching Time vs R_g
 $T_j=125^\circ\text{C}$; $L=200\mu\text{H}$; $V_{CE}=600\text{V}$;
 $I_{CE}=20\text{A}$; $V_{GE}=15\text{V}$

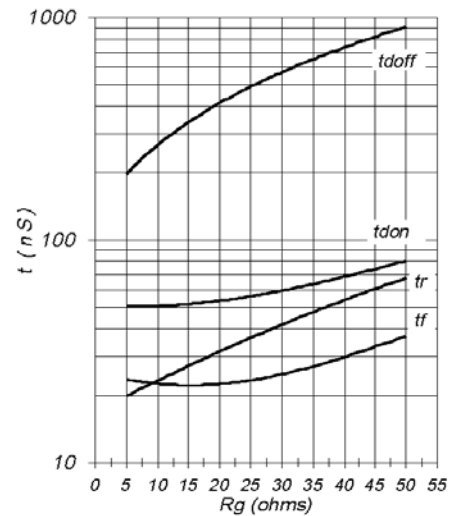

Fig.17 - Typical Diode I_{RR} vs I_F
 $T_j=125^\circ\text{C}$

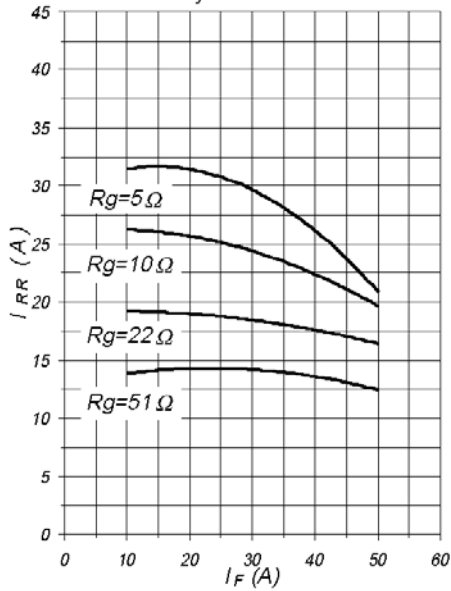

Fig.18 - Typical Diode I_{RR} vs R_g
 $T_j=125^\circ\text{C}; I_F=20\text{A}$

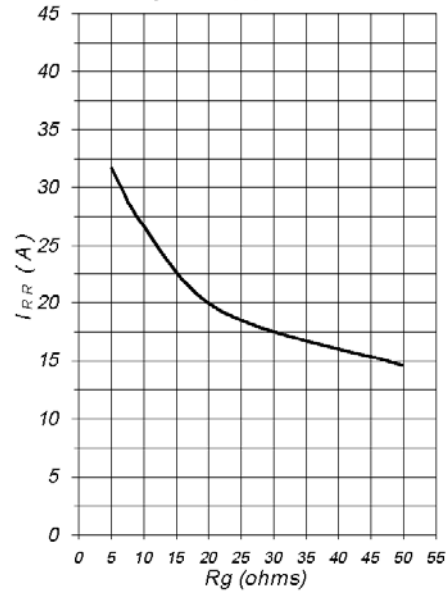

Fig.19 - Typical Diode I_{RR} vs di_F/dt
 $V_{CC}=600\text{V}; V_{GE}=15\text{V}$
 $I_F=20\text{A}; T_j=125^\circ\text{C}$

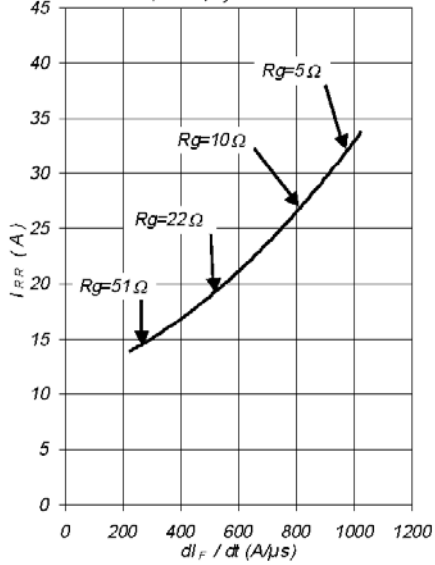
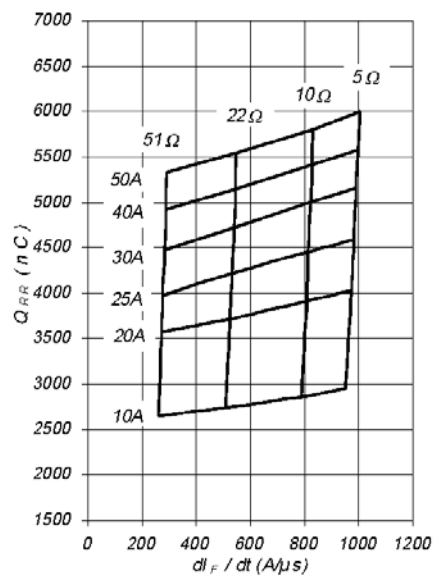

Fig.20 - Typical Diode Q_{RR}
 $V_{CC}=600\text{V}; V_{GE}=15\text{V}; T_j=125^\circ\text{C}$



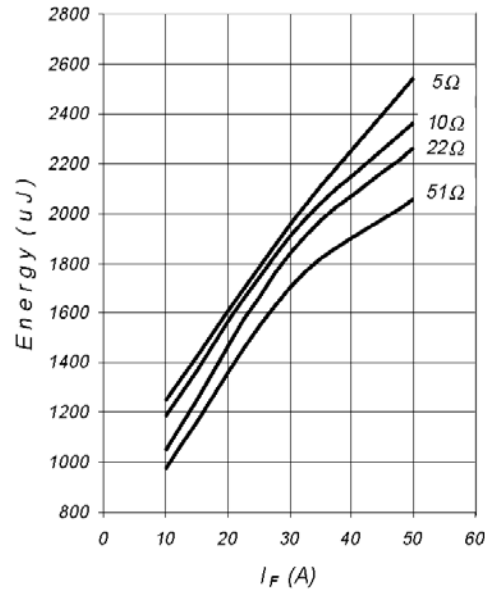

Fig.22 - Typical Capacitance vs V_{CE}
 $V_{GE}=0V$; $f=1MHz$

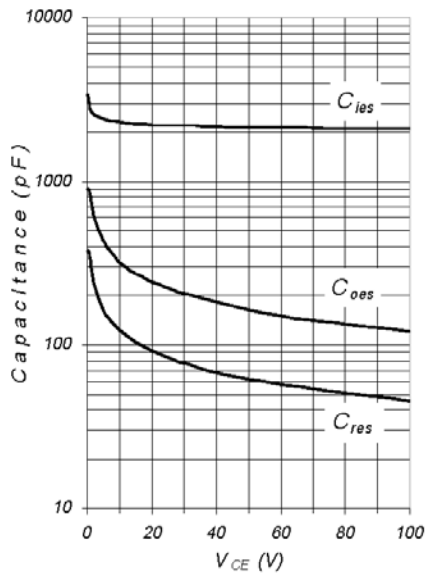

Fig.23 - Typ. Gate Charge vs. V_{GE}
 $I_C=20A$; $L=600\mu H$

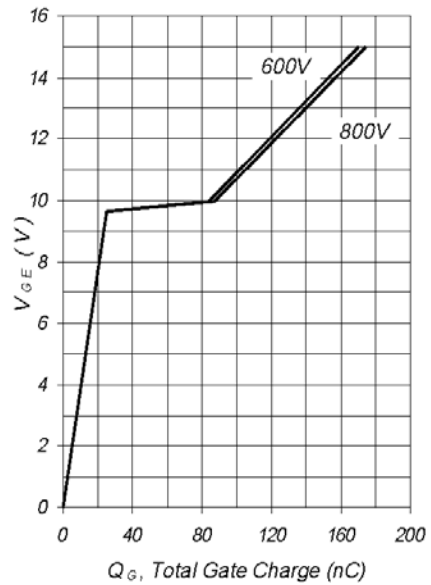

Fig.24 - Normalized Transient Thermal Impedance, Junction-to-Case

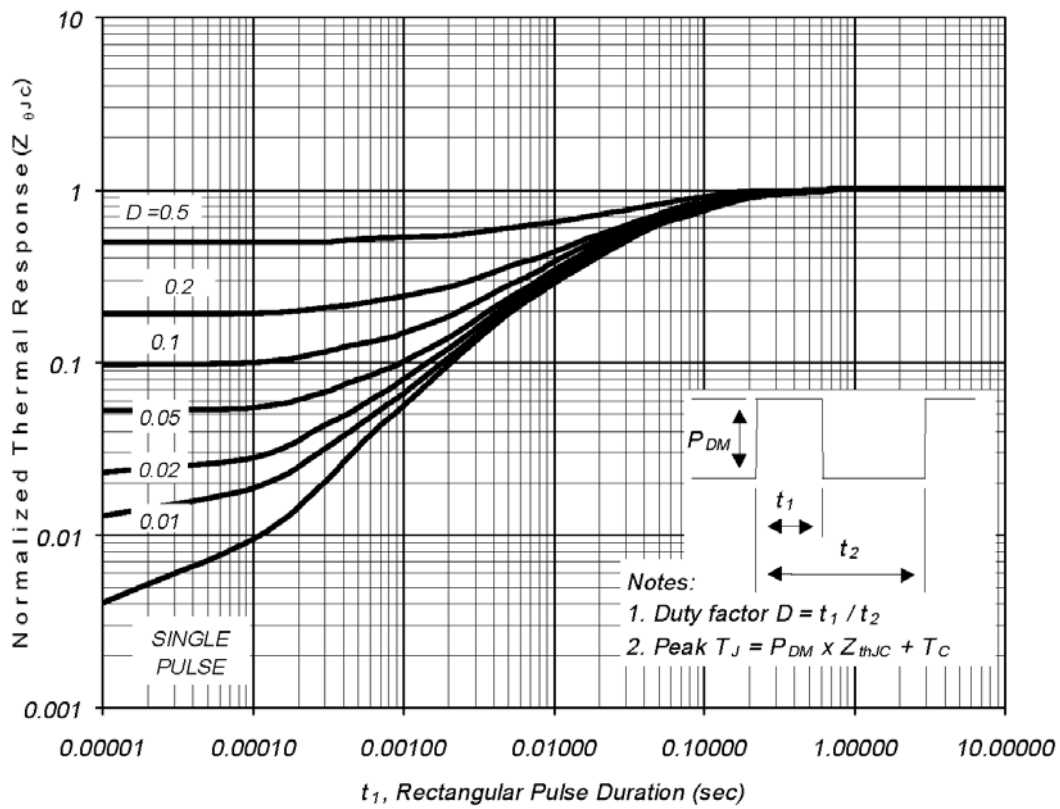

Fig. CT.1 - Gate Charge Circuit (turn-off)

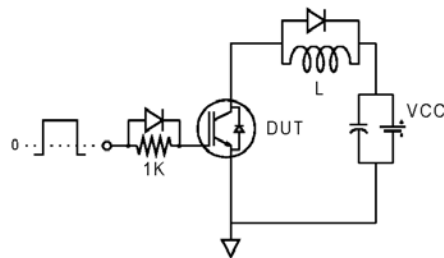

Fig. CT.2 - RBSOA Circuit

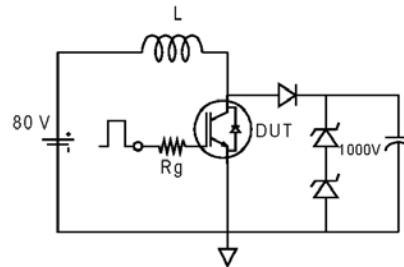

Fig. CT.3 - S.C. SOA Circuit

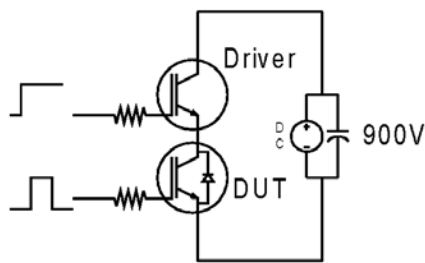

Fig. CT.4 - Switching Loss Circuit

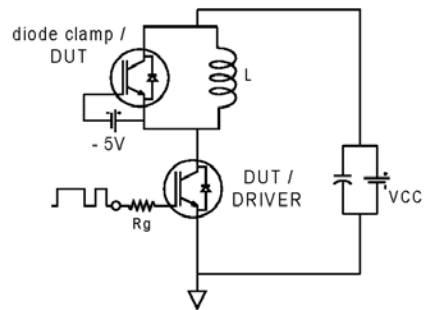

Fig. CT.5 - Resistive Load Circuit

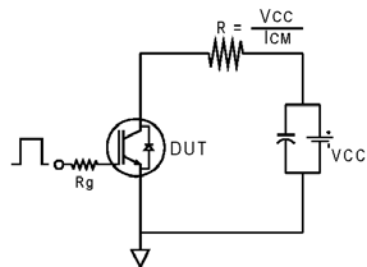

Fig. WF.1 - Typ. Turn-off Loss Waveform
@ $T_j=125^\circ\text{C}$ using Fig. CT.4

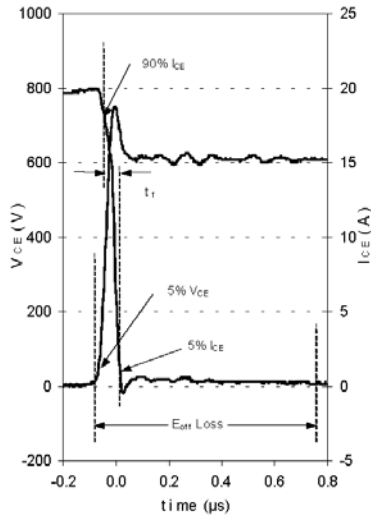

Fig. WF.2 - Typ. Turn-on Loss Waveform
@ $T_j=125^\circ\text{C}$ using Fig. CT.4

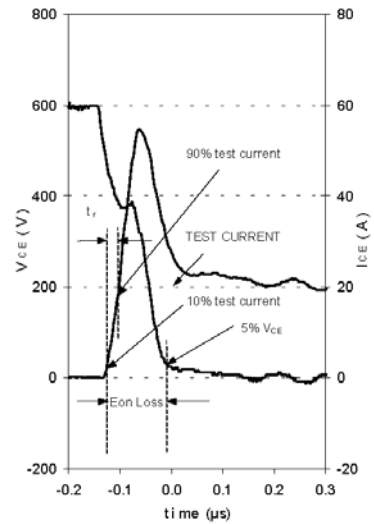

Fig. WF.3 - Typ. Diode Recovery Waveform
@ $T_j=125^\circ\text{C}$ using Fig. CT.4

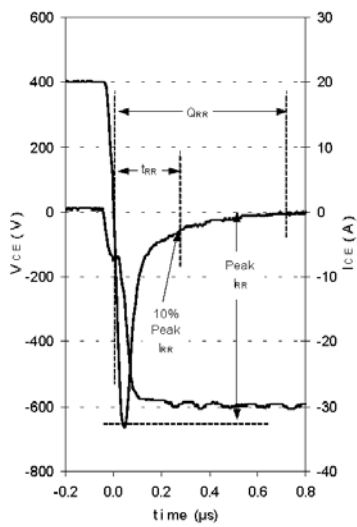
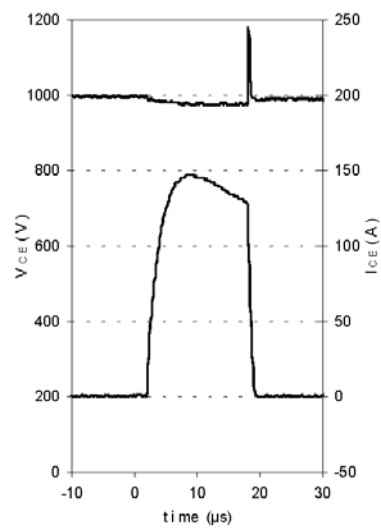

Fig. WF.4 - Typ. S.C. Waveform
@ $T_C=150^\circ\text{C}$ using Fig. CT.3



IRGP20B120UD-EP

International
IR Rectifier

TO-247AD Package Outline

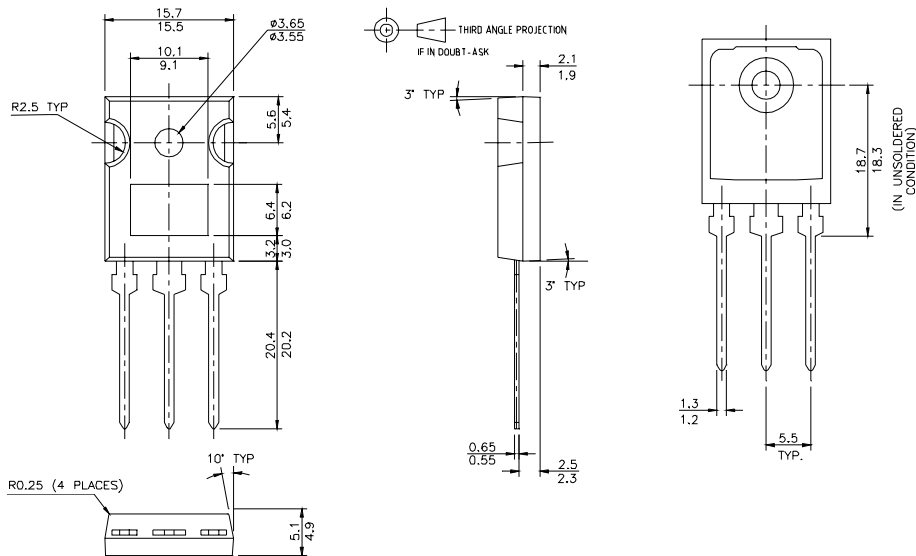

TO-247AD Part Marking Information

EXAMPLE: THIS IS AN IRGP30B120KD-E
WITH ASSEMBLY
LOT CODE 5657
ASSEMBLED ON WW 35, 2000
IN THE ASSEMBLY LINE "H"

Note: "P" in assembly line position
indicates "Lead-Free"

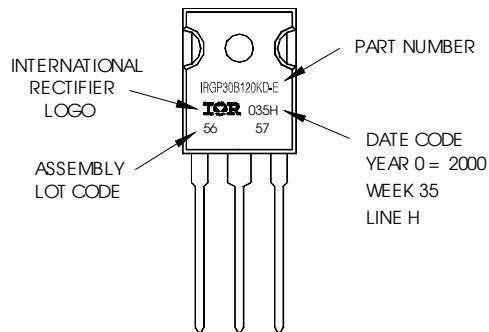

Data and specifications subject to change without notice.

International
IR Rectifier

IR WORLD HEADQUARTERS: 233 Kansas St., El Segundo, California 90245, USA Tel: (310) 252-7105
TAC Fax: (310) 252-7903

Visit us at www.irf.com for sales contact information.07/04

www.irf.com