

IRLBD59N04E

HEXFET® Power MOSFET

- Integrated Temperature Sensing Diode
- Ultra Low On-Resistance
- Dynamic dv/dt Rating
- 175°C Operating Temperature
- Fully Avalanche Rated
- Zener Gate Protected

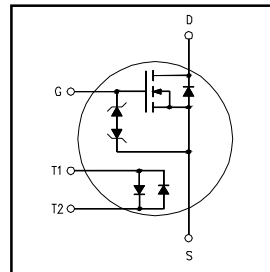

$V_{DSS} = 40V$
$R_{DS(on)} = 0.018\Omega$
$I_D = 59A\text{⑤}$

Description

The IRLBD59N04E is a 40V, N-channel HEXFET® power MOSFET with gate protection provided by integrated back to back zener diodes. Temperature sensing is given by the change in forward voltage drop of two antiparallel electrically isolated poly-silicon diodes.

The IRLBD59N04E provides cost effective temperature sensing for system protection along with the quality and ruggedness you expect from a HEXFET power MOSFET.

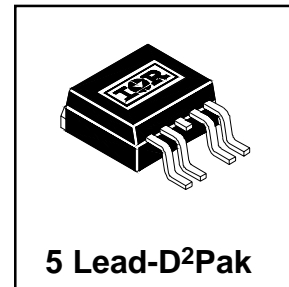

Absolute Maximum Ratings

	Parameter	Max.	Units
$I_D @ T_C = 25^\circ C$	Continuous Drain Current, $V_{GS} @ 10V$	59⑥	A
$I_D @ T_C = 100^\circ C$	Continuous Drain Current, $V_{GS} @ 10V$	41	
I_{DM}	Pulsed Drain Current ①	230	
$P_D @ T_C = 25^\circ C$	Power Dissipation	130	W
	Linear Derating Factor	0.89	W/°C
V_{GS}	Gate-to-Source Voltage	± 10	V
E_{AS}	Single Pulse Avalanche Energy②	340	mJ
I_{AR}	Avalanche Current①	35	A
E_{AR}	Repetitive Avalanche Energy①	13	mJ
dv/dt	Peak Diode Recovery dv/dt ③	3.6	V/ns
I_G	V_{GS} Clamp Current	± 50	mA
V_{ESD}	Electrostatic Voltage Rating④	± 2.0	kV
T_J	Operating Junction and	-55 to + 175	°C
T_{STG}	Storage Temperature Range		
	Soldering Temperature, for 10 seconds	300 (1.6mm from case)	
	Mounting torque, 6-32 or M3 screw	10 lbf•in (1.1N•m)	

Thermal Resistance

	Parameter	Typ.	Max.	Units
$R_{\theta JC}$	Junction-to-Case	—	1.12	°C/W
$R_{\theta JA}$	Junction-to-Ambient (PCB Mounted,steady-state)**	—	40	

Electrical Characteristics @ T_J = 25°C (unless otherwise specified)

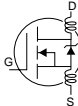
	Parameter	Min.	Typ.	Max.	Units	Conditions
V _{(BR)DSS}	Drain-to-Source Breakdown Voltage	40	—	—	V	V _{GS} = 0V, I _D = 250μA
ΔV _{(BR)DSS} /ΔT _J	Breakdown Voltage Temp. Coefficient	—	0.044	—	V/°C	Reference to 25°C, I _D = 1mA
R _{DS(on)}	Static Drain-to-Source On-Resistance	—	—	0.018	Ω	V _{GS} = 10V, I _D = 35A ④
		—	—	0.021		V _{GS} = 5.0V, I _D = 30A ④
V _{GS(th)}	Gate Threshold Voltage	1.0	—	2.0	V	V _{DS} = V _{GS} , I _D = 250μA
V _{GS}	Clamp Voltage	10	—	20	V	I _{GSS} = 20μA
g _{fs}	Forward Transconductance	29	—	—	S	V _{DS} = 25V, I _D = 35A
I _{DSS}	Drain-to-Source Leakage Current	—	—	25	μA	V _{DS} = 40V, V _{GS} = 0V
		—	—	250		V _{DS} = 32V, V _{GS} = 0V, T _J = 150°C
I _{GSS}	Gate-to-Source Forward Leakage	—	—	1.0	μA	V _{GS} = 5.0V
	Gate-to-Source Reverse Leakage	—	—	-1.0		V _{GS} = -5.0V
Q _g	Total Gate Charge	—	—	50	nC	I _D = 35A
Q _{gs}	Gate-to-Source Charge	—	—	13		V _{DS} = 32V
Q _{gd}	Gate-to-Drain ("Miller") Charge	—	—	18		V _{GS} = 5.0V, See Fig. 6 and 13 ④
t _{d(on)}	Turn-On Delay Time	—	7.8	—	ns	V _{DD} = 20V
t _r	Rise Time	—	84	—		I _D = 35A
t _{d(off)}	Turn-Off Delay Time	—	33	—		R _G = 5.1Ω,
t _f	Fall Time	—	67	—		V _{GS} = 5.0V, See Fig.10 ④
L _D	Internal Drain Inductance	—	2.0	—	nH	Between lead, 6mm (0.25in.) from package and center of die contact
L _S	Internal Source Inductance	—	5.0	—		
C _{iss}	Input Capacitance	—	2190	—	pF	V _{GS} = 0V
C _{oss}	Output Capacitance	—	670	—		V _{DS} = 25V
C _{rss}	Reverse Transfer Capacitance	—	130	—		f = 1.0MHz, See Fig. 5

Source-Drain Ratings and Characteristics

	Parameter	Min.	Typ.	Max.	Units	Conditions
I _S	Continuous Source Current (Body Diode)	—	—	59⑥	A	MOSFET symbol showing the integral reverse p-n junction diode.
I _{SM}	Pulsed Source Current (Body Diode) ①	—	—	230		
V _{SD}	Diode Forward Voltage	—	—	1.3	V	T _J = 25°C, I _S = 35A, V _{GS} = 0V ④
t _{rr}	Reverse Recovery Time	—	57	86	ns	T _J = 25°C, I _F = 35A
Q _{rr}	Reverse Recovery Charge	—	84	130	nC	di/dt = 100A/μs ④
t _{on}	Forward Turn-On Time	Intrinsic turn-on time is negligible (turn-on is dominated by L _S +L _D)				

Sense Diode Rating

	Parameter	Min.	Typ.	Max.	Units	Conditions
V _{FM}	Sense Diode Maximum Voltage Drop	675	—	725	mV	I _F = 250μA, T _J = 25°C
ΔV _F /ΔT _J	Sense Diode Temperature Coefficient	-1.30	-1.40	-1.58	mV/°C	I _F = 250μA, (T _J = 25°C and 160°C)

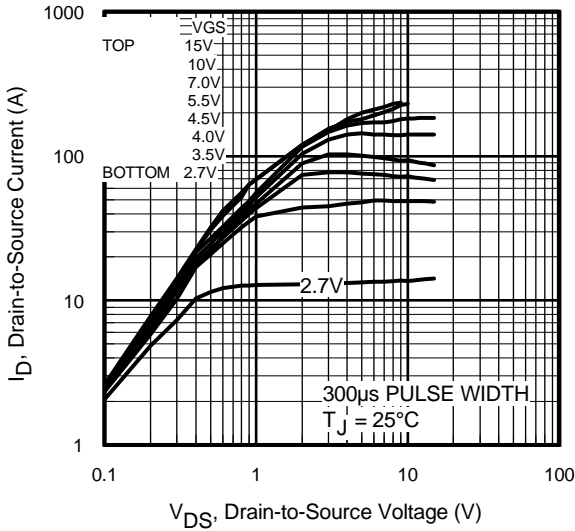

Fig 1. Typical Output Characteristics

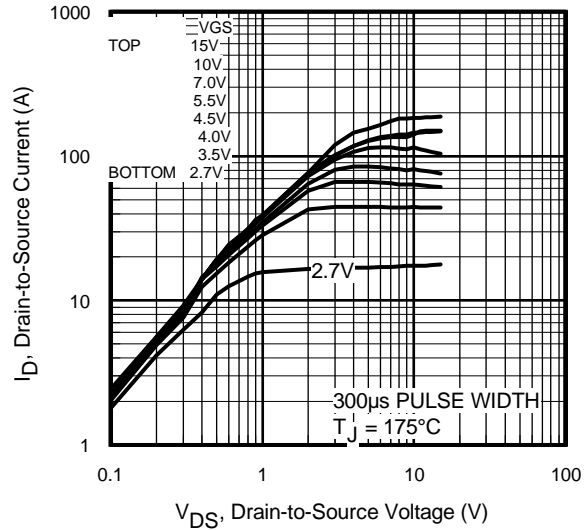

Fig 2. Typical Output Characteristics

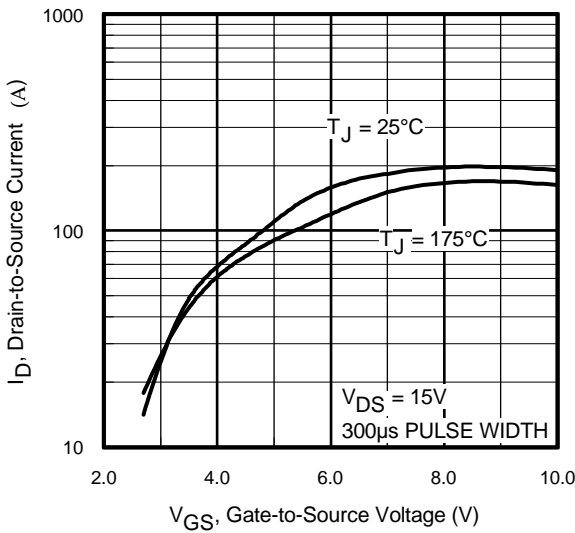

Fig 3. Typical Transfer Characteristics

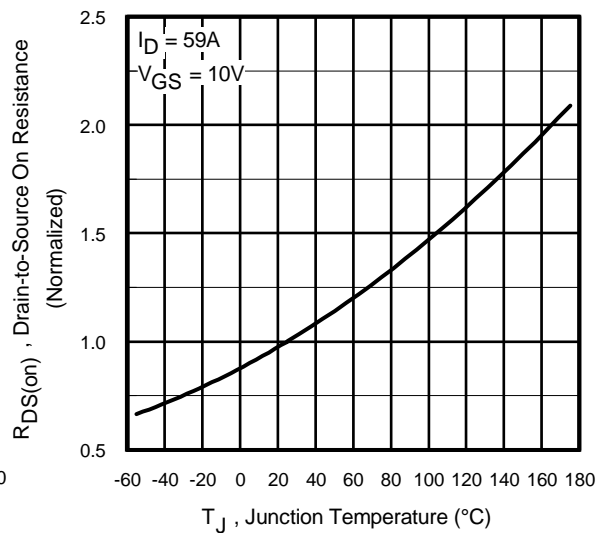

Fig 4. Normalized On-Resistance Vs. Temperature

IRLBD59N04E

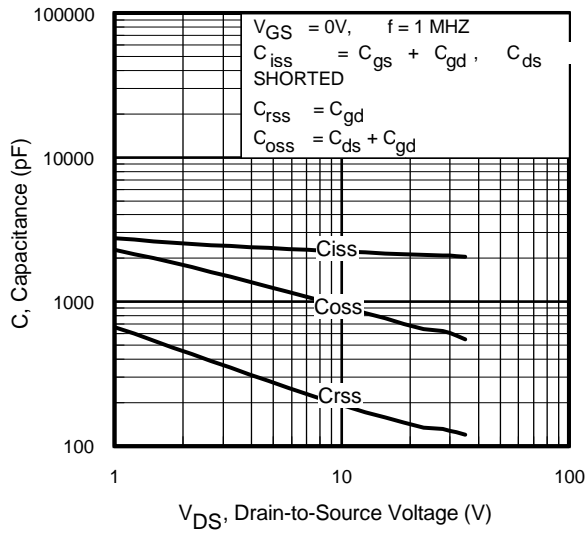

Fig 5. Typical Capacitance Vs. Drain-to-Source Voltage

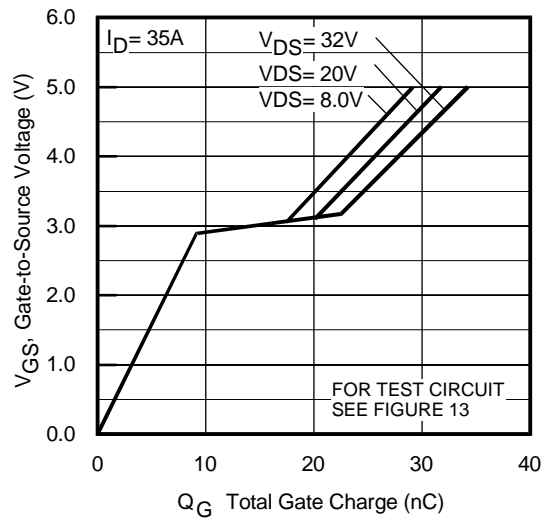

Fig 6. Typical Gate Charge Vs. Gate-to-Source Voltage

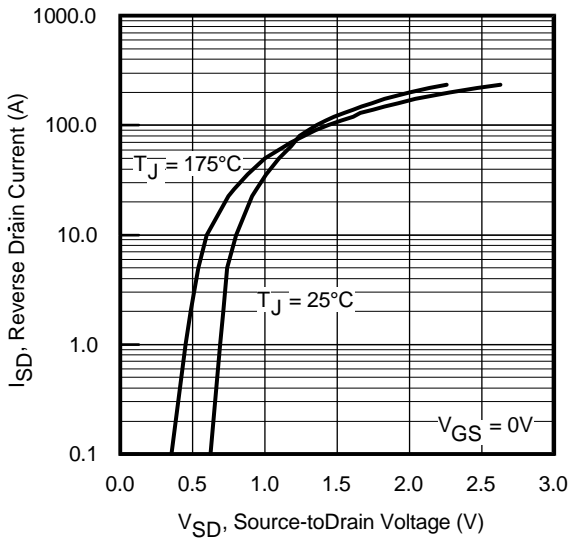

Fig 7. Typical Source-Drain Diode Forward Voltage

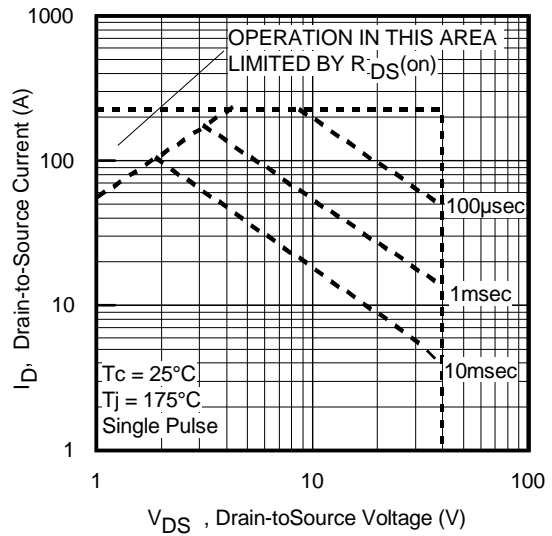

Fig 8. Maximum Safe Operating Area

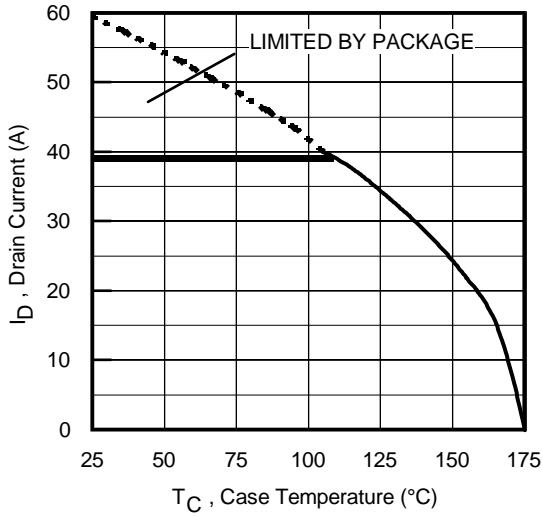

Fig 9. Maximum Drain Current Vs. Case Temperature

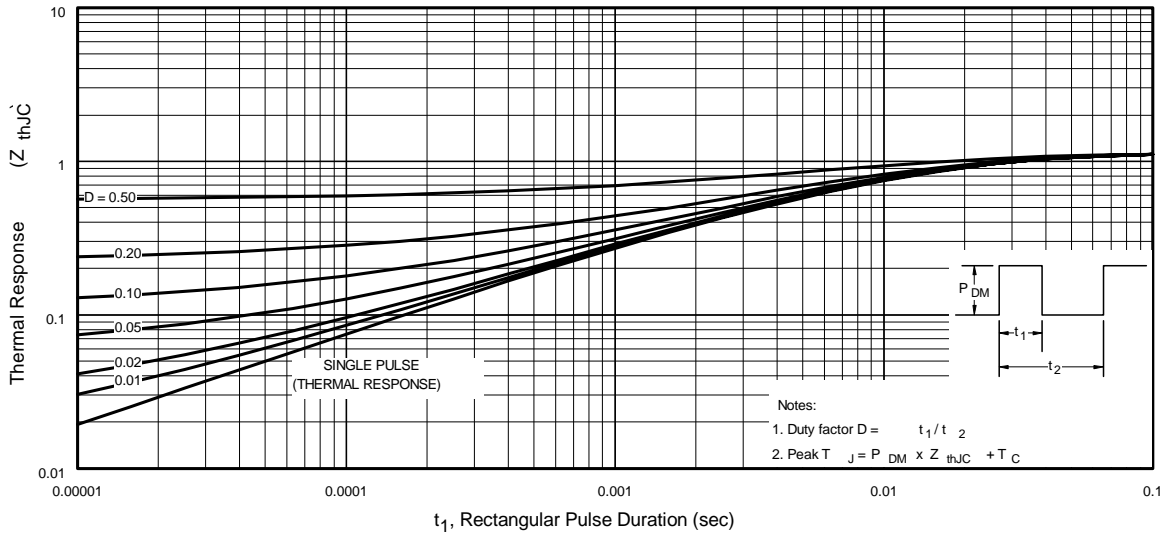
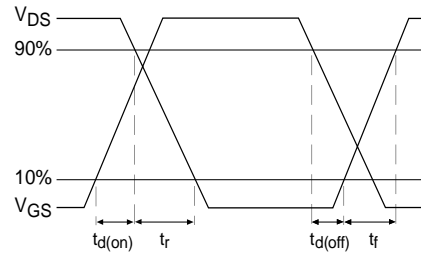
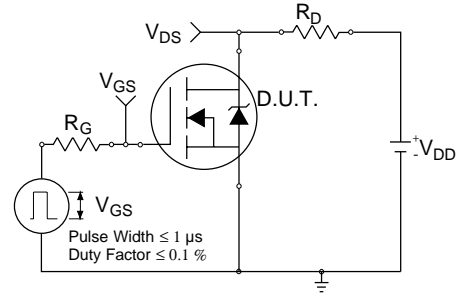

Fig 11. Maximum Effective Transient Thermal Impedance, Junction-to-Case

IRLBD59N04E

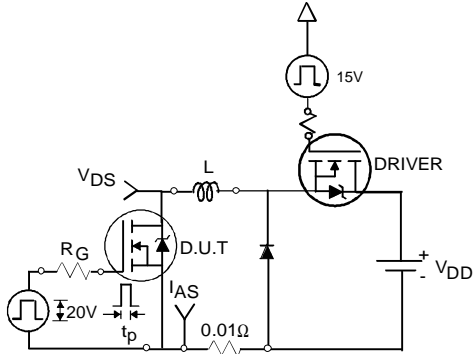

Fig 12a. Unclamped Inductive Test Circuit

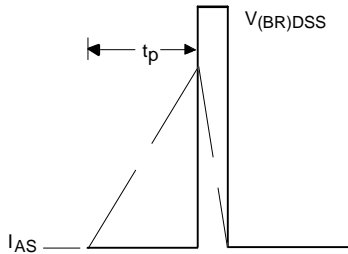

Fig 12b. Unclamped Inductive Waveforms

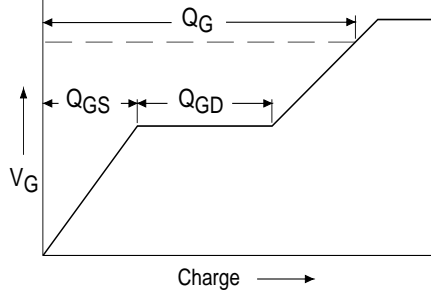

Fig 13a. Basic Gate Charge Waveform



Fig 13b. Gate Charge Test Circuit

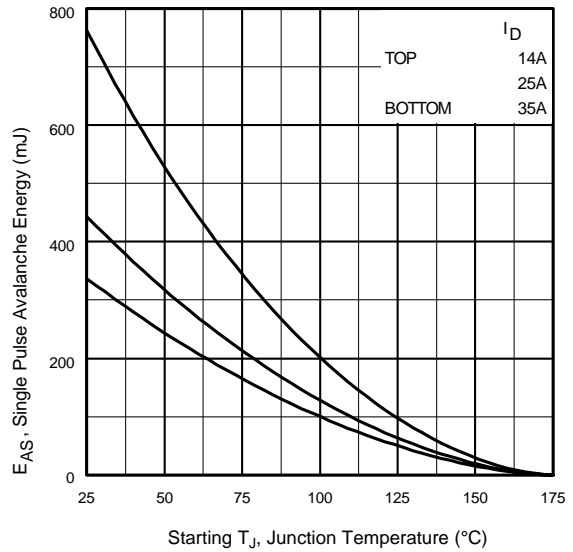

Fig 12c. Maximum Avalanche Energy Vs. Drain Current

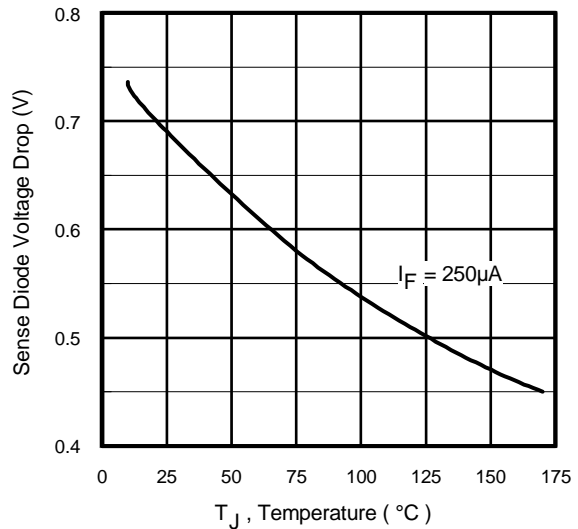
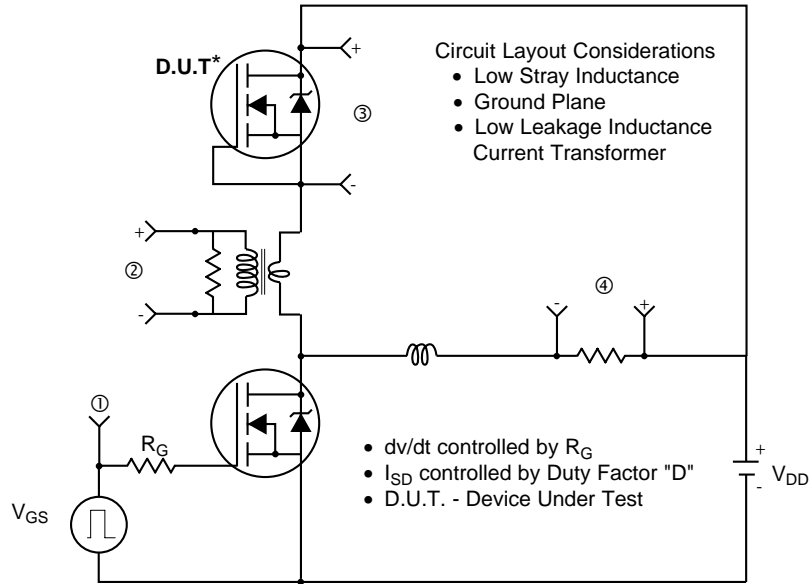
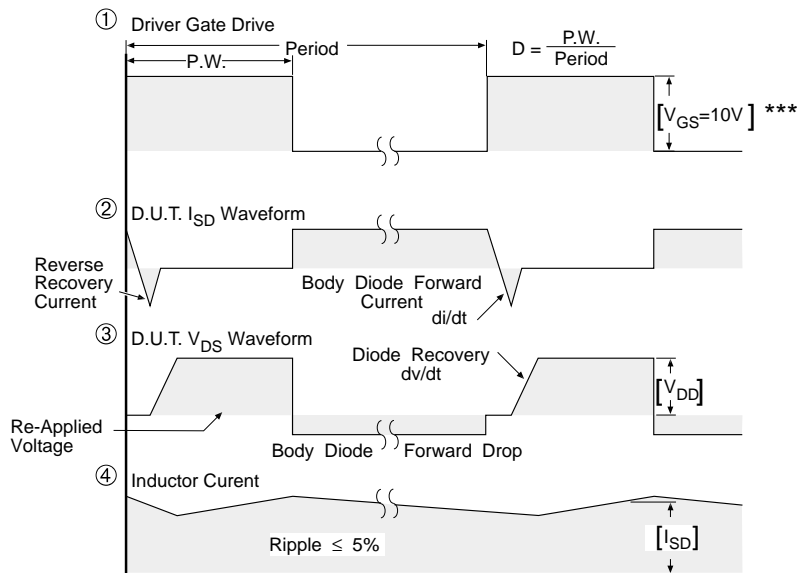

Fig 14. Sense Diode Voltage Drop Vs. Temperature

Peak Diode Recovery dv/dt Test Circuit



* Reverse Polarity of D.U.T for P-Channel



*** $V_{GS} = 5.0V$ for Logic Level and 3V Drive Devices

Fig 15. For N-channel HEXFET® power MOSFETs

IRLBD59N04E

International
IR Rectifier

Case Outline 5 Lead-D²Pak (SMD-220)

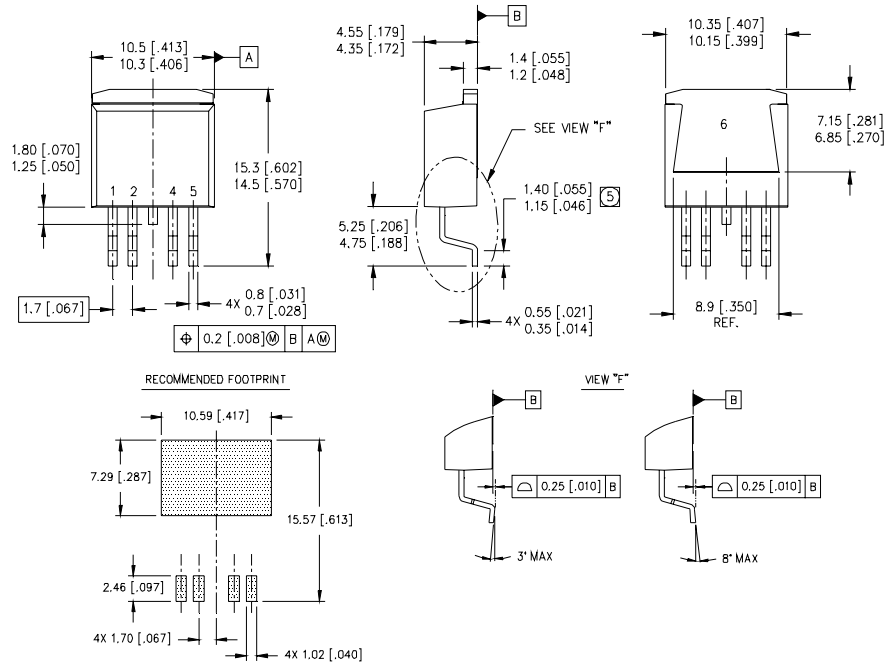

NOTES:

1. DIMENSIONING & TOLERANCING PER ASME Y14.5M-1994.
2. CONTROLLING DIMENSION: MILLIMETER.
3. DIMENSIONS ARE SHOWN IN MILLIMETERS [INCHES].
4. OUTLINE SIMILAR TO JEDEC OUTLINE SERIES TO-263.
- ⑤ DIMENSION IS THE LENGTH OF LEAD FOR SOLDERING TO A SUBSTRATE.

PIN ASSIGNMENTS

- 1 - G - GATE
- 2 - T1 - ANODE
- 3 - D - DRAIN
- 4 - T2 - CATHODE
- 5 - S - SOURCE

Notes:

- ① Repetitive rating; pulse width limited by max. junction temperature. (See fig. 11)
- ② Starting $T_J = 25^\circ\text{C}$, $L = 0.55\text{mH}$
 $R_G = 25\Omega$, $I_{AS} = 35\text{A}$. (See Figure 12)
- ③ $I_{SD} \leq 35\text{A}$, $di/dt \leq 150\text{A}/\mu\text{s}$, $V_{DD} \leq V_{(BR)DSS}$,
 $T_J \leq 175^\circ\text{C}$
- ④ Pulse width $\leq 400\mu\text{s}$; duty cycle $\leq 2\%$.
- ⑤ Calculated continuous current based on maximum allowable junction temperature. Package limitation current is 39A
- ⑥ $C = 100\text{pF}$, $R = 1.5\text{k}\Omega$

** When mounted on 1" square PCB (FR-4 or G-10 Material).
For recommended soldering techniques refer to application note #AN-994.

Data and specifications subject to change without notice.
This product has been designed and qualified for the Automotive [Q101] market.
Qualification Standards can be found on IR's Web site.

International
IR Rectifier

IR WORLD HEADQUARTERS: 233 Kansas St., El Segundo, California 90245, USA Tel: (310) 252-7105
TAC Fax: (310) 252-7903

Visit us at www.irf.com for sales contact information.11/01

www.irf.com