

PRODUCT SPECIFICATION

DATE : 01/20/2010

cosmo ELECTRONICS CORPORATION	Photocoupler : KP4010	NO.60P20017	REV.
		SHEET 1 OF 6	1

High Reliability Photocoupler

● Features

1. High current transfer ratio ($V_{ce0} : 300V \text{ min}$)
(CTR : Min. 600% at $I_F=1mA$ $V_{CE}=2V$)
2. High isolation voltage between input and output
(Viso : 5000Vrms)
3. Compact dual-in-line package.

● Application :

1. System appliances, measuring instruments.
2. Industrial robots.
3. Copiers, automatic vending machines.
4. Signal transmission between circuits of different potentials and impedances.
5. Telephone sets.
6. Copiers, facsimiles.
7. Interface with various power supply circuits, power distribution boards.
8. Numerical control machines.

PRODUCT SPECIFICATION

DATE : 01/20/2010

cosmo ELECTRONICS CORPORATION	Photocoupler : KP4010	NO.60P20017	REV. 1
		SHEET 2 OF 6	

● Outside Dimension : Unit (mm)

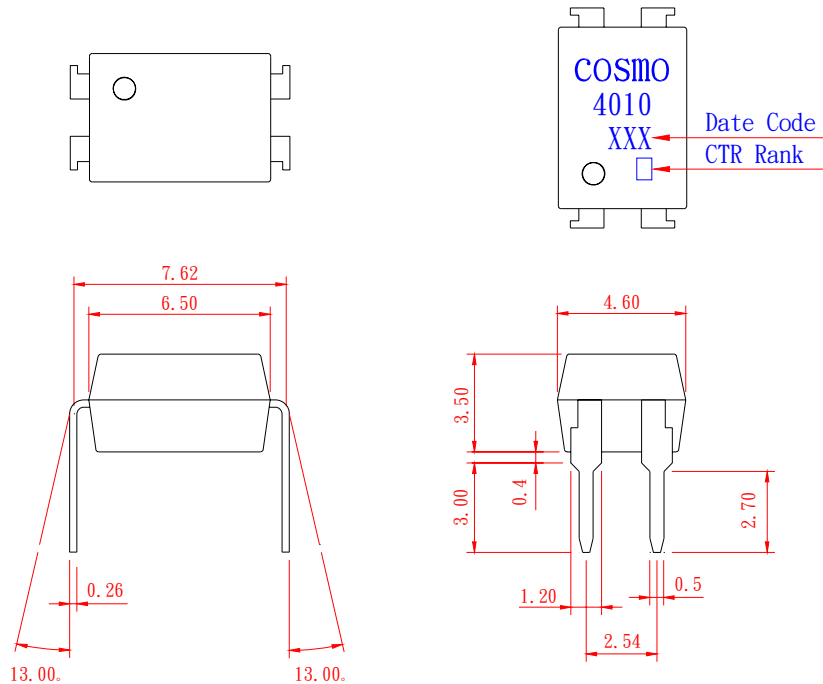

TOLERANCE : $\pm 0.2\text{mm}$

● Schematic : Top View

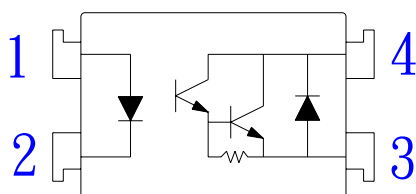

1. Anode
2. Cathode
3. Emitter
4. Collector

PRODUCT SPECIFICATION

DATE : 01/20/2010

cosmo ELECTRONICS CORPORATION	Photocoupler : KP4010	NO.60P20017	REV. 1
		SHEET 3 OF 6	

● Absolute Maximum Ratings

Parameter		Symbol	Rating	Unit
Input	Forward current	I_F	50	mA
	Peak forward current	I_{FM}	1	A
	Reverse voltage	V_R	6	V
	Power dissipation	P_D	70	mW
Output	Collector-emitter voltage	V_{CEO}	300	V
	Emitter-collector voltage	V_{ECO}	0.1	V
	Collector current	I_C	150	mA
	Collector power dissipation	P_C	200	mW
Total power dissipation		P_{tot}	200	mW
Isolation voltage 1 minute		V_{iso}	5000	Vrms
Operating temperature		T_{opr}	-55 to +100	°C
Storage temperature		T_{stg}	-55 to +125	°C
Soldering temperature 10 second		T_{sol}	260	°C

● Electro-optical Characteristics

Parameter		Symbol	Conditions	MIN.	TYP.	MAX.	Unit
Input	Forward voltage	V_F	$I_F=20mA$	-	1.2	1.4	V
	Peak forward voltage	V_{FM}	$I_{FM}=0.5A$	-	-	3.5	V
	Reverse current	I_R	$V_R=4V$	-	-	10	μA
	Terminal capacitance	C_t	$V=0, f=1KHz$	-	30	-	pF
Output	Collector dark current	I_{CEO}	$V_{CE}=200V$	-	-	1.0	μA
Transfer characteristics	Current transfer ratio	CTR	$I_F=1mA, V_{CE}=2V$	600	-	9000	%
	Collector-emitter saturation	$V_{CE(sat)}$	$I_F=20mA, I_C=5mA$	-	-	1.5	V
	Isolation resistance	R_{iso}	DC500V	5×10^{10}	-	-	Ω
	Floating capacitance	C_f	$V=0, f=1MHz$	-	0.6	1.0	pF
	Cut-off frequency	f_C	$V_{CC}=5V, I_C=2mA, R_L=100\Omega$	-	7	-	KHz
	Response time (Rise)	t_r	$V_{CE}=2V, I_C=20mA, R_L=100\Omega$	-	60	300	μs
	Response time (Fall)	t_f		-	50	250	μs

PRODUCT SPECIFICATION

DATE : 01/20/2010

cosmo
ELECTRONICS CORPORATION

Photocoupler :
KP4010

NO.60P20017
SHEET 4 OF 6

REV.
1

Classification table of current transfer ratio is shown below.

Model No.	CTR (%)
KP40101A	600 ~ 2000
KP40101B	1500 ~ 4000
KP40101C	3000 ~ 6000
KP40101D	5000 ~ 9000
KP40101E	600 ~ 9000

Fig.1 Current Transfer Ratio vs. Forward Current

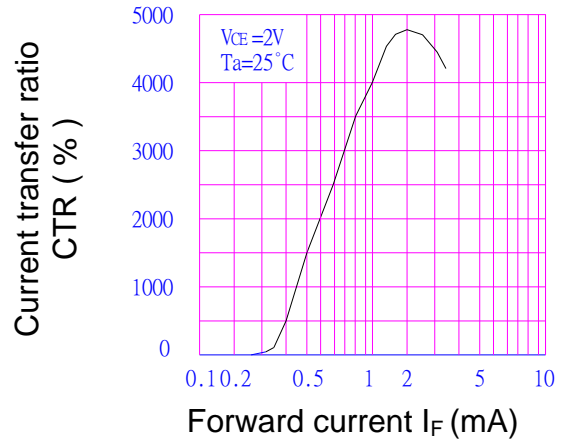

Fig.2 Collector Power Dissipation vs. Ambient Temperature

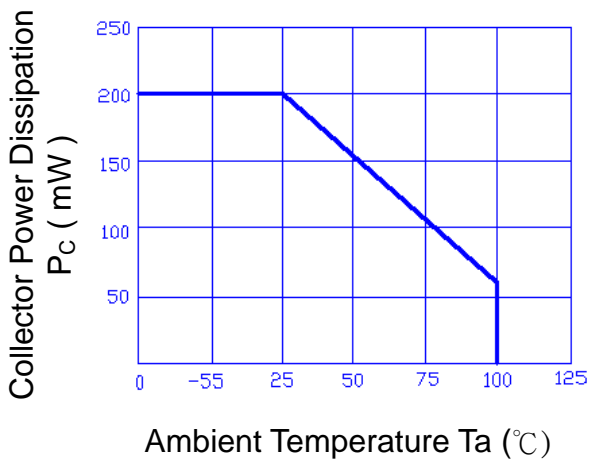

Fig.3 Collector Dark Current vs. Ambient Temperature

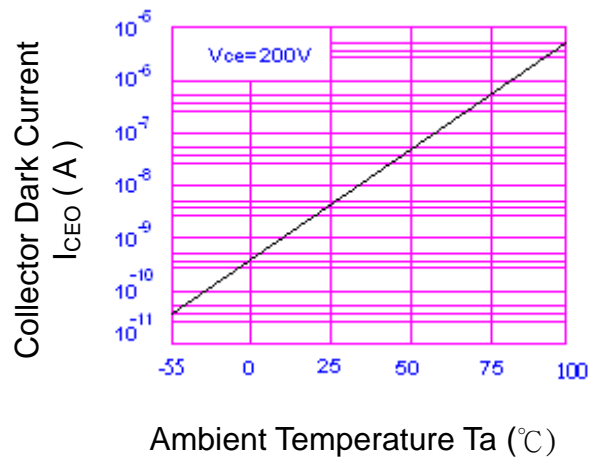

Fig.4 Forward Current vs. Ambient Temperature

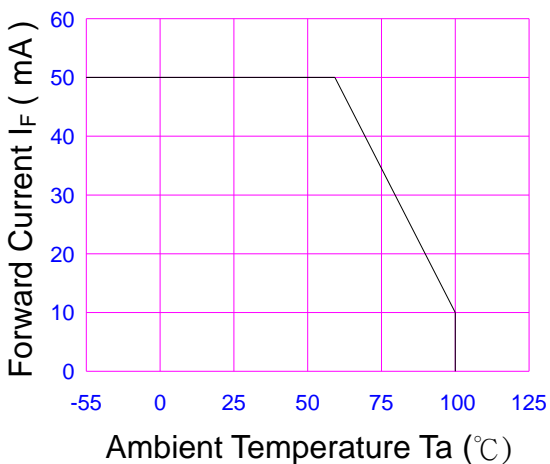
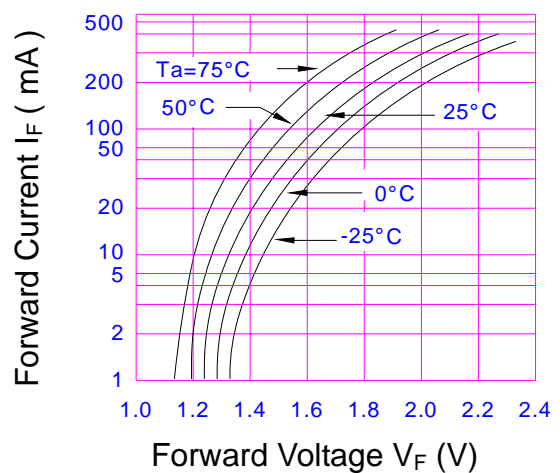

Fig.5 Forward Current vs. Forward Voltage



PRODUCT SPECIFICATION

DATE : 01/20/2010

cosmo
ELECTRONICS CORPORATION

Photocoupler :
KP4010

NO.60P20017
SHEET 5 OF 6

REV.
1

Fig.6 Collector Current vs. Collector-Emitter Voltage

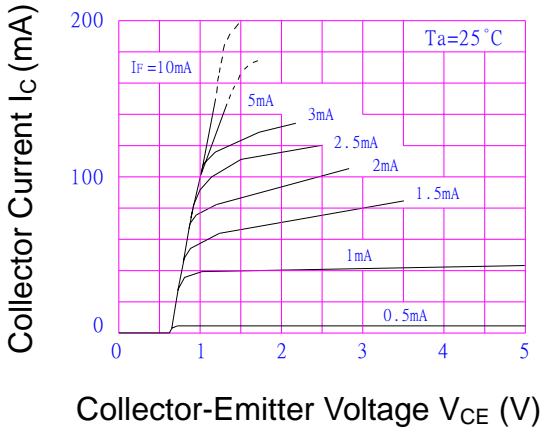

Fig.7 Relative Current Transfer Ratio vs. Ambient Temperature

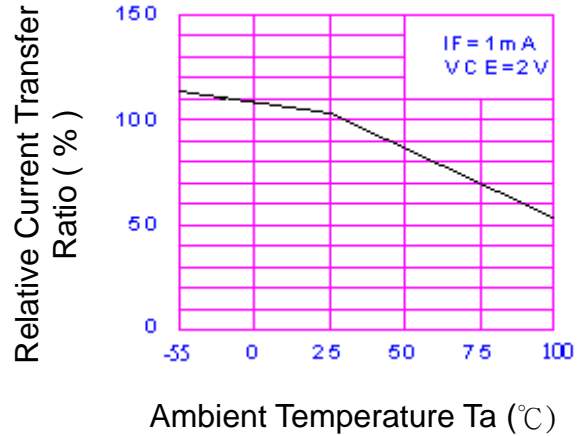

Fig.8 Collector-Emitter Saturation Voltage vs. Forward Current

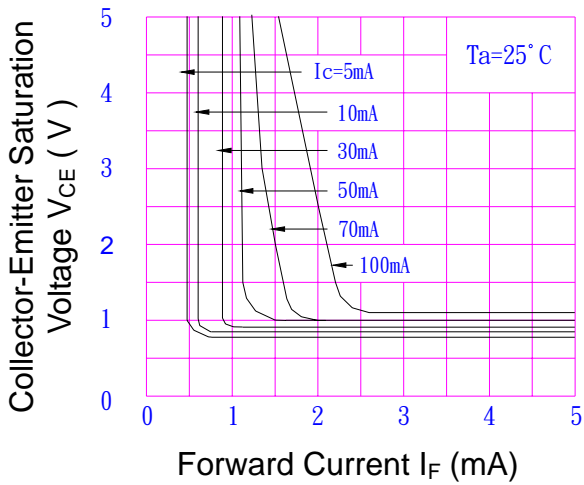
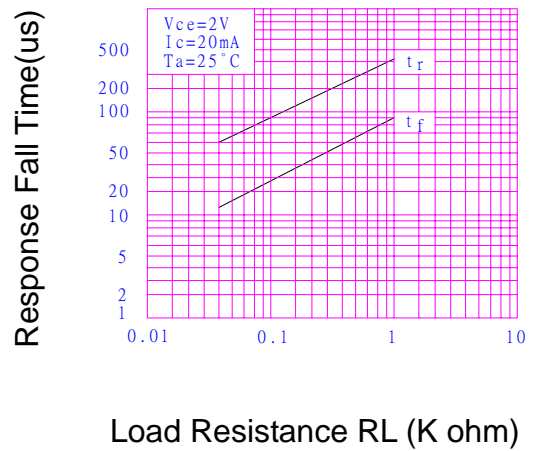

Fig.9 Response time vs. Load Resistance



PRODUCT SPECIFICATION

DATE : 01/20/2010

cosmo ELECTRONICS CORPORATION	Photocoupler : KP4010	NO.60P20017	REV.
		SHEET 6 OF 6	1

● Notice

The information contained in this document is intended to be a general product description and is subject to change without notice. Please contact cosmo in order to obtain the latest device data sheets before using any cosmo device. cosmo does not assume any responsibility for use of any circuitry described. No circuit patent licenses are implied. This publication is the property of cosmo. No part of this publication may be reproduced or copied in any form or by any means, or transferred to any third party without the prior written consent of cosmo Electronics Corporation.

The devices listed in this document are designed for general applications only in electronic equipment. No devices shall be deployed which require higher level of reliability such as :

- Medical and other life support equipments.
- Space application.
- Telecommunication equipment (trunk lines).
- Nuclear power control equipment.

Unless it received prior written approval from cosmo.

cosmo takes no responsibility for damages arise form the improper usage of our device. Please contact cosmo for further information regarding the above notices.