

LM117/LM317A/LM317

3-Terminal Adjustable Regulator

General Description

The LM117 series of adjustable 3-terminal positive voltage regulators is capable of supplying in excess of 1.5A over a 1.2V to 37V output range. They are exceptionally easy to use and require only two external resistors to set the output voltage. Further, both line and load regulation are better than standard fixed regulators. Also, the LM117 is packaged in standard transistor packages which are easily mounted and handled.

In addition to higher performance than fixed regulators, the LM117 series offers full overload protection available only in IC's. Included on the chip are current limit, thermal overload protection and safe area protection. All overload protection circuitry remains fully functional even if the adjustment terminal is disconnected.

Normally, no capacitors are needed unless the device is situated more than 6 inches from the input filter capacitors in which case an input bypass is needed. An optional output capacitor can be added to improve transient response. The adjustment terminal can be bypassed to achieve very high ripple rejection ratios which are difficult to achieve with standard 3-terminal regulators.

Besides replacing fixed regulators, the LM117 is useful in a wide variety of other applications. Since the regulator is "floating" and sees only the input-to-output differential volt-

age, supplies of several hundred volts can be regulated as long as the maximum input to output differential is not exceeded, i.e., avoid short-circuiting the output.

Also, it makes an especially simple adjustable switching regulator, a programmable output regulator, or by connecting a fixed resistor between the adjustment pin and output, the LM117 can be used as a precision current regulator. Supplies with electronic shutdown can be achieved by clamping the adjustment terminal to ground which programs the output to 1.2V where most loads draw little current.

For applications requiring greater output current, see LM150 series (3A) and LM138 series (5A) data sheets. For the negative complement, see LM137 series data sheet.

Features

- Guaranteed 1% output voltage tolerance (LM317A)
- Guaranteed max. 0.01%/V line regulation (LM317A)
- Guaranteed max. 0.3% load regulation (LM117)
- Guaranteed 1.5A output current
- Adjustable output down to 1.2V
- Current limit constant with temperature
- P+ Product Enhancement tested
- 80 dB ripple rejection
- Output is short-circuit protected

Typical Applications

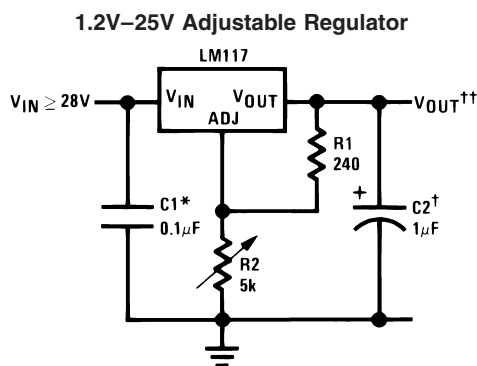

00906301

Full output current not available at high input-output voltages

*Needed if device is more than 6 inches from filter capacitors.

†Optional — improves transient response. Output capacitors in the range of 1μF to 1000μF of aluminum or tantalum electrolytic are commonly used to provide improved output impedance and rejection of transients.

$$\dagger\dagger V_{OUT} = 1.25V \left(1 + \frac{R_2}{R_1} \right) + I_{ADJ}(R_2)$$

LM117 Series Packages

Part Number Suffix	Package	Design Load Current
K	TO-3	1.5A
H	TO-39	0.5A
T	TO-220	1.5A
E	LCC	0.5A
S	TO-263	1.5A
EMP	SOT-223	1A
MDT	TO-252	0.5A

SOT-223 vs. D-Pak (TO-252) Packages

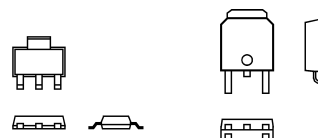

SOT-223

TO-252

00906354

Scale 1:1

Connection Diagrams

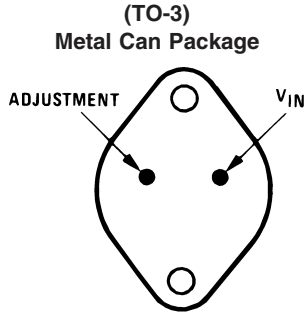

CASE IS OUTPUT

00906330

Bottom View
Steel Package
NS Package Number K02A or K02C

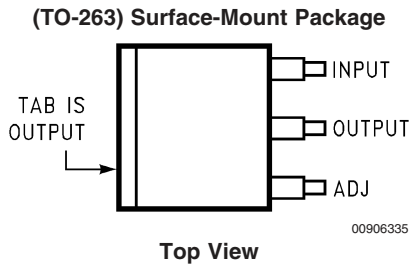

00906335

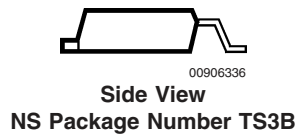

00906336

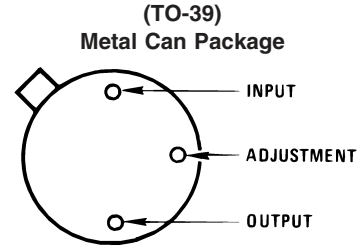

CASE IS OUTPUT

00906331

Bottom View
NS Package Number H03A

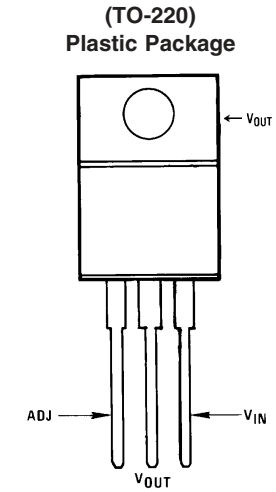

00906332

Front View
NS Package Number T03B

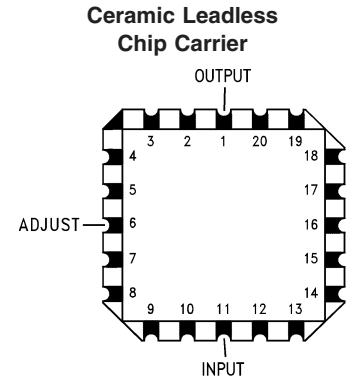

00906334

Top View
NS Package Number E20A

Connection Diagrams (Continued)

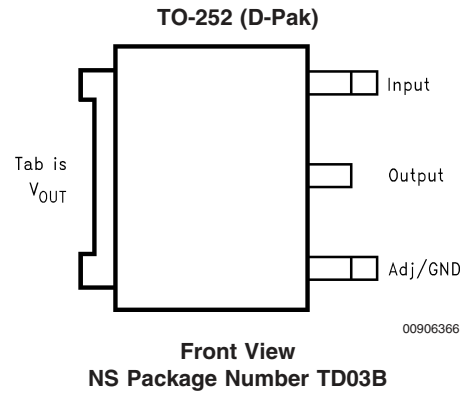
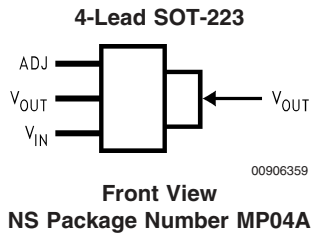

Ordering Information

Package	Temperature Range	Part Number	Package Marking	Transport Media	NSC Drawing
Metal Can (TO-3)	$-55^{\circ}\text{C} \leq T_J \leq +150^{\circ}\text{C}$	LM117K STEEL	LM117K STEEL P+	50 Per Bag	K02A
	$0^{\circ}\text{C} \leq T_J \leq +125^{\circ}\text{C}$	LM317K STEEL	LM317K STEEL P+	50 Per Bag	
	$-55^{\circ}\text{C} \leq T_J \leq +150^{\circ}\text{C}$	LM117K/883	LM117K/883	50 Per Bag	K02C
Metal Can (TO-39)	$-55^{\circ}\text{C} \leq T_J \leq +150^{\circ}\text{C}$	LM117H	LM117H P+	500 Per Box	H03A
	$-55^{\circ}\text{C} \leq T_J \leq +150^{\circ}\text{C}$	LM117H/883	LM117H/883	20 Per Tray	
	$-40^{\circ}\text{C} \leq T_J \leq +125^{\circ}\text{C}$	LM317AH	LM317AH P+	500 Per Box	
	$0^{\circ}\text{C} \leq T_J \leq +125^{\circ}\text{C}$	LM317H	LM317H P+	500 Per Box	
TO-220 3- Lead	$-40^{\circ}\text{C} \leq T_J \leq +125^{\circ}\text{C}$	LM317AT	LM317AT P+	45 Units/Rail	T03B
	$0^{\circ}\text{C} \leq T_J \leq +125^{\circ}\text{C}$	LM317T	LM317T P+	45 Units/Rail	
TO-263 3- Lead	$0^{\circ}\text{C} \leq T_J \leq +125^{\circ}\text{C}$	LM317S	LM317S P+	45 Units/Rail	TS3B
		LM317SX		500 Units Tape and Reel	
LCC	$-55^{\circ}\text{C} \leq T_J \leq +150^{\circ}\text{C}$	LM117E/883	LM117E/883	50 Units/Rail	E20A
SOT-223 4- Lead	$0^{\circ}\text{C} \leq T_J \leq +125^{\circ}\text{C}$	LM317EMP	N01A	1k Units Tape and Reel	MP04A
		LM317EMPX		2k Units Tape and Reel	
	$-40^{\circ}\text{C} \leq T_J \leq +125^{\circ}\text{C}$	LM317AEMP	N07A	1k Units Tape and Reel	
		LM317AEMPX		2k Units Tape and Reel	
D- Pack 3- Lead	$0^{\circ}\text{C} \leq T_J \leq +125^{\circ}\text{C}$	LM317MDT	LM317MDT	75 Units/Rail	TD03B
		LM317MDTX		2.5k Units Tape and Reel	
	$-40^{\circ}\text{C} \leq T_J \leq +125^{\circ}\text{C}$	LM317AMDT	LM317AMDT	75 Units/Rail	
		LM317AMDTX		2.5k Units Tape and Reel	

Absolute Maximum Ratings (Note 1)

If Military/Aerospace specified devices are required, please contact the National Semiconductor Sales Office/Distributors for availability and specifications.

Power Dissipation	Internally Limited
Input-Output Voltage Differential	+40V, -0.3V
Storage Temperature	-65°C to +150°C
Lead Temperature	
Metal Package (Soldering, 10 seconds)	300°C
Plastic Package (Soldering, 4 seconds)	260°C

ESD Tolerance (Note 5)

3 kV

Operating Temperature Range

LM117	-55°C ≤ T _J ≤ +150°C
LM317A	-40°C ≤ T _J ≤ +125°C
LM317	0°C ≤ T _J ≤ +125°C

Preconditioning

Thermal Limit Burn-In All Devices 100%

Electrical Characteristics (Note 3)

Specifications with standard type face are for T_J = 25°C, and those with **boldface type** apply over **full Operating Temperature Range**. Unless otherwise specified, V_{IN} - V_{OUT} = 5V, and I_{OUT} = 10 mA.

Parameter	Conditions	LM117 (Note 2)			Units	
		Min	Typ	Max		
Reference Voltage					V	
	3V ≤ (V _{IN} - V _{OUT}) ≤ 40V, 10 mA ≤ I _{OUT} ≤ I _{MAX} , P ≤ P _{MAX}	1.20	1.25	1.30	V	
Line Regulation	3V ≤ (V _{IN} - V _{OUT}) ≤ 40V (Note 4)		0.01	0.02	%/V	
			0.02	0.05	%/V	
Load Regulation	10 mA ≤ I _{OUT} ≤ I _{MAX} (Note 4)		0.1	0.3	%	
			0.3	1	%	
Thermal Regulation	20 ms Pulse		0.03	0.07	%/W	
Adjustment Pin Current			50	100	μA	
Adjustment Pin Current Change	10 mA ≤ I _{OUT} ≤ I _{MAX} 3V ≤ (V _{IN} - V _{OUT}) ≤ 40V		0.2	5	μA	
Temperature Stability	T _{MIN} ≤ T _J ≤ T _{MAX}		1		%	
Minimum Load Current	(V _{IN} - V _{OUT}) = 40V		3.5	5	mA	
Current Limit	(V _{IN} - V _{OUT}) ≤ 15V	K Package	1.5	2.2	3.4	A
		H Package	0.5	0.8	1.8	A
	(V _{IN} - V _{OUT}) = 40V	K Package	0.3	0.4		A
		H Package	0.15	0.2		A
RMS Output Noise, % of V _{OUT}	10 Hz ≤ f ≤ 10 kHz		0.003		%	
Ripple Rejection Ratio	V _{OUT} = 10V, f = 120 Hz, C _{ADJ} = 0 μF		65		dB	
	V _{OUT} = 10V, f = 120 Hz, C _{ADJ} = 10 μF	66	80		dB	
Long-Term Stability	T _J = 125°C, 1000 hrs		0.3	1	%	
Thermal Resistance, Junction-to-Case	K Package		2.3	3	°C/W	
	H Package		12	15	°C/W	
	E Package				°C/W	
Thermal Resistance, Junction- to-Ambient (No Heat Sink)	K Package		35		°C/W	
	H Package		140		°C/W	
	E Package				°C/W	

Electrical Characteristics (Note 3)

Specifications with standard type face are for $T_J = 25^\circ\text{C}$, and those with **boldface type** apply over **full Operating Temperature Range**. Unless otherwise specified, $V_{IN} - V_{OUT} = 5\text{V}$, and $I_{OUT} = 10\text{mA}$.

Parameter	Conditions	LM317A			LM317			Units	
		Min	Typ	Max	Min	Typ	Max		
Reference Voltage		1.238	1.250	1.262				V	
	$3\text{V} \leq (V_{IN} - V_{OUT}) \leq 40\text{V}$, $10\text{mA} \leq I_{OUT} \leq I_{MAX}$, $P \leq P_{MAX}$	1.225	1.250	1.270	1.20	1.25	1.30	V	
Line Regulation	$3\text{V} \leq (V_{IN} - V_{OUT}) \leq 40\text{V}$ (Note 4)		0.005	0.01		0.01	0.04	%/V	
			0.01	0.02		0.02	0.07	%/V	
Load Regulation	$10\text{mA} \leq I_{OUT} \leq I_{MAX}$ (Note 4)		0.1	0.5		0.1	0.5	%	
			0.3	1		0.3	1.5	%	
Thermal Regulation	20 ms Pulse		0.04	0.07		0.04	0.07	%/W	
Adjustment Pin Current			50	100		50	100	μA	
Adjustment Pin Current Change	$10\text{mA} \leq I_{OUT} \leq I_{MAX}$ $3\text{V} \leq (V_{IN} - V_{OUT}) \leq 40\text{V}$		0.2	5		0.2	5	μA	
Temperature Stability	$T_{MIN} \leq T_J \leq T_{MAX}$		1			1		%	
Minimum Load Current	$(V_{IN} - V_{OUT}) = 40\text{V}$		3.5	10		3.5	10	mA	
Current Limit	$(V_{IN} - V_{OUT}) \leq 15\text{V}$ K, T, S Packages H Package MP Package		1.5	2.2	3.4	1.5	2.2	3.4	A
			0.5	0.8	1.8	0.5	0.8	1.8	A
			1.5	2.2	3.4	1.5	2.2	3.4	A
	$(V_{IN} - V_{OUT}) = 40\text{V}$ K, T, S Packages H Package MP Package		0.15	0.4		0.15	0.4		A
			0.075	0.2		0.075	0.2		A
			0.15	0.4		0.15	0.4		A
RMS Output Noise, % of V_{OUT}	$10\text{Hz} \leq f \leq 10\text{kHz}$		0.003			0.003		%	
Ripple Rejection Ratio	$V_{OUT} = 10\text{V}$, $f = 120\text{Hz}$, $C_{ADJ} = 0\mu\text{F}$		65			65		dB	
	$V_{OUT} = 10\text{V}$, $f = 120\text{Hz}$, $C_{ADJ} = 10\mu\text{F}$		66	80		66	80	dB	
Long-Term Stability	$T_J = 125^\circ\text{C}$, 1000 hrs		0.3	1		0.3	1	%	
Thermal Resistance, Junction-to-Case	K Package					2.3	3	$^\circ\text{C/W}$	
	MDT Package					5		$^\circ\text{C/W}$	
	H Package		12	15		12	15	$^\circ\text{C/W}$	
	T Package		4	5		4		$^\circ\text{C/W}$	
	MP Package		23.5			23.5		$^\circ\text{C/W}$	
Thermal Resistance, Junction-to-Ambient (No Heat Sink)	K Package		35			35		$^\circ\text{C/W}$	
	MDT Package (Note 6)					92		$^\circ\text{C/W}$	
	H Package		140			140		$^\circ\text{C/W}$	
	T Package		50			50		$^\circ\text{C/W}$	
	S Package (Note 6)		50			50		$^\circ\text{C/W}$	

Note 1: Absolute Maximum Ratings indicate limits beyond which damage to the device may occur. Operating Ratings indicate conditions for which the device is intended to be functional, but do not guarantee specific performance limits. For guaranteed specifications and test conditions, see the Electrical Characteristics. The guaranteed specifications apply only for the test conditions listed.

Note 2: Refer to RETS117H drawing for the LM117H, or the RETS117K for the LM117K military specifications.

Note 3: Although power dissipation is internally limited, these specifications are applicable for maximum power dissipations of 2W for the TO-39 and SOT-223 and 20W for the TO-3, TO-220, and TO-263. I_{MAX} is 1.5A for the TO-3, TO-220, and TO-263 packages, 0.5A for the TO-39 package and 1A for the SOT-223 Package. All limits (i.e., the numbers in the Min. and Max. columns) are guaranteed to National's AOQL (Average Outgoing Quality Level).

Note 4: Regulation is measured at a constant junction temperature, using pulse testing with a low duty cycle. Changes in output voltage due to heating effects are covered under the specifications for thermal regulation.

Note 5: Human body model, 100 pF discharged through a 1.5 k Ω resistor.

Note 6: If the TO-263 or TO-252 packages are used, the thermal resistance can be reduced by increasing the PC board copper area thermally connected to the package. Using 0.5 square inches of copper area, θ_{JA} is 50°C/W ; with 1 square inch of copper area, θ_{JA} is 37°C/W ; and with 1.6 or more square inches of copper area, θ_{JA} is 32°C/W . If the SOT-223 package is used, the thermal resistance can be reduced by increasing the PC board copper area (see applications hints for heatsinking).

Typical Performance Characteristics Output Capacitor = 0 μ F unless otherwise noted

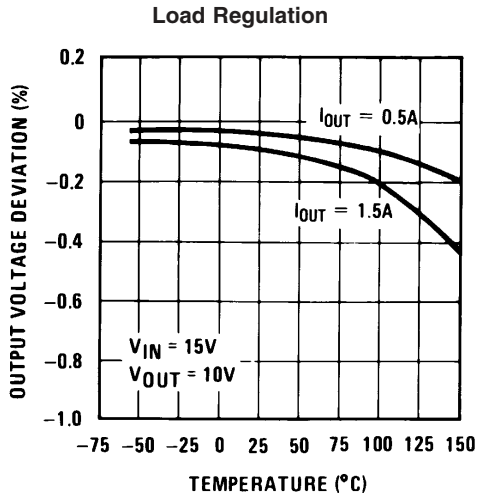

00906337

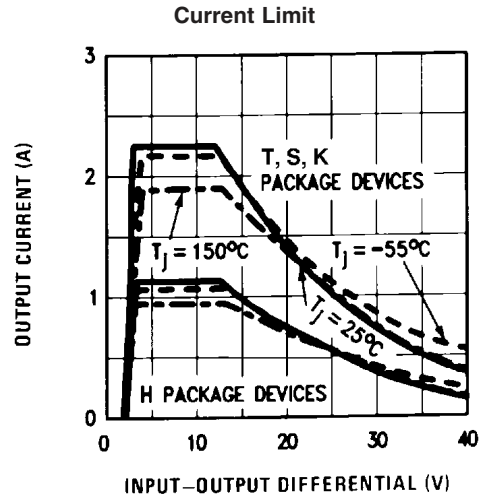

00906338

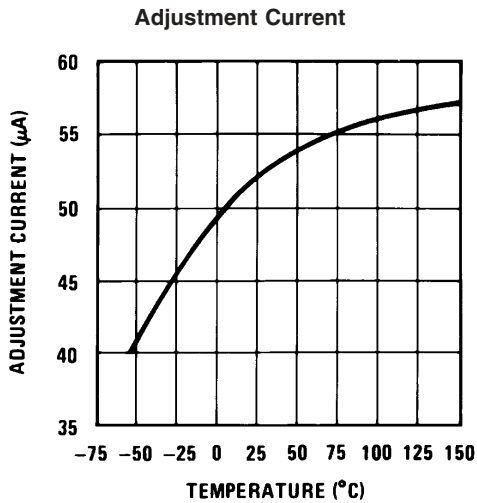

00906339

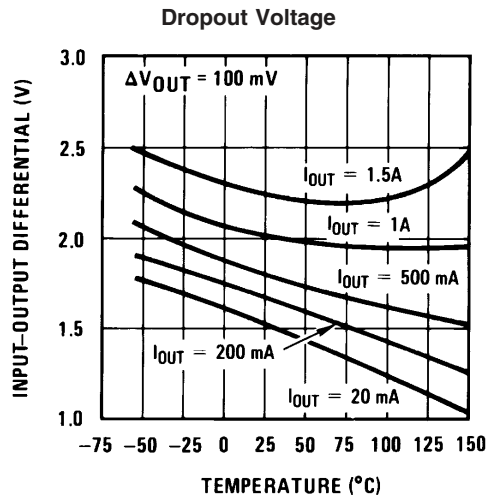

00906340

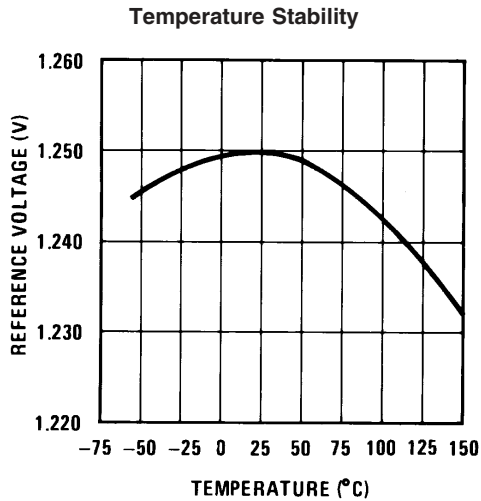

00906341

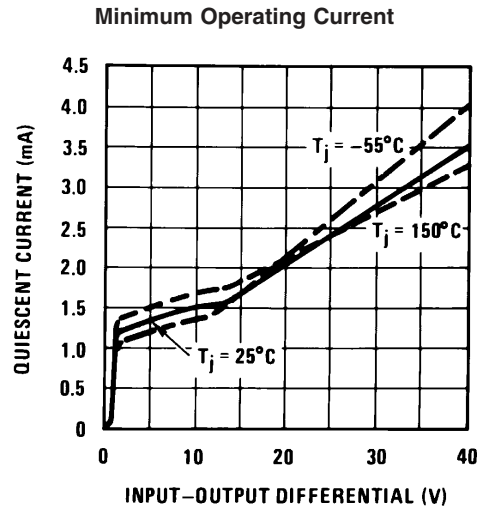

00906342

Typical Performance Characteristics Output Capacitor = 0 μ F unless otherwise noted (Continued)

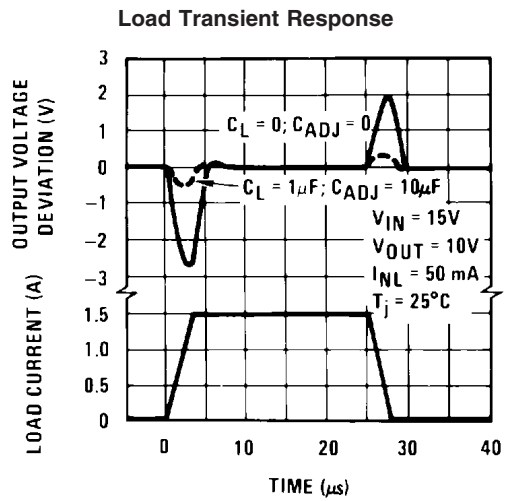
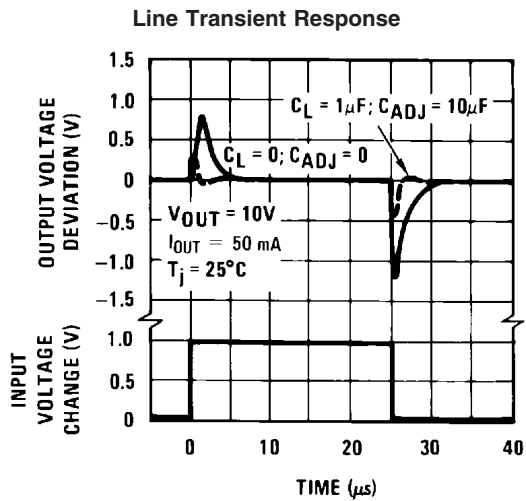
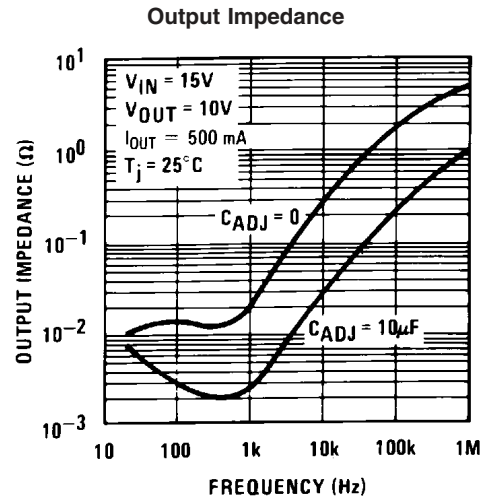
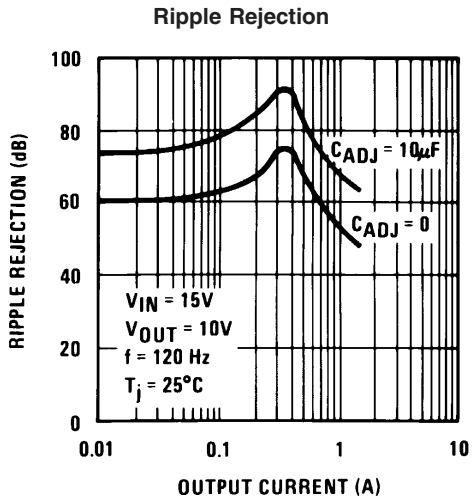
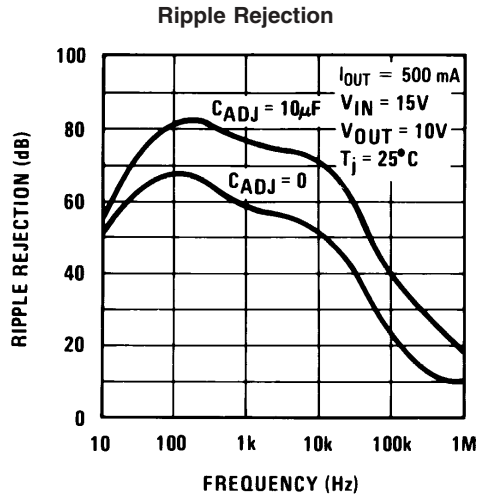
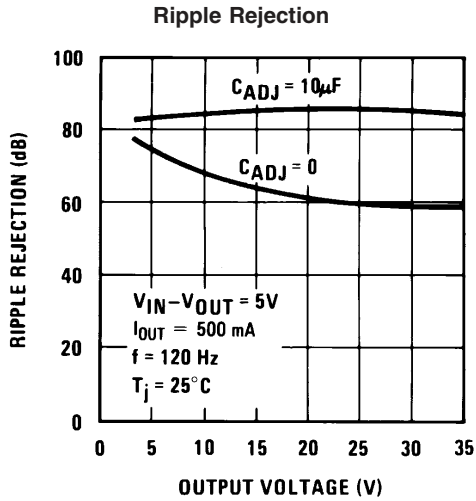

Application Hints

In operation, the LM117 develops a nominal 1.25V reference voltage, V_{REF} , between the output and adjustment terminal. The reference voltage is impressed across program resistor R1 and, since the voltage is constant, a constant current I_1 then flows through the output set resistor R2, giving an output voltage of

$$V_{OUT} = V_{REF} \left(1 + \frac{R_2}{R_1} \right) + I_{ADJ} R_2$$

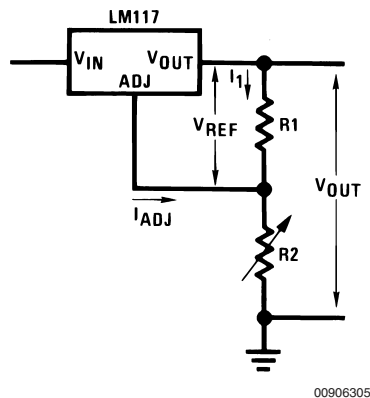

FIGURE 1.

Since the 100 μ A current from the adjustment terminal represents an error term, the LM117 was designed to minimize I_{ADJ} and make it very constant with line and load changes. To do this, all quiescent operating current is returned to the output establishing a minimum load current requirement. If there is insufficient load on the output, the output will rise.

EXTERNAL CAPACITORS

An input bypass capacitor is recommended. A 0.1 μ F disc or 1 μ F solid tantalum on the input is suitable input bypassing for almost all applications. The device is more sensitive to the absence of input bypassing when adjustment or output capacitors are used but the above values will eliminate the possibility of problems.

The adjustment terminal can be bypassed to ground on the LM117 to improve ripple rejection. This bypass capacitor prevents ripple from being amplified as the output voltage is increased. With a 10 μ F bypass capacitor 80dB ripple rejection is obtainable at any output level. Increases over 10 μ F do not appreciably improve the ripple rejection at frequencies above 120Hz. If the bypass capacitor is used, it is sometimes necessary to include protection diodes to prevent the capacitor from discharging through internal low current paths and damaging the device.

In general, the best type of capacitors to use is solid tantalum. Solid tantalum capacitors have low impedance even at high frequencies. Depending upon capacitor construction, it takes about 25 μ F in aluminum electrolytic to equal 1 μ F solid tantalum at high frequencies. Ceramic capacitors are also good at high frequencies; but some types have a large decrease in capacitance at frequencies around 0.5MHz. For this reason, 0.01 μ F disc may seem to work better than a 0.1 μ F disc as a bypass.

Although the LM117 is stable with no output capacitors, like any feedback circuit, certain values of external capacitance

can cause excessive ringing. This occurs with values between 500 pF and 5000 pF. A 1 μ F solid tantalum (or 25 μ F aluminum electrolytic) on the output swamps this effect and insures stability. Any increase of the load capacitance larger than 10 μ F will merely improve the loop stability and output impedance.

LOAD REGULATION

The LM117 is capable of providing extremely good load regulation but a few precautions are needed to obtain maximum performance. The current set resistor connected between the adjustment terminal and the output terminal (usually 240 Ω) should be tied directly to the output (case) of the regulator rather than near the load. This eliminates line drops from appearing effectively in series with the reference and degrading regulation. For example, a 15V regulator with 0.05 Ω resistance between the regulator and load will have a load regulation due to line resistance of 0.05 Ω \times I_L . If the set resistor is connected near the load the effective line resistance will be 0.05 Ω (1 + R_2/R_1) or in this case, 11.5 times worse.

Figure 2 shows the effect of resistance between the regulator and 240 Ω set resistor.

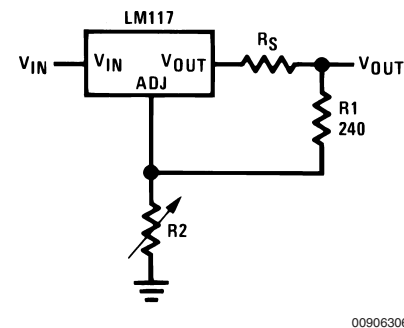

FIGURE 2. Regulator with Line Resistance in Output Lead

With the TO-3 package, it is easy to minimize the resistance from the case to the set resistor, by using two separate leads to the case. However, with the TO-39 package, care should be taken to minimize the wire length of the output lead. The ground of R_2 can be returned near the ground of the load to provide remote ground sensing and improve load regulation.

PROTECTION DIODES

When external capacitors are used with any IC regulator it is sometimes necessary to add protection diodes to prevent the capacitors from discharging through low current points into the regulator. Most 10 μ F capacitors have low enough internal series resistance to deliver 20A spikes when shorted. Although the surge is short, there is enough energy to damage parts of the IC.

When an output capacitor is connected to a regulator and the input is shorted, the output capacitor will discharge into the output of the regulator. The discharge current depends on the value of the capacitor, the output voltage of the regulator, and the rate of decrease of V_{IN} . In the LM117, this discharge path is through a large junction that is able to sustain 15A surge with no problem. This is not true of other types of positive regulators. For output capacitors of 25 μ F or less, there is no need to use diodes.

The bypass capacitor on the adjustment terminal can discharge through a low current junction. Discharge occurs

Application Hints (Continued)

when *either* the input or output is shorted. Internal to the LM117 is a 50Ω resistor which limits the peak discharge current. No protection is needed for output voltages of 25V or less and 10μF capacitance. *Figure 3* shows an LM117 with protection diodes included for use with outputs greater than 25V and high values of output capacitance.

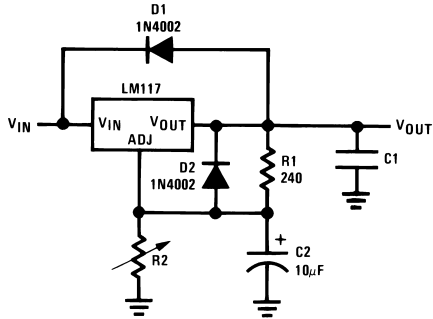

00906307

$$V_{OUT} = 1.25V \left(1 + \frac{R_2}{R_1} \right) + I_{ADJ}R_2$$

D1 protects against C1
D2 protects against C2

FIGURE 3. Regulator with Protection Diodes

When a value for $\theta_{(H-A)}$ is found using the equation shown, a heatsink must be selected that has a value that is less than or equal to this number.

$\theta_{(H-A)}$ is specified numerically by the heatsink manufacturer in the catalog, or shown in a curve that plots temperature rise vs power dissipation for the heatsink.

HEATSINKING TO-263, SOT-223 AND TO-252 PACKAGE PARTS

The TO-263 ("S"), SOT-223 ("MP") and TO-252 ("DT") packages use a copper plane on the PCB and the PCB itself as a heatsink. To optimize the heat sinking ability of the plane and PCB, solder the tab of the package to the plane.

Figure 4 shows for the TO-263 the measured values of $\theta_{(J-A)}$ for different copper area sizes using a typical PCB with 1 ounce copper and no solder mask over the copper area used for heatsinking.

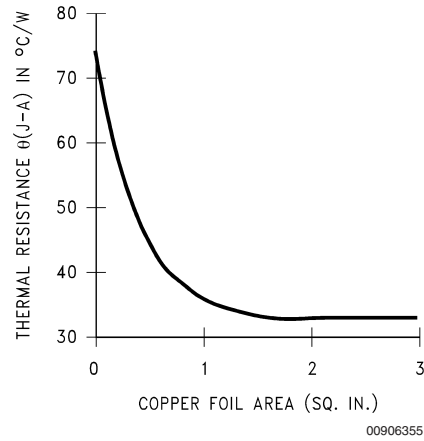

00906355

FIGURE 4. $\theta_{(J-A)}$ vs Copper (1 ounce) Area for the TO-263 Package

As shown in the figure, increasing the copper area beyond 1 square inch produces very little improvement. It should also be observed that the minimum value of $\theta_{(J-A)}$ for the TO-263 package mounted to a PCB is 32°C/W.

As a design aid, *Figure 5* shows the maximum allowable power dissipation compared to ambient temperature for the TO-263 device (assuming $\theta_{(J-A)}$ is 35°C/W and the maximum junction temperature is 125°C).

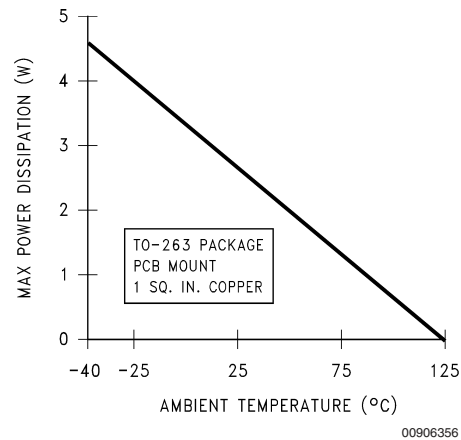

00906356

FIGURE 5. Maximum Power Dissipation vs T_{AMB} for the TO-263 Package

Figure 6 and *Figure 7* show the information for the SOT-223 package. *Figure 7* assumes a $\theta_{(J-A)}$ of 74°C/W for 1 ounce copper and 51°C/W for 2 ounce copper and a maximum junction temperature of 125°C.

Application Hints (Continued)

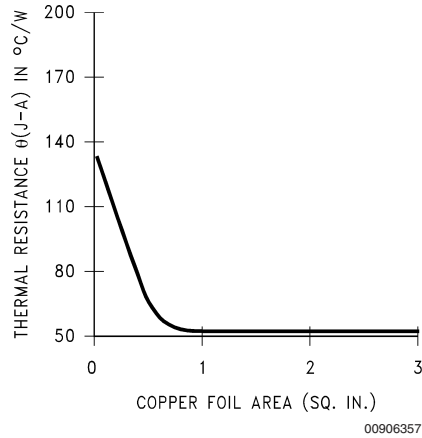

FIGURE 6. $\theta_{(J-A)}$ vs Copper (2 ounce) Area for the SOT-223 Package

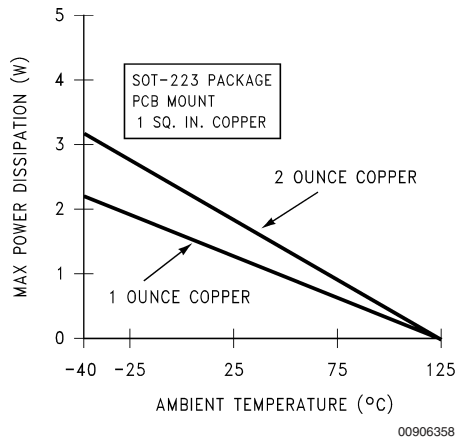

FIGURE 7. Maximum Power Dissipation vs T_{AMB} for the SOT-223 Package

The LM317 regulators have internal thermal shutdown to protect the device from over-heating. Under all possible operating conditions, the junction temperature of the LM317 must be within the range of 0°C to 125°C. A heatsink may be required depending on the maximum power dissipation and maximum ambient temperature of the application. To deter-

mine if a heatsink is needed, the power dissipated by the regulator, P_D , must be calculated:

$$I_{IN} = I_L + I_G$$

$$P_D = (V_{IN} - V_{OUT}) I_L + V_{IN} I_G$$

Figure 8 shows the voltage and currents which are present in the circuit.

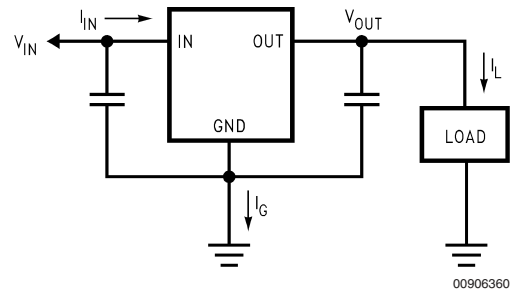

FIGURE 8. Power Dissipation Diagram

The next parameter which must be calculated is the maximum allowable temperature rise, $T_R(max)$:

$$T_R(max) = T_J(max) - T_A(max)$$

where $T_J(max)$ is the maximum allowable junction temperature (125°C), and $T_A(max)$ is the maximum ambient temperature which will be encountered in the application.

Using the calculated values for $T_R(max)$ and P_D , the maximum allowable value for the junction-to-ambient thermal resistance (θ_{JA}) can be calculated:

$$\theta_{JA} = T_R(max)/P_D$$

If the maximum allowable value for θ_{JA} is found to be $\geq 92^\circ\text{C/W}$ (Typical Rated Value) for TO-252 package, no heatsink is needed since the package alone will dissipate enough heat to satisfy these requirements. If the calculated value for θ_{JA} falls below these limits, a heatsink is required.

As a design aid, Table 1 shows the value of the θ_{JA} of TO-252 for different heatsink area. The copper patterns that we used to measure these θ_{JA} s are shown at the end of the Application Notes Section. Figure 9 reflects the same test results as what are in the Table 1

Figure 10 shows the maximum allowable power dissipation vs. ambient temperature for the TO-252 device. Figure 11 shows the maximum allowable power dissipation vs. copper area (in²) for the TO-252 device. Please see AN1028 for power enhancement techniques to be used with SOT-223 and TO-252 packages.

TABLE 1. θ_{JA} Different Heatsink Area

Layout	Copper Area		Thermal Resistance (θ_{JA} °C/W) TO-252
	Top Side (in ²)*	Bottom Side (in ²)	
1	0.0123	0	103
2	0.066	0	87
3	0.3	0	60
4	0.53	0	54
5	0.76	0	52
6	1	0	47
7	0	0.2	84
8	0	0.4	70
9	0	0.6	63

Application Hints (Continued)

TABLE 1. θ_{JA} Different Heatsink Area (Continued)

Layout	Copper Area		Thermal Resistance
10	0	0.8	57
11	0	1	57
12	0.066	0.066	89
13	0.175	0.175	72
14	0.284	0.284	61
15	0.392	0.392	55
16	0.5	0.5	53

Note: * Tab of device attached to topside of copper.

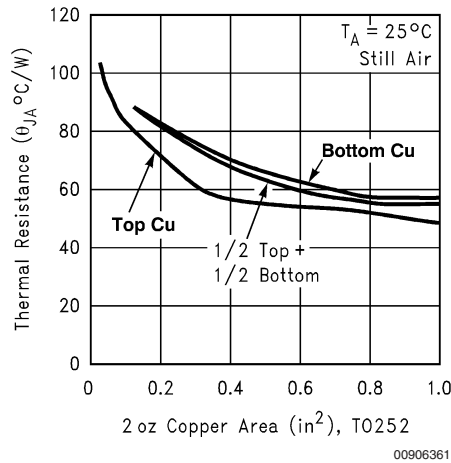

FIGURE 9. θ_{JA} vs 2oz Copper Area for TO-252

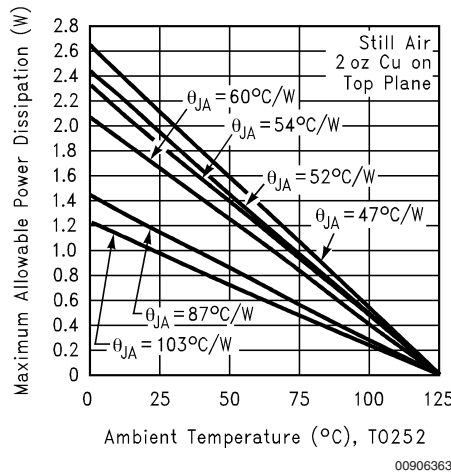

FIGURE 10. Maximum Allowable Power Dissipation vs. Ambient Temperature for TO-252

Application Hints (Continued)

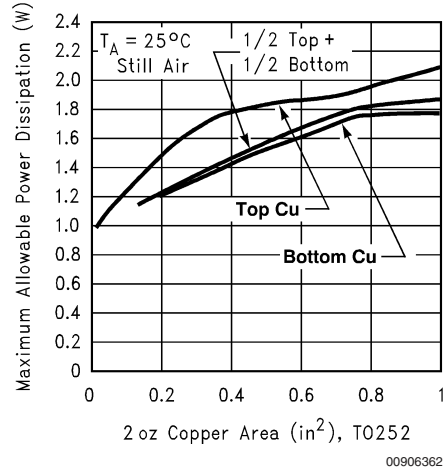

FIGURE 11. Maximum Allowable Power Dissipation vs. 2oz Copper Area for TO-252

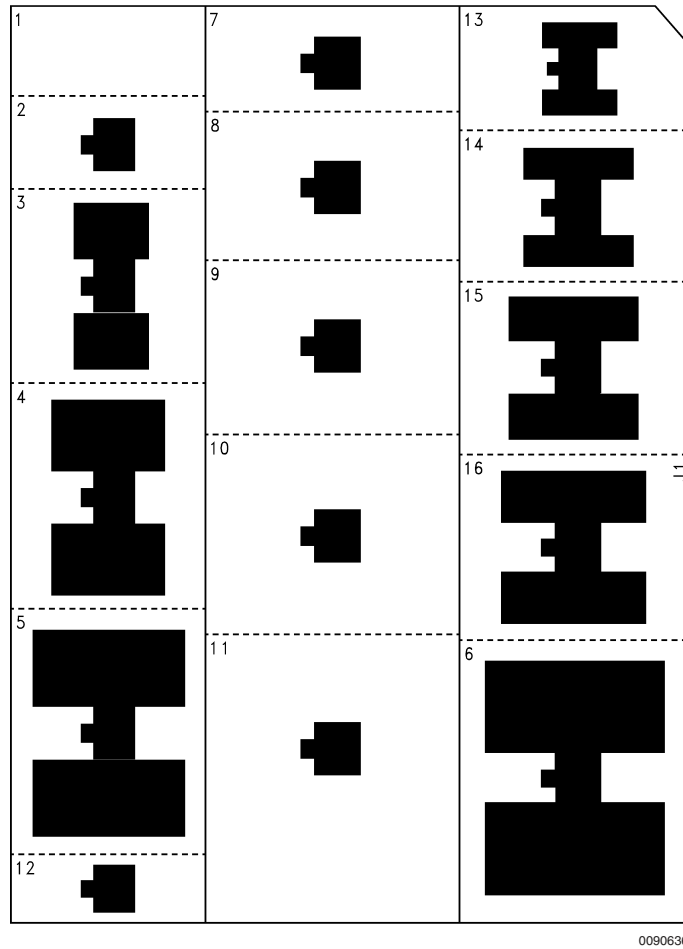

FIGURE 12. Top View of the Thermal Test Pattern in Actual Scale

Application Hints (Continued)

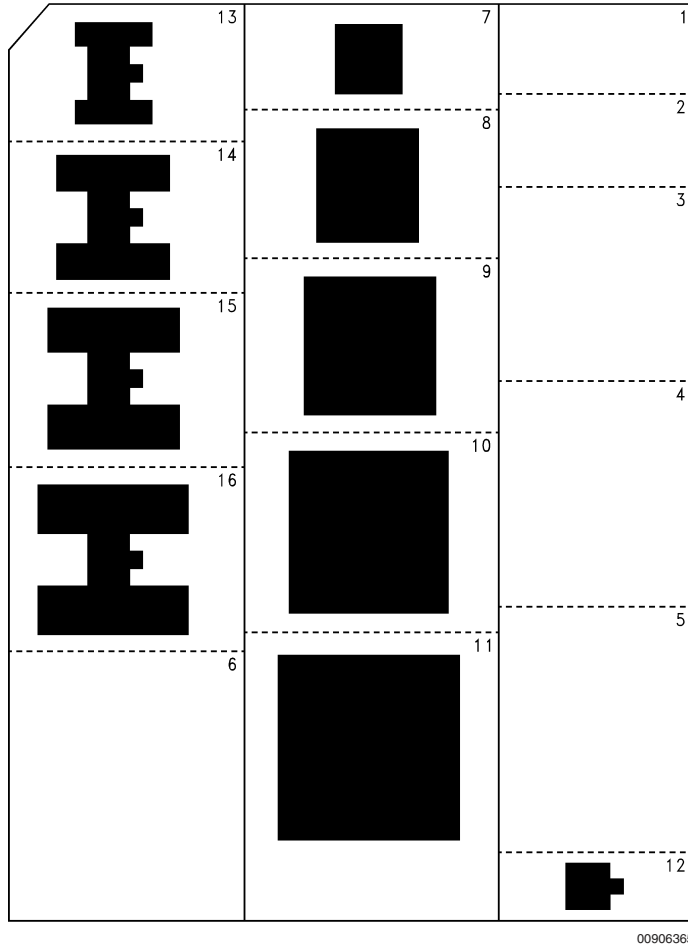
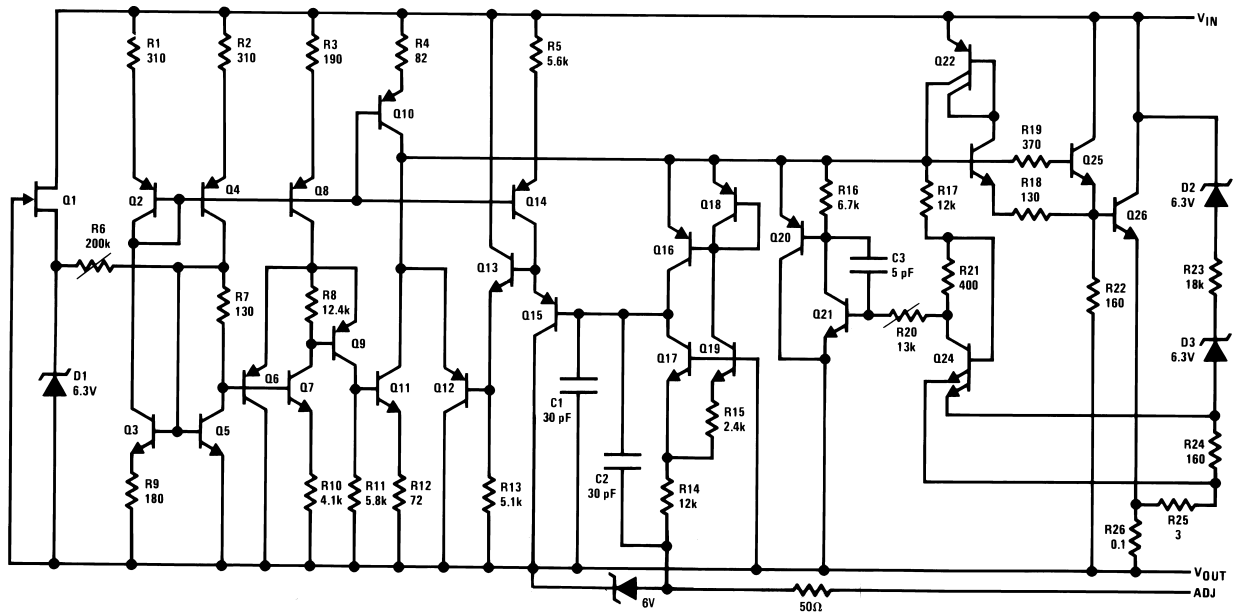

FIGURE 13. Bottom View of the Thermal Test Pattern in Actual Scale

Schematic Diagram



00906308

Typical Applications

5V Logic Regulator with Electronic Shutdown*

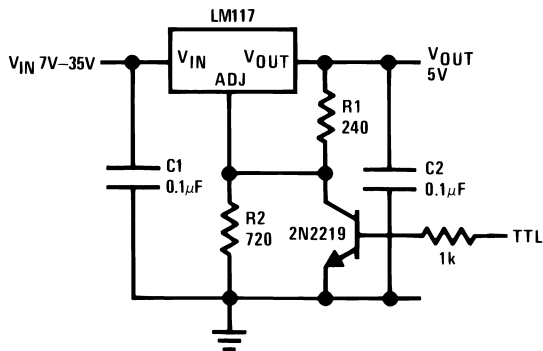

00906303

*Min. output = 1.2V

Adjustable Regulator with Improved Ripple Rejection

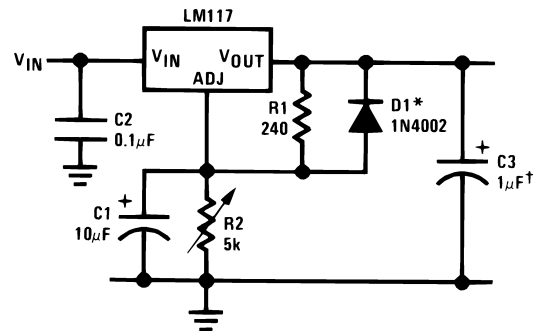

00906310

†Solid tantalum

*Discharges C1 if output is shorted to ground

Slow Turn-On 15V Regulator

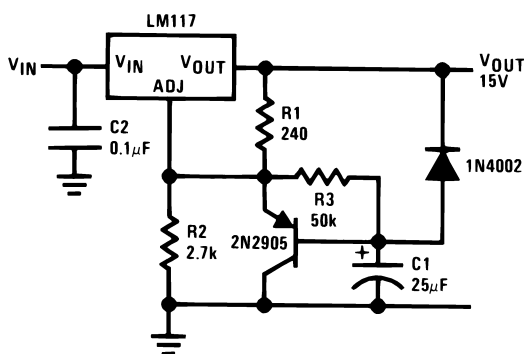

00906309

High Stability 10V Regulator

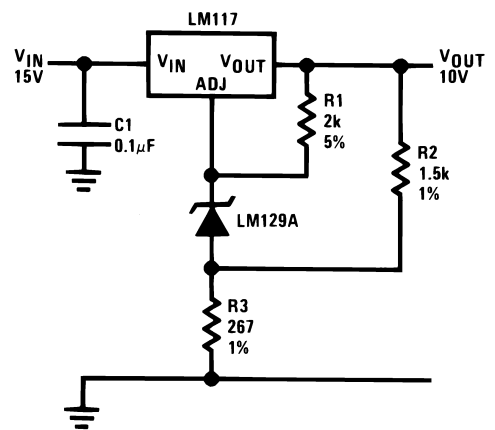

00906311

Typical Applications (Continued)

High Current Adjustable Regulator

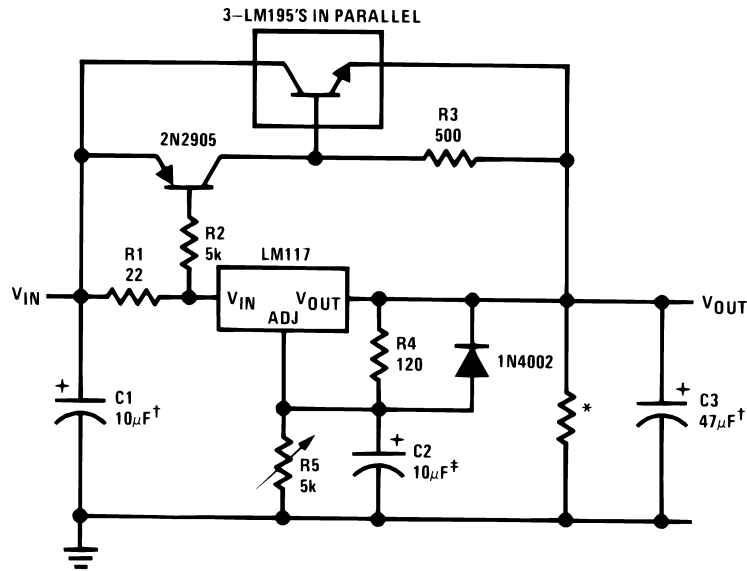

00906312

‡Optional — improves ripple rejection

†Solid tantalum

*Minimum load current = 30 mA

0 to 30V Regulator

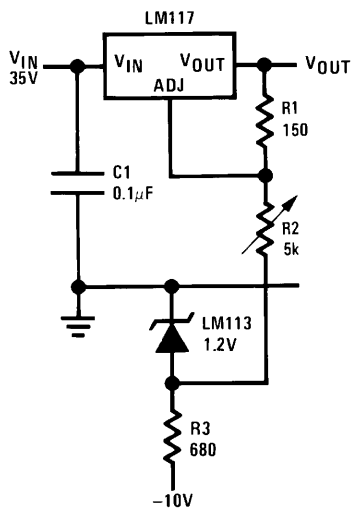

00906313

Full output current not available at high input-output voltages

Power Follower

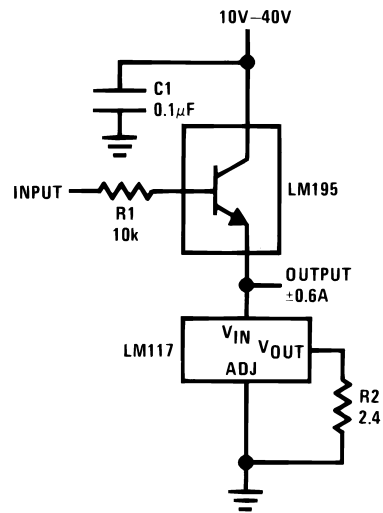

00906314

Typical Applications (Continued)

5A Constant Voltage/Constant Current Regulator

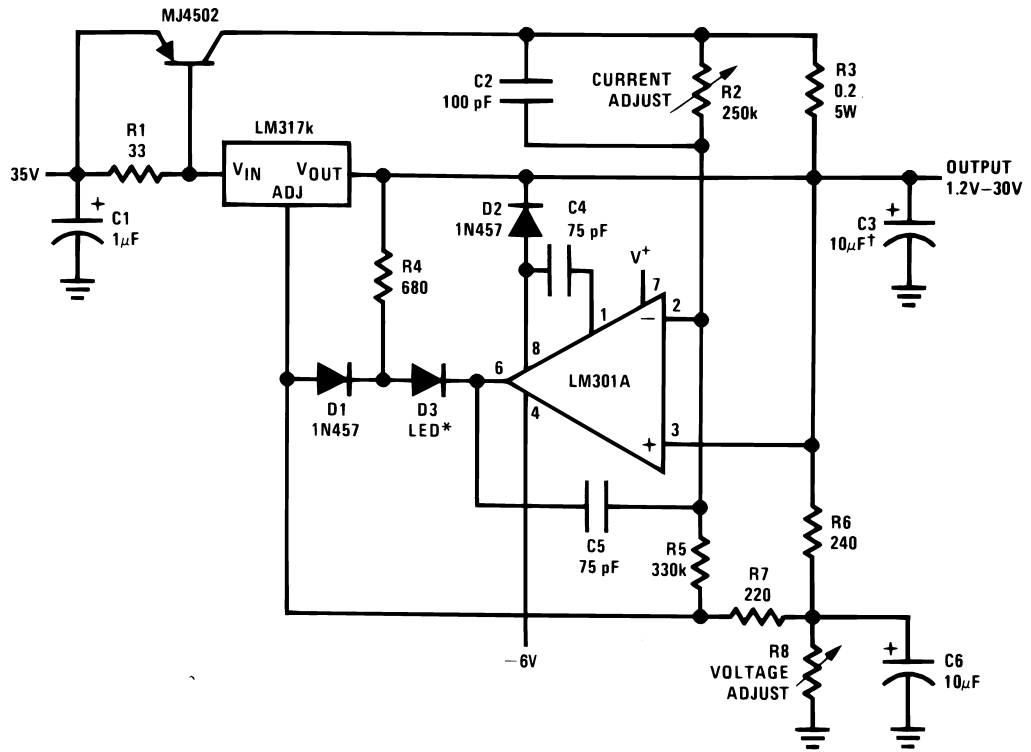

†Solid tantalum

*Lights in constant current mode

00906315

1A Current Regulator

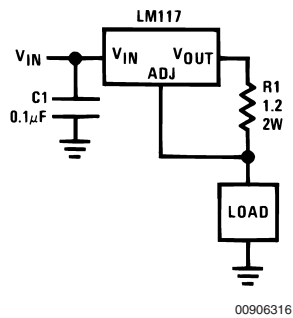

00906316

High Gain Amplifier

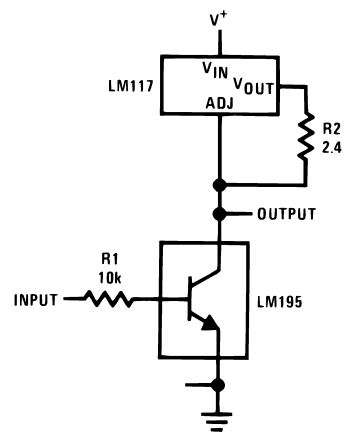

00906318

1.2V-20V Regulator with Minimum Program Current

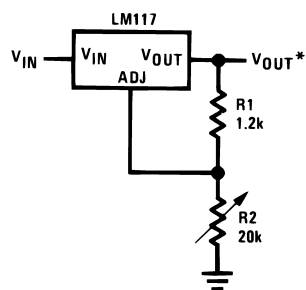

00906317

*Minimum load current \approx 4 mA

Typical Applications (Continued)

Low Cost 3A Switching Regulator

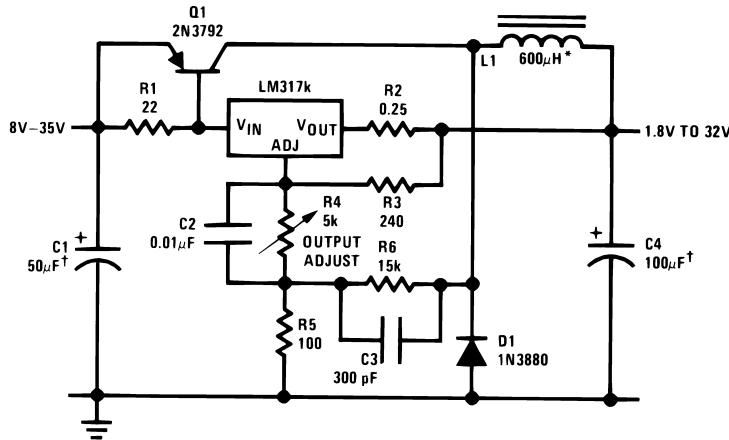

00906319

†Solid tantalum

*Core—Arnold A-254168-2 60 turns

4A Switching Regulator with Overload Protection

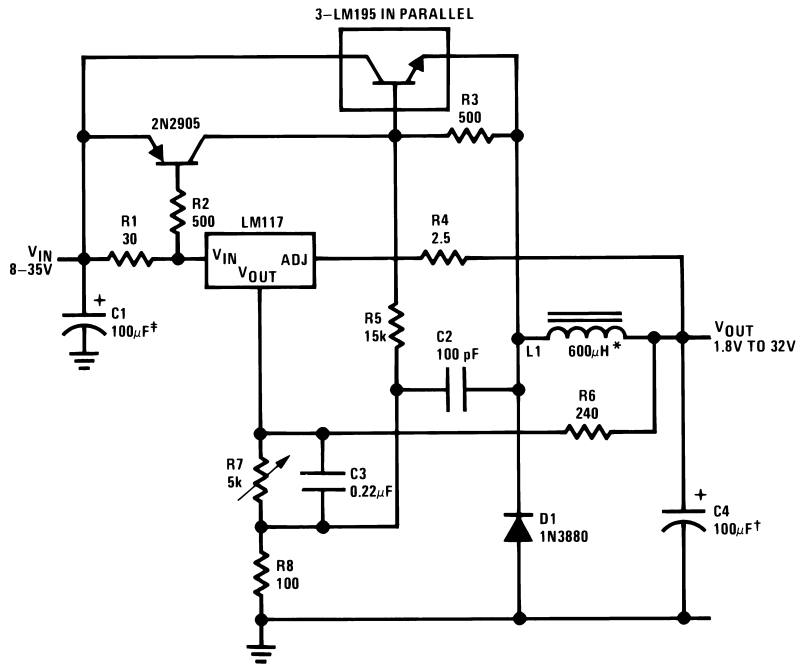

00906320

†Solid tantalum

*Core—Arnold A-254168-2 60 turns

Precision Current Limiter

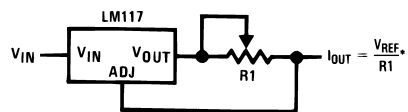

$$*0.8\Omega \leq R1 \leq 120\Omega$$

00906321

Typical Applications (Continued)

Tracking Preregulator

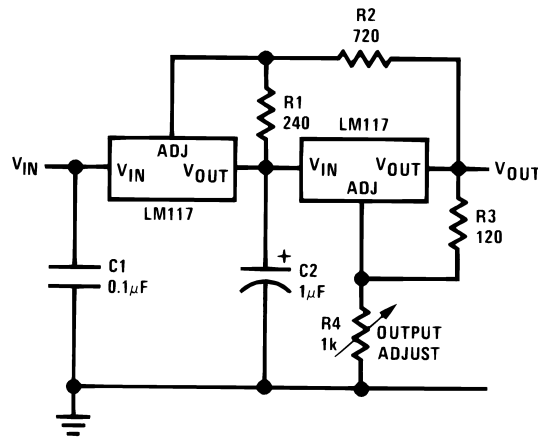

00906322

Current Limited Voltage Regulator

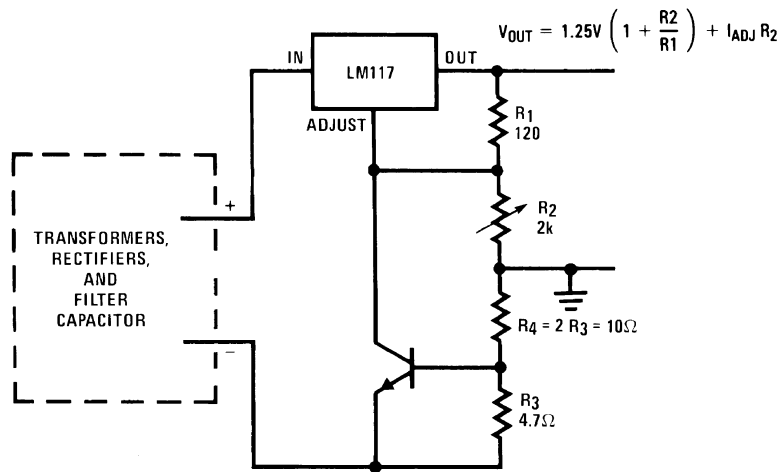

00906323

— Short circuit current is approximately $\frac{600 \text{ mV}}{R_3}$, or 120 mA

(Compared to LM117's higher current limit)

— At 50 mA output only 3/4 volt of drop occurs in R₃ and R₄

Adjusting Multiple On-Card Regulators with Single Control*

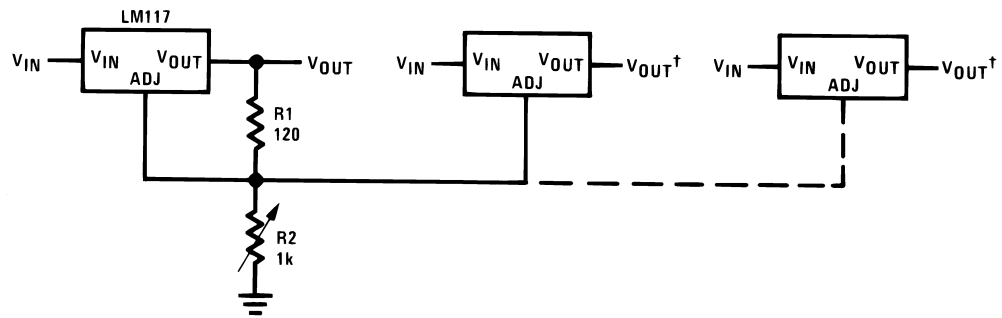

*All outputs within ±100 mV

†Minimum load — 10 mA

00906324

Typical Applications (Continued)

AC Voltage Regulator

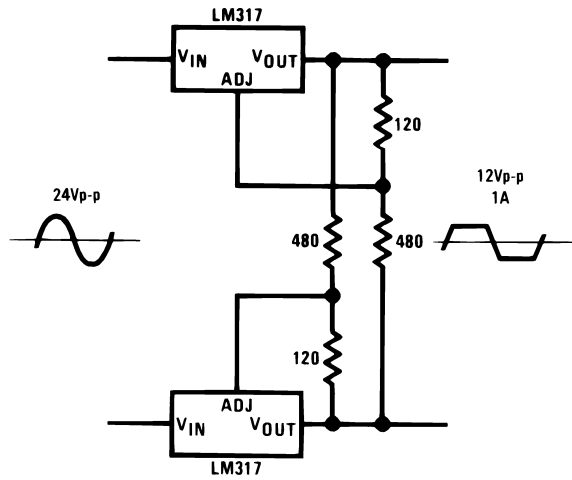

00906325

12V Battery Charger

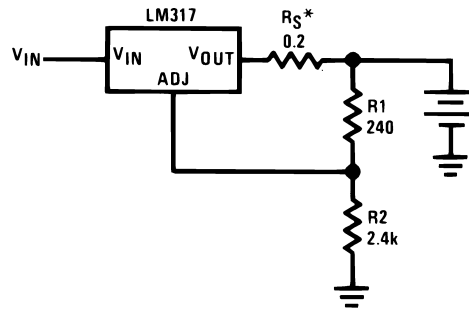

00906326

* R_S —sets output impedance of charger: $Z_{OUT} = R_S \left(1 + \frac{R_2}{R_1} \right)$

Use of R_S allows low charging rates with fully charged battery.

50mA Constant Current Battery Charger

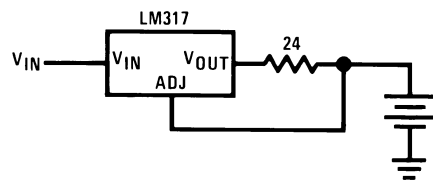

00906327

Typical Applications (Continued)

Adjustable 4A Regulator

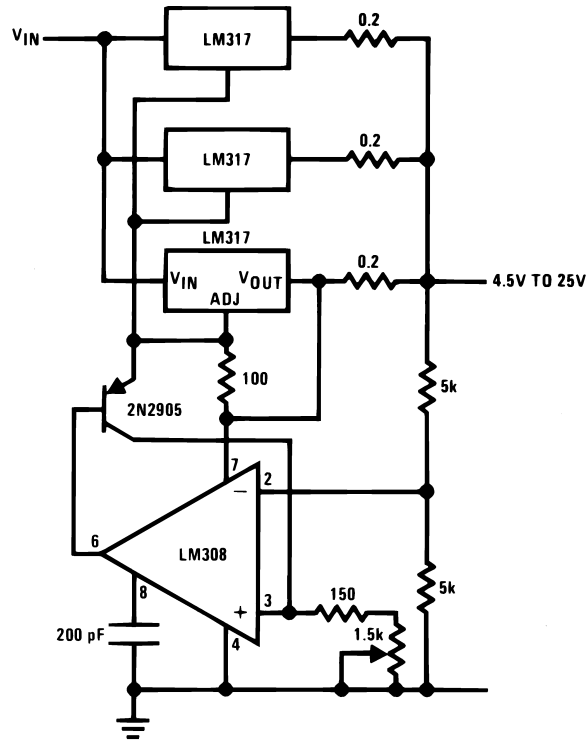

00906328

Current Limited 6V Charger

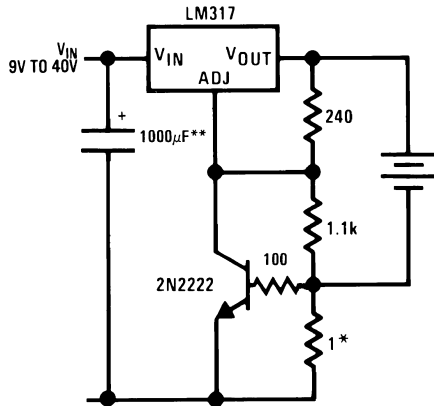

00906329

*Sets peak current (0.6A for 1Ω)

**The 1000µF is recommended to filter out input transients

Digitally Selected Outputs

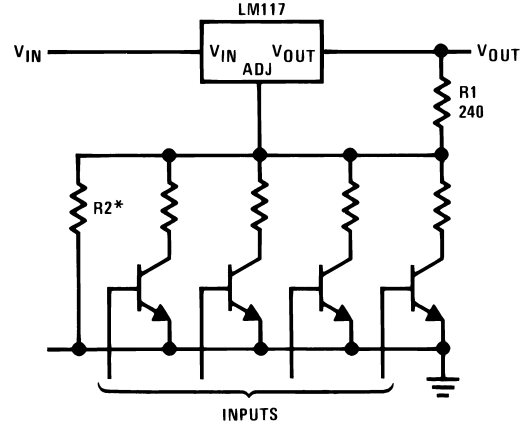

00906302

*Sets maximum V_{OUT}

Physical Dimensions inches (millimeters)

unless otherwise noted

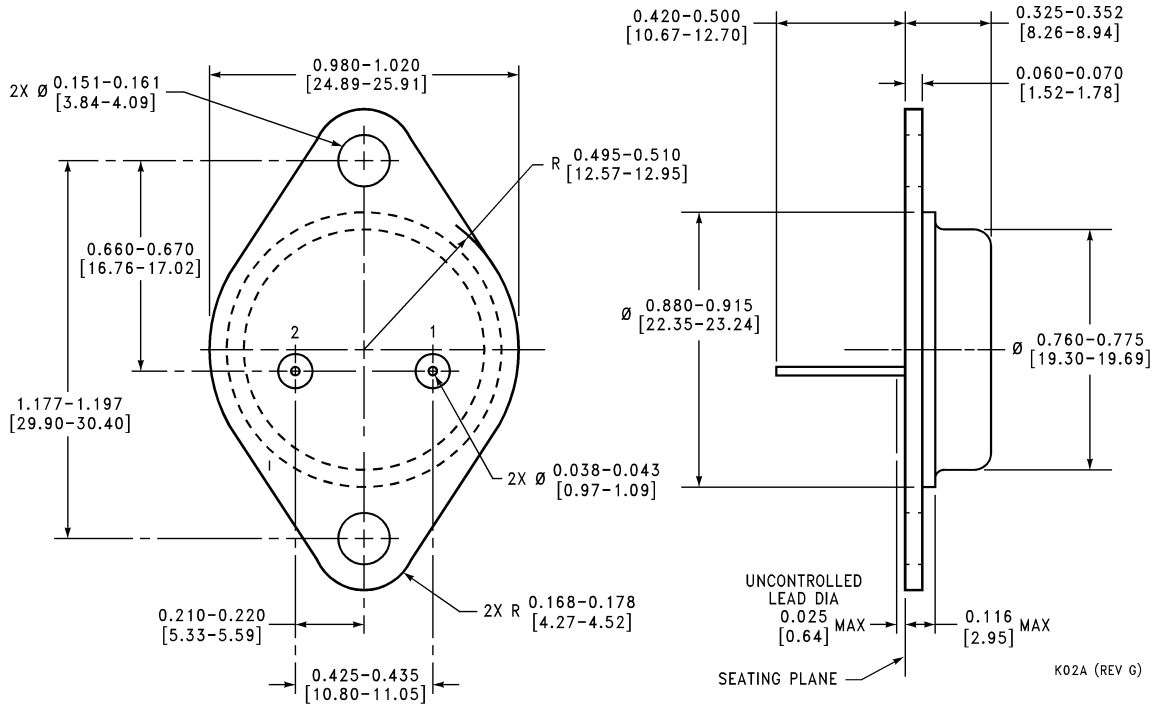

TO-3 Metal Can Package (K)
NS Package Number K02A

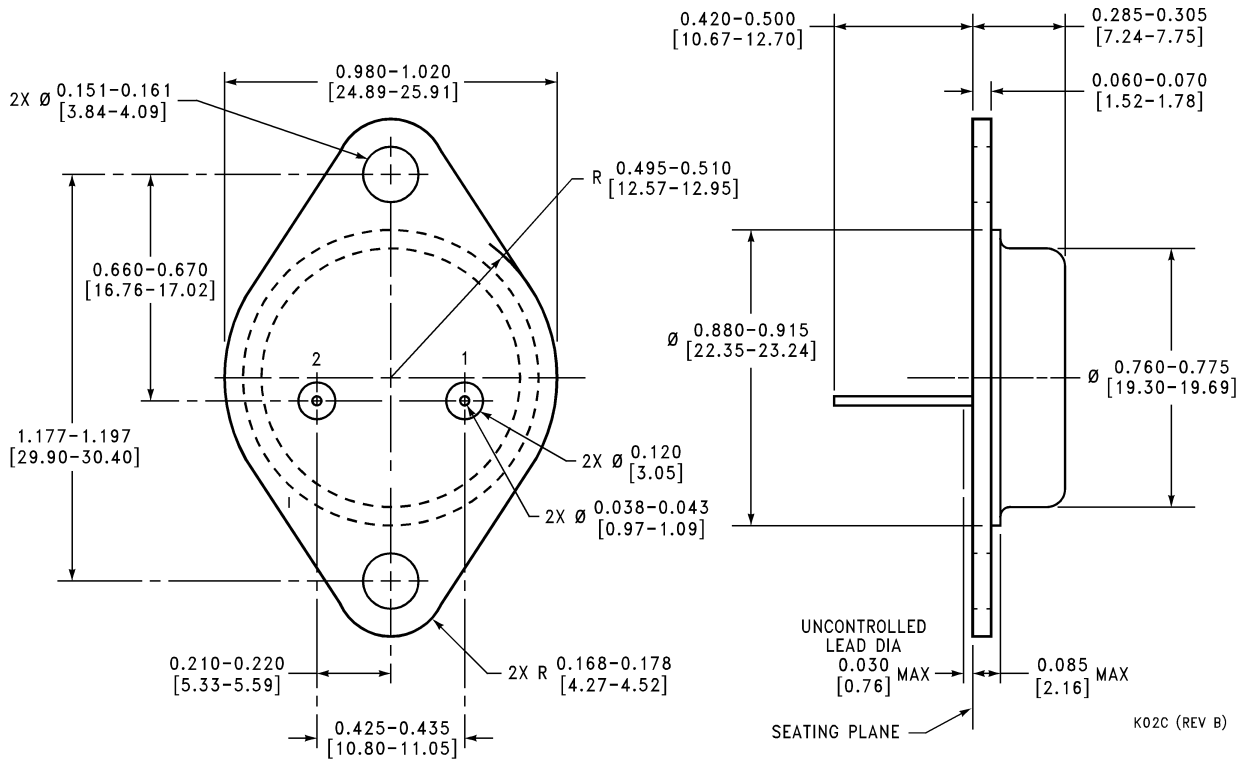

TO-3 Metal Can Package (K)
Mil-Aero Product
NS Package Number K02C

Physical Dimensions inches (millimeters) unless otherwise noted (Continued)

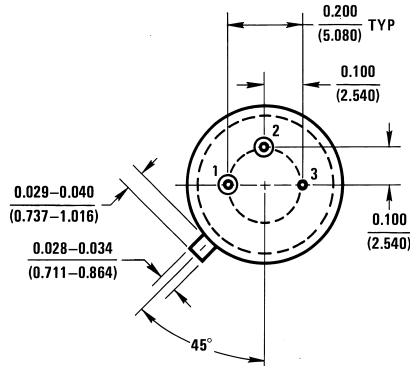
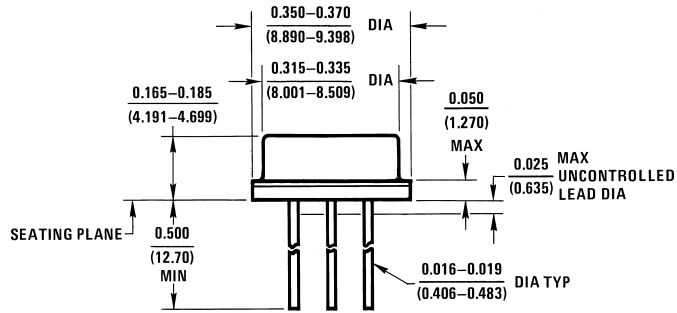

H03A (REV B)

(TO-39) Metal Can Package
NS Package Number H03A

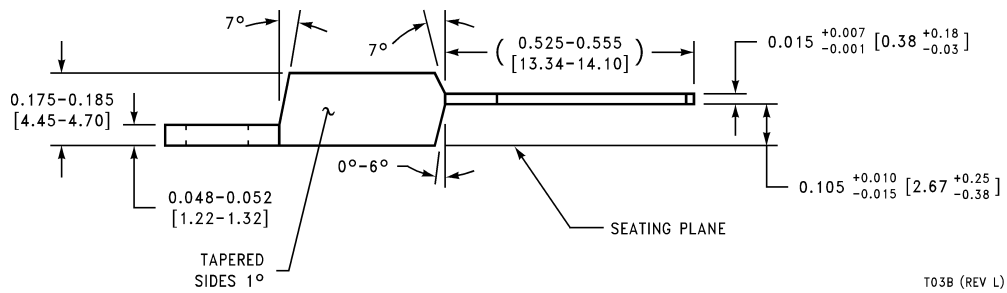
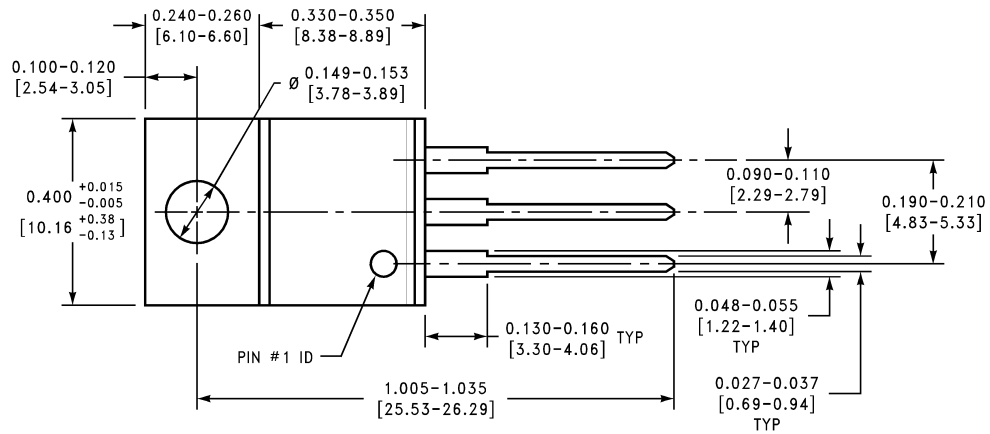

T03B (REV L)

3-Lead TO-220
NS Package Number T03B

Physical Dimensions inches (millimeters) unless otherwise noted (Continued)

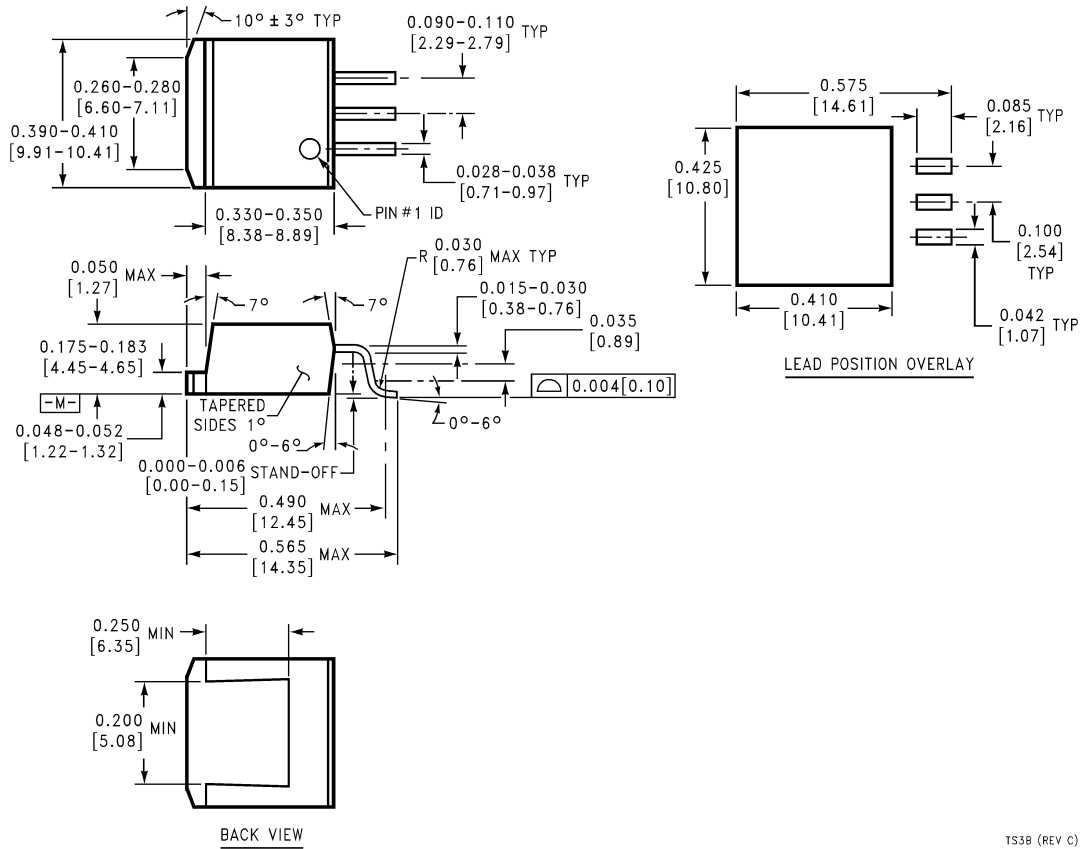

3-Lead TO-263
NS Package Number TS3B

TS3B (REV C)

Physical Dimensions inches (millimeters) unless otherwise noted (Continued)

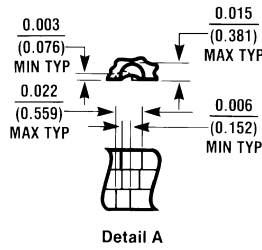
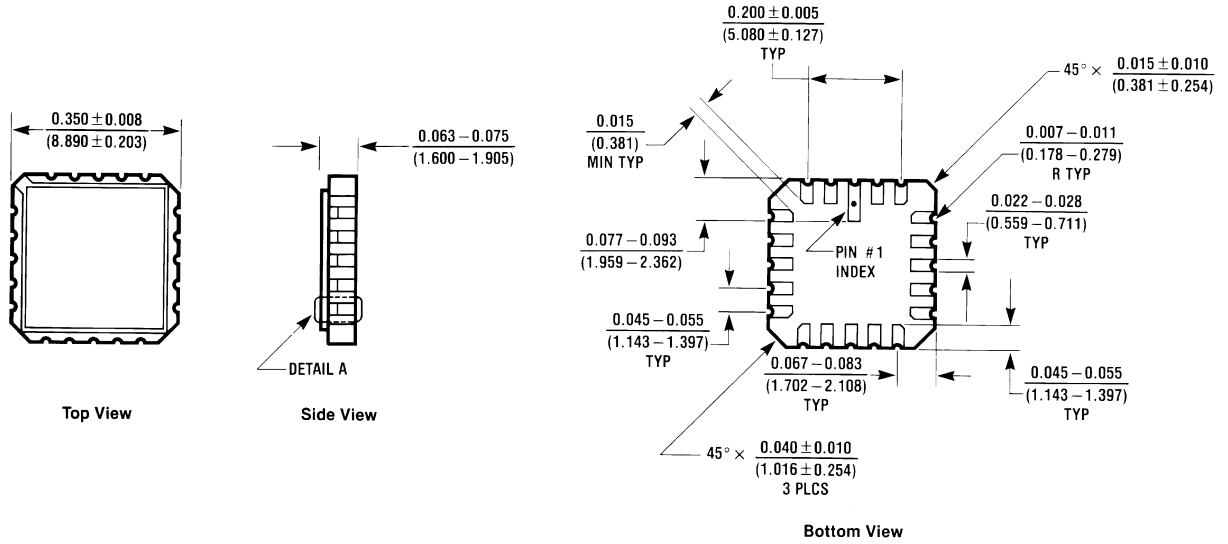

E20A (REV D)

**Ceramic Leadless Chip Carrier
 NS Package Number E20A**

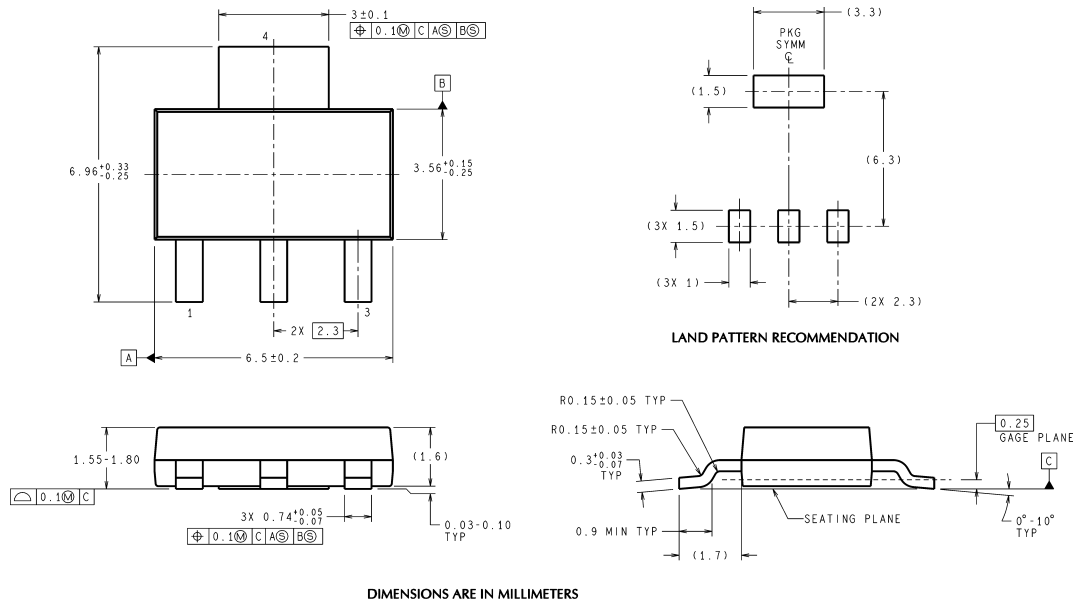

DIMENSIONS ARE IN MILLIMETERS

MP04A (Rev B)

**4-Lead SOT-223
 NS Package Number MP04A**

Physical Dimensions inches (millimeters) unless otherwise noted (Continued)

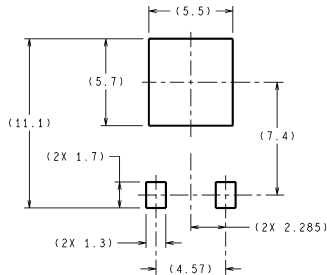

DIMENSIONS ARE IN MILLIMETERS

LAND PATTERN RECOMMENDATION

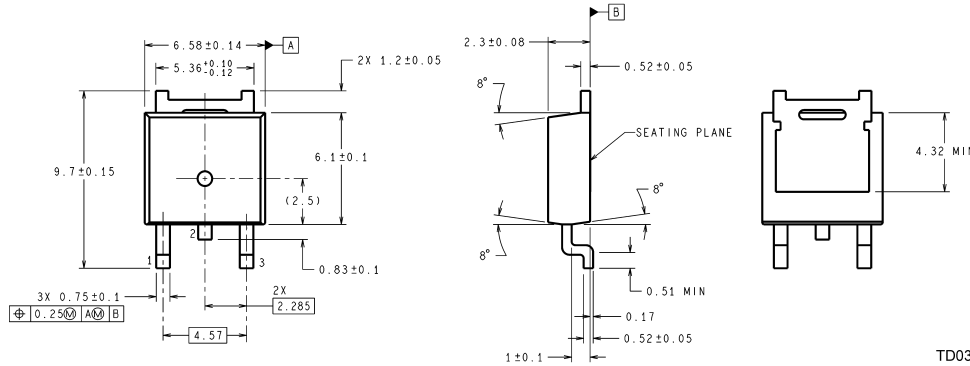

TD03B (Rev C)

**3-Lead D-Pack
NS Package Number TD03B**

LIFE SUPPORT POLICY

NATIONAL'S PRODUCTS ARE NOT AUTHORIZED FOR USE AS CRITICAL COMPONENTS IN LIFE SUPPORT DEVICES OR SYSTEMS WITHOUT THE EXPRESS WRITTEN APPROVAL OF THE PRESIDENT AND GENERAL COUNSEL OF NATIONAL SEMICONDUCTOR CORPORATION. As used herein:

1. Life support devices or systems are devices or systems which, (a) are intended for surgical implant into the body, or (b) support or sustain life, and whose failure to perform when properly used in accordance with instructions for use provided in the labeling, can be reasonably expected to result in a significant injury to the user.
2. A critical component is any component of a life support device or system whose failure to perform can be reasonably expected to cause the failure of the life support device or system, or to affect its safety or effectiveness.

BANNED SUBSTANCE COMPLIANCE

National Semiconductor certifies that the products and packing materials meet the provisions of the Customer Products Stewardship Specification (CSP-9-111C2) and the Banned Substances and Materials of Interest Specification (CSP-9-111S2) and contain no "Banned Substances" as defined in CSP-9-111S2.



National Semiconductor
Americas Customer
Support Center
Email: new.feedback@nsc.com
Tel: 1-800-272-9959

National Semiconductor
Europe Customer Support Center
Fax: +49 (0) 180-530 85 86
Email: europe.support@nsc.com
Deutsch Tel: +49 (0) 69 9508 6208
English Tel: +44 (0) 870 24 0 2171
Français Tel: +33 (0) 1 41 91 8790

National Semiconductor
Asia Pacific Customer
Support Center
Email: ap.support@nsc.com

National Semiconductor
Japan Customer Support Center
Fax: 81-3-5639-7507
Email: jpn.feedback@nsc.com
Tel: 81-3-5639-7560

www.national.com