

LM319

Dual Comparator

Features

- Operates from a single 5V supply
- Typically 80ns response time at $\pm 15V$
- Open collector outputs : up to + 35V
- High output drive current : 25mA
- Inputs and outputs can be isolated from system ground
- Minimum fan-out of 2 (each side)
- Two independent comparators

Description

The LM319 is a dual high speed voltage comparator designed to operate from a single + 5V supply up to $\pm 15V$ dual supplies. Open collector of the output stage makes the LM319 compatible with RTL, DTL and TTL as well as capable of driving lamps and relays at currents up to 25mA. Typical response time of 80ns with $\pm 15V$ power supplies makes the LM319 ideal for application in fast A/D converts, level shifters, oscillators, and multivibrators.

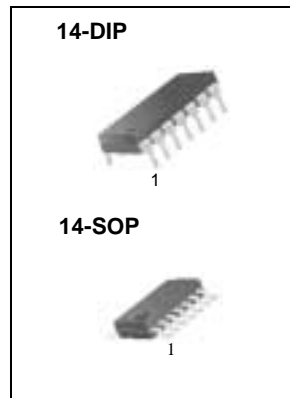

Internal Block Diagram

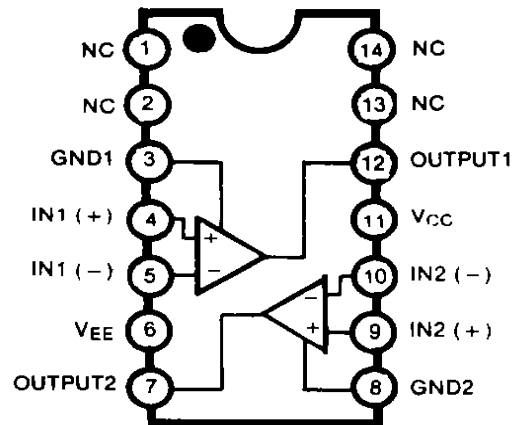

Schematic Diagram

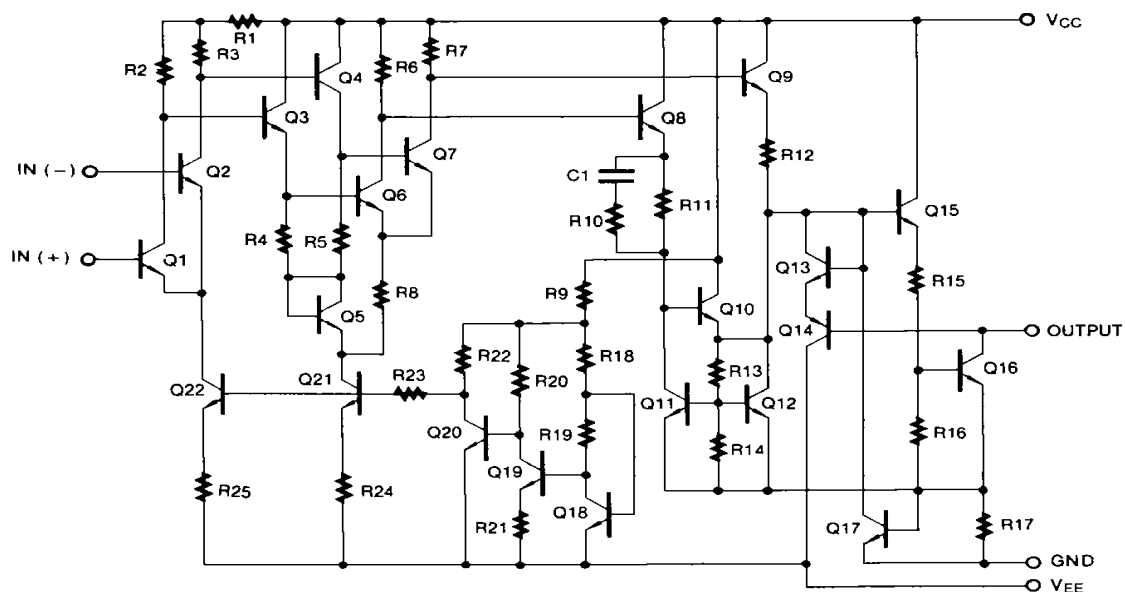

Absolute Maximum Ratings

| Parameter | Symbol | Value | Unit |
|-----------------------------------|----------|-------------|------|
| Supply Voltage | VCC | 36 | V |
| Output to Negative Supply Voltage | VO - VEE | 36 | V |
| Ground to Negative Supply Voltage | VEE | 25 | V |
| Ground to Positive Supply Voltage | VCC | 18 | V |
| Differential Input Voltage | VI(DIFF) | 5 | V |
| Input Voltage | VI | ±15 | V |
| Output Short Circuit Duration | - | 10 | sec |
| Power Dissipation | PD | 500 | mW |
| Operating Temperature Range | TOPR | 0 ~ + 70 | °C |
| Storage Temperature Range | TSTG | -65 ~ + 150 | °C |

Electrical Characteristics

($V_{CC} = +15V$, $V_{EE} = -15V$, $T_A = 25^\circ C$, unless otherwise specified)

| Parameter | Symbol | Conditions | LM319 | | | Unit | |
|-------------------------------|---------------|--|----------------------------|------|----------|---------|---|
| | | | Min. | Typ. | Max. | | |
| Input Offset Voltage (Note 1) | V_{IO} | $R_S \leq 5K\Omega$ Note 3 | - | 2.0 | 8.0 | mV | |
| | | | - | - | 10 | | |
| Input Offset Current (Note 1) | I_{IO} | Note 3 | - | 10 | 200 | nA | |
| | | | - | - | 300 | | |
| Input Bias Current | I_{BIAS} | Note 3 | - | 150 | 1000 | nA | |
| | | | - | - | 1200 | | |
| Voltage Gain | G_V | - | 8 | 40 | - | V/mV | |
| Response Time (Note 2) | T_{RES} | $V_{CC} = \pm 15V$ | - | 80 | - | ns | |
| Saturation Voltage | V_{SAT} | $V_{CC} = 15V, V_{EE} = -15V, V_I \leq -5mV, I_O = 25mA$ | - | 0.6 | 1.5 | V | |
| | | $V_{CC} = 4.5V, V_{EE} = 0V$ $V_I \leq -10mV, I_O \leq 3.2mA$ Note 3 | - | 0.3 | 0.4 | | |
| Output Leakage Current | $I_{O(LKG)}$ | $V_I \geq 5mV, V_{O(P)} = 35V$ Note 3 | - | - | - | μA | |
| | | $V_I \geq 10mV, V_{O(P)} = 35V$ | - | 0.2 | 10 | | |
| Input Voltage Range | $V_{I(R)}$ | Note 3 | $V_{CC} = \pm 15V$ | - | ± 13 | - | V |
| | | | $V_{CC} = 5V, V_{EE} = 0V$ | 1 | - | 3 | |
| Differential Input Voltage | $V_{I(DIFF)}$ | - | - | - | ± 5 | V | |
| Positive Supply Current | I_{CC1} | $V_{CC} = 5V, V_{EE} = 0V$ | - | 3.6 | - | mA | |
| Positive Supply Current | I_{CC2} | $V_{CC} = \pm 15V$ | - | 7.5 | 12.5 | mA | |
| Negative Supply Current | I_{EE} | $V_{CC} = \pm 15V$ | - | 3 | 5 | mA | |

Notes :

- The offset voltage and offset currents given are the maximum values required to drive the output within a volt of either supply with a 1mA load. Thus, these parameters define an error band and take into account the worst case effects of voltage gain and input impedance.
- The response time specified is for a 100mV input step with 5mV overdrive.
- LM319 : $0 \leq T_A \leq +70^\circ C$

Typical Performance Characteristics

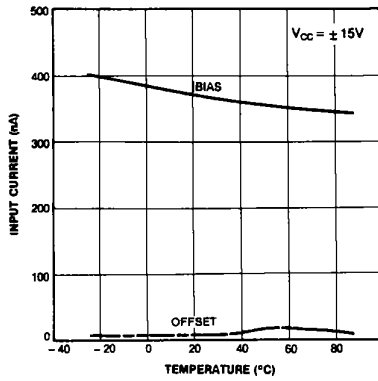

Figure 1. Input Current

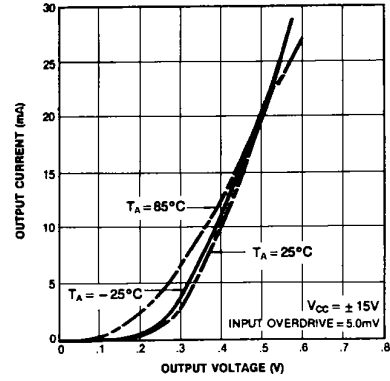

Figure 2. Output Saturation Voltage

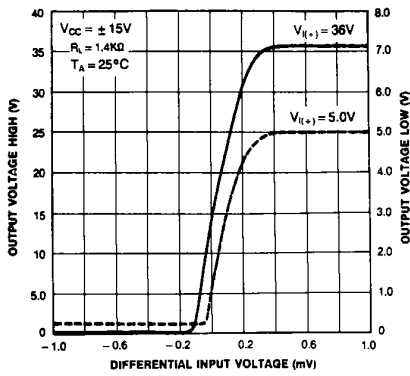

Figure 3. Transfer Function

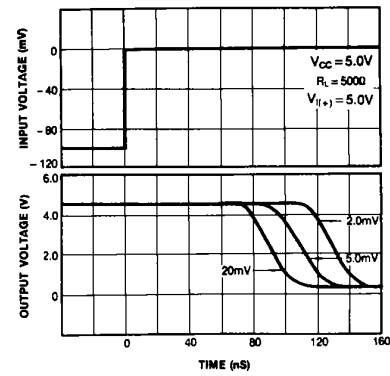

Figure 4. Response Time for Various Input Overdriver

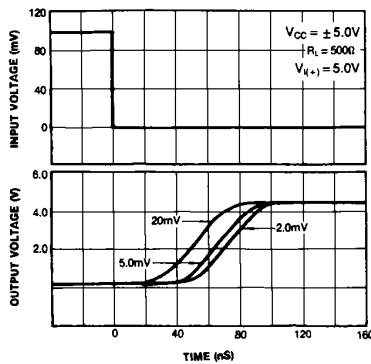

Figure 5. Response Time Various Input Overdriver

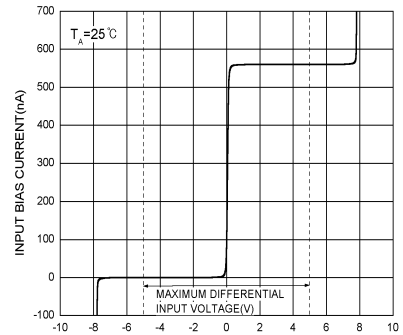

Figure 6. Input Characteristics

Typical Performance Characteristics (continued)

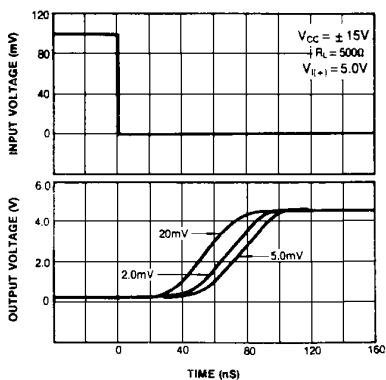

Figure 7. Response Time for Various Input Overdriver

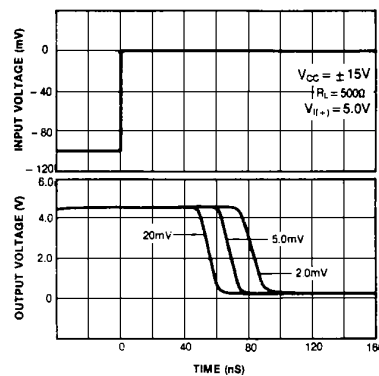

Figure 8. Response Time for Various Input Overdriver

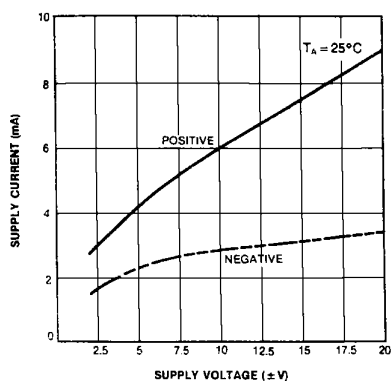

Figure 9. Supply Current

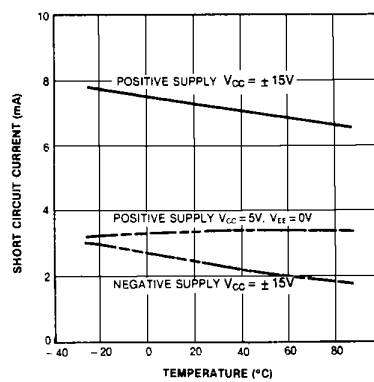

Figure 10. Supply Current

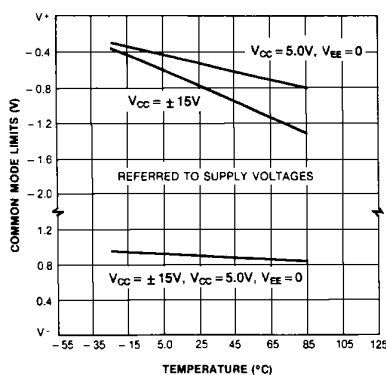

Figure 11. Common Mode Limits

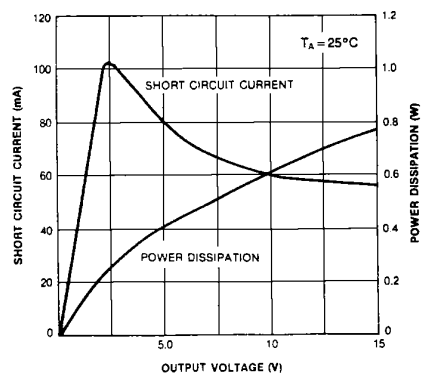

Figure 12. Output Limiting Characteristics

Mechanical Dimensions

Package

Dimensions in millimeters

14-DIP

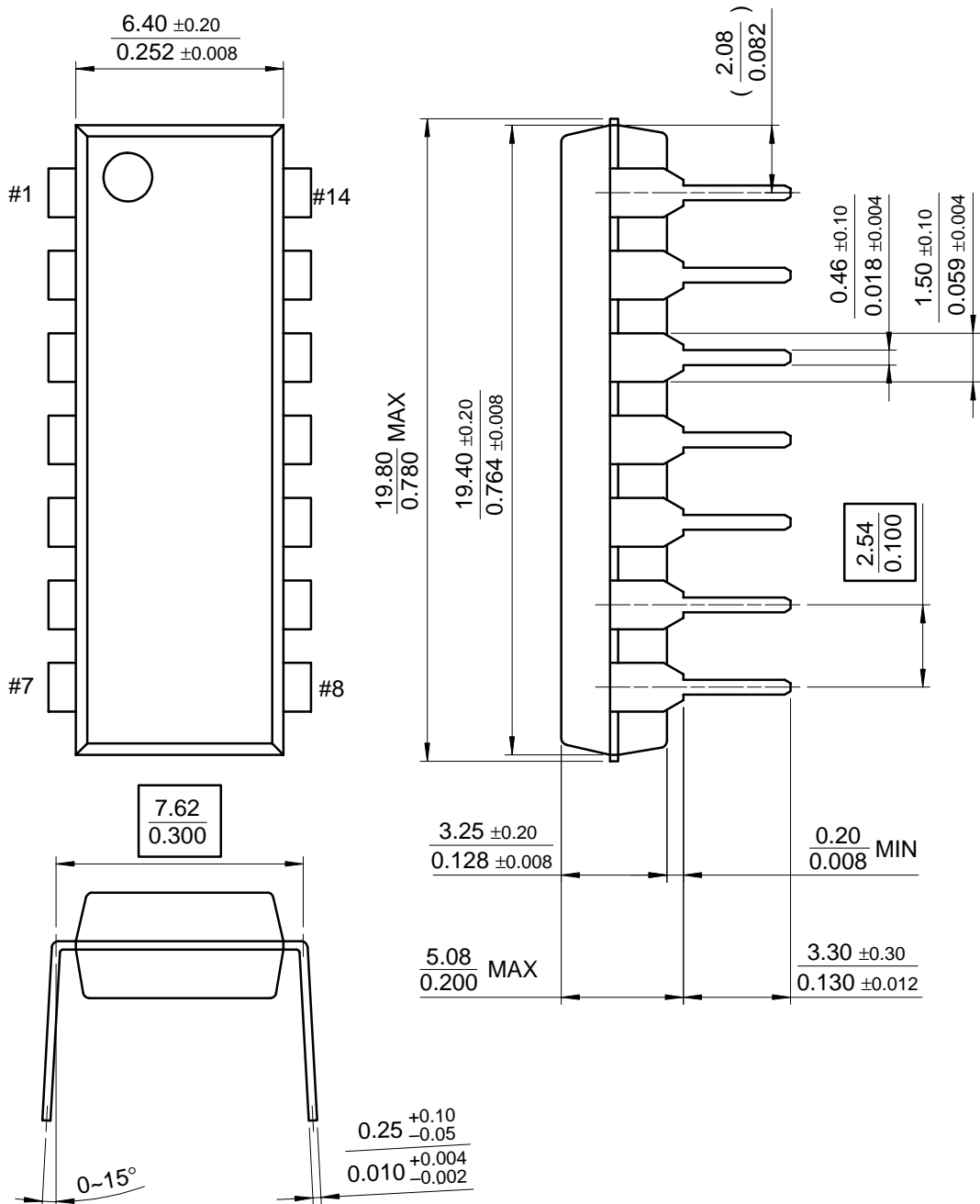

Ordering Information

| Product Number | Package | Operating Temperature |
|-----------------------|----------------|------------------------------|
| LM319N | 14-DIP | 0 ~ + 70°C |
| LM319M | 14-SOP | |

DISCLAIMER

FAIRCHILD SEMICONDUCTOR RESERVES THE RIGHT TO MAKE CHANGES WITHOUT FURTHER NOTICE TO ANY PRODUCTS HEREIN TO IMPROVE RELIABILITY, FUNCTION OR DESIGN. FAIRCHILD DOES NOT ASSUME ANY LIABILITY ARISING OUT OF THE APPLICATION OR USE OF ANY PRODUCT OR CIRCUIT DESCRIBED HEREIN; NEITHER DOES IT CONVEY ANY LICENSE UNDER ITS PATENT RIGHTS, NOR THE RIGHTS OF OTHERS.

LIFE SUPPORT POLICY

FAIRCHILD'S PRODUCTS ARE NOT AUTHORIZED FOR USE AS CRITICAL COMPONENTS IN LIFE SUPPORT DEVICES OR SYSTEMS WITHOUT THE EXPRESS WRITTEN APPROVAL OF THE PRESIDENT OF FAIRCHILD SEMICONDUCTOR CORPORATION. As used herein:

1. Life support devices or systems are devices or systems which, (a) are intended for surgical implant into the body, or (b) support or sustain life, and (c) whose failure to perform when properly used in accordance with instructions for use provided in the labeling, can be reasonably expected to result in a significant injury of the user.
2. A critical component in any component of a life support device or system whose failure to perform can be reasonably expected to cause the failure of the life support device or system, or to affect its safety or effectiveness.