

FEATURES

- S8 Package – Standard Pinout
- Offset Voltage – Prime Grade: 60 μ V Max
- Offset Voltage – Low Cost Grade (Including Surface Mount Dual/Quad): 75 μ V Max
- Offset Voltage Drift: 0.5 μ V/ $^{\circ}$ C Max
- Input Bias Current: 250pA Max
- 0.1Hz to 10Hz Noise: 0.3 μ V_{P-P}, 2.2pA_{P-P}
- Supply Current per Amplifier: 400 μ A Max
- CMRR: 120dB Min
- Voltage Gain: 1 Million Min
- Guaranteed Specs with \pm 1.0V Supplies
- Guaranteed Matching Specifications
- LT1114 in Narrow Surface Mount Package

APPLICATIONS

- Picoampere/Microvolt Instrumentation
- Two and Three Op Amp Instrumentation Amplifiers
- Thermocouple and Bridge Amplifiers
- Low Frequency Active Filters
- Photo Current Amplifiers
- Battery-Powered Systems

DESCRIPTION

The LT1112 dual and LT1114 quad op amps achieve a new standard in combining low cost and outstanding precision specifications.

The performance of the selected prime grades matches or exceeds competitive devices. In the design of the LT1112/LT1114 however, particular emphasis has been placed on optimizing performance in the low cost plastic and SO packages. For example, the 75 μ V maximum offset voltage in these low cost packages is the lowest on any dual or quad non-chopper op amp.

The LT1112/LT1114 also provide a full set of matching specifications, facilitating their use in such matching dependent applications as two and three op amp instrumentation amplifiers.

Another set of specifications is furnished at \pm 1V supplies. This, combined with the low 320 μ A supply current per amplifier, allows the LT1112/LT1114 to be powered by two nearly discharged AA cells.

Protected by U.S. Patents 4,575,685; 4,775,884 and 4,837,496

Dual Output, Buffered Reference (On Single 3V Supply)

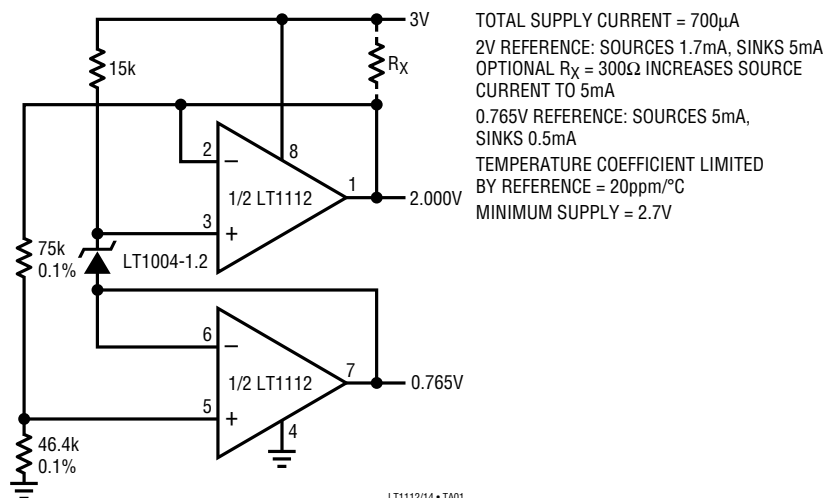

Distribution of Input Offset Voltage (In All Packages)

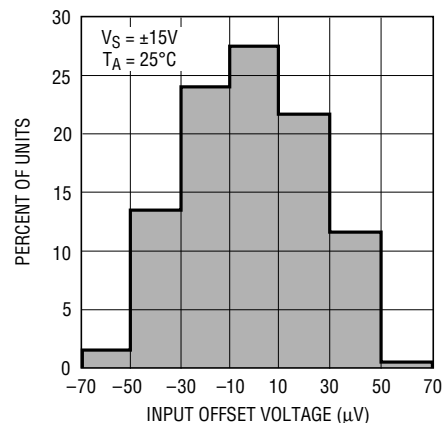

ABSOLUTE MAXIMUM RATINGS

Supply Voltage $\pm 20V$
 Differential Input Current (Note 1) $\pm 10mA$
 Input Voltage (Equal to Supply Voltage) $\pm 20V$
 Output Short-Circuit Duration Indefinite
 Storage Temperature Range $-65^{\circ}C$ to $150^{\circ}C$
 Lead Temperature (Soldering, 10 sec) $300^{\circ}C$

Operating Temperature Range
 LT1112AM/LT1112M
 LT1114AM/LT1114M $-55^{\circ}C$ to $125^{\circ}C$
 LT1112AC/LT1112C/LT1112S8
 LT1114AC/LT1114C/LT1114S $-40^{\circ}C$ to $85^{\circ}C$

PACKAGE/ORDER INFORMATION

<p>J8 PACKAGE 8-LEAD CERAMIC DIP</p> <p>N8 PACKAGE 8-LEAD PLASTIC DIP</p> <p>$T_{JMAX} = 160^{\circ}C, \theta_{JA} = 100^{\circ}C/W$ (J8) $T_{JMAX} = 140^{\circ}C, \theta_{JA} = 130^{\circ}C/W$ (N8)</p>	<p>ORDER PART NUMBER</p> <p>LT1112AMJ8 LT1112MJ8 LT1112ACN8 LT1112CN8</p>	<p>S8 PACKAGE 8-LEAD PLASTIC SO</p> <p>$T_{JMAX} = 140^{\circ}C, \theta_{JA} = 190^{\circ}C/W$</p>	<p>ORDER PART NUMBER</p> <p>LT1112S8</p> <p>PART MARKING</p> <p>1112</p>
<p>J PACKAGE 14-LEAD CERAMIC DIP</p> <p>N PACKAGE 14-LEAD PLASTIC DIP</p> <p>$T_{JMAX} = 160^{\circ}C, \theta_{JA} = 80^{\circ}C/W$ (J) $T_{JMAX} = 140^{\circ}C, \theta_{JA} = 110^{\circ}C/W$ (N)</p>	<p>ORDER PART NUMBER</p> <p>LT1114AMJ LT1114MJ LT1114ACN LT1114CN</p>	<p>S PACKAGE 16-LEAD PLASTIC SO (NARROW)</p> <p>$T_{JMAX} = 140^{\circ}C, \theta_{JA} = 150^{\circ}C/W$</p>	<p>ORDER PART NUMBER</p> <p>LT1114S</p>

ELECTRICAL CHARACTERISTICS $V_S = \pm 15V, V_{CM} = 0V, T_A = 25^{\circ}C$, unless otherwise noted.

SYMBOL	PARAMETER	CONDITIONS (Note 2)	LT1112AM/AC LT1114AM/AC			LT1112M/C/S8 LT1114M/C/S			UNITS
			MIN	TYP	MAX	MIN	TYP	MAX	
V_{OS}	Input Offset Voltage	$V_S = \pm 1.0V$		20	60		25	75	μV
				40	110		45	130	μV
$\frac{\Delta V_{OS}}{\Delta Time}$	Long Term Input Offset Voltage Stability			0.3			0.3		$\mu V/Mo$
I_{OS}	Input Offset Current	LT1114S		50	180		60	230	ρA
							75	330	ρA
I_B	Input Bias Current	LT1114S		± 70	± 250		± 80	± 280	ρA
							± 100	± 450	ρA
e_n	Input Noise Voltage	0.1Hz to 10Hz (Note 9)		0.3	0.9		0.3	0.9	μV_{P-P}

ELECTRICAL CHARACTERISTICS $V_S = \pm 15V$, $V_{CM} = 0V$, $T_A = 25^\circ C$, unless otherwise noted.

SYMBOL	PARAMETER	CONDITIONS (Note 2)	LT1112AM/AC LT1114AM/AC			LT1112M/C/S8 LT1114M/C/S			UNITS
			MIN	TYP	MAX	MIN	TYP	MAX	
	Input Noise Voltage Density	$f_0 = 10\text{Hz}$ (Note 9) $f_0 = 1000\text{Hz}$ (Note 9)		16 14	28 18		16 14	28 18	$nV/\sqrt{\text{Hz}}$ $nV/\sqrt{\text{Hz}}$
i_n	Input Noise Current	0.1Hz to 10Hz		2.2			2.2		pA_{p-p}
	Input Noise Current Density	$f_0 = 10\text{Hz}$ $f_0 = 1000\text{Hz}$		0.030 0.008			0.030 0.008		$pA/\sqrt{\text{Hz}}$ $pA/\sqrt{\text{Hz}}$
V_{CM}	Input Voltage Range		± 13.5	± 14.3		± 13.5	± 14.3		V
CMRR	Common-Mode Rejection Ratio	$V_{CM} = \pm 13.5V$	120	136		115	136		dB
PSRR	Power Supply Rejection Ratio	$V_S = \pm 1.0V$ to $\pm 20V$	116	126		114	126		dB
	Minimum Supply Voltage	(Note 4)	± 1.0			± 1.0			V
R_{IN}	Input Resistance Differential Mode Common Mode	(Note 3)	20	50 800		15	40 700		$M\Omega$ $G\Omega$
A_{VOL}	Large-Signal Voltage Gain	$V_0 = \pm 12V$, $R_L = 10k\Omega$ $V_0 = \pm 10V$, $R_L = 2k\Omega$	1000 800	5000 1500		800 600	5000 1300		V/mV V/mV
V_{OUT}	Output Voltage Swing	$R_L = 10k\Omega$ $R_L = 2k\Omega$	± 13.0 ± 11.0	± 14.0 ± 12.4		± 13.0 ± 11.0	± 14.0 ± 12.4		V V
SR	Slew Rate		0.16	0.30		0.16	0.30		$V/\mu s$
GBW	Gain-Bandwidth Product	$f_0 = 10\text{kHz}$	450	750		450	750		kHz
I_S	Supply Current per Amplifier	$V_S = \pm 1.0V$		350 320	400 370		350 320	450 420	μA μA
	Channel Separation	$f_0 = 10\text{Hz}$		150			150		dB
ΔV_{OS}	Offset Voltage Match	(Note 5)		35	100		40	130	μV
ΔI_B^+	Noninverting Bias Current Match (Notes 5, 6)	LT1114S		100	450		100 120	500 680	pA pA
$\Delta CMRR$	Common-Mode Rejection Match	(Notes 5, 7)	117	136		113	136		dB
$\Delta PSRR$	Power Supply Rejection Match	(Notes 5, 7)	114	130		112	130		dB

ELECTRICAL CHARACTERISTICS $V_S = \pm 15V$, $-55^\circ C \leq T_A \leq 125^\circ C$, unless otherwise noted.

SYMBOL	PARAMETER	CONDITIONS (Note 2)	LT1112AMJ8 LT1114AMJ			LT1112MJ8 LT1114MJ			UNITS
			MIN	TYP	MAX	MIN	TYP	MAX	
V_{OS}	Input Offset Voltage	$V_S = \pm 1.2V$	●	35	120	●	45	150	μV
			●	60	220	●	70	260	μV
$\frac{\Delta V_{OS}}{\Delta \text{Temp}}$	Average Input Offset Voltage Drift	(Note 8)	●	0.15	0.5	●	0.20	0.75	$\mu V/^\circ C$
I_{OS}	Input Offset Current		●	80	400	●	100	500	pA
I_B	Input Bias Current		●	± 150	± 600	●	± 170	± 700	pA
V_{CM}	Input Voltage Range		●	± 13.5	± 14.1	●	± 13.5	± 14.1	V
CMRR	Common-Mode Rejection Ratio	$V_{CM} = \pm 13.5V$	●	116	130	●	111	130	dB
PSRR	Power Supply Rejection Ratio	$V_S = \pm 1.2V$ to $\pm 20V$	●	112	124	●	110	124	dB
A_{VOL}	Large-Signal Voltage Gain	$V_0 = \pm 12V$, $R_L = 10k\Omega$ $V_0 = \pm 10V$, $R_L = 2k\Omega$	●	500	2500	●	400	2500	V/mV
			●	200	600	●	170	500	V/mV

ELECTRICAL CHARACTERISTICS $V_S = \pm 15V, -55^\circ C \leq T_A \leq 125^\circ C$, unless otherwise noted.

SYMBOL	PARAMETER	CONDITIONS (Note 2)		LT1112AMJ8 LT1114AMJ			LT1112MJ8 LT1114MJ			UNITS
				MIN	TYP	MAX	MIN	TYP	MAX	
V_{OUT}	Output Voltage Swing	$R_L = 10k\Omega$	●	± 13.0	± 13.85		± 13.0	± 13.85	V	
SR	Slew Rate		●	0.12	0.22		0.12	0.22	V/ μs	
I_S	Supply Current per Amplifier		●		380	460		380	530	μA
ΔV_{OS}	Offset Voltage Match	(Note 5)	●		55	200		70	240	μV
	Offset Voltage Match Drift	(Notes 5, 8)	●		0.2	0.7		0.3	1.0	$\mu V/^\circ C$
ΔI_B^+	Noninverting Bias Current Match	(Notes 5, 6)	●		150	750		170	850	pA
$\Delta CMRR$	Common-Mode Rejection Ratio	(Notes 5, 7)	●	112	130		106	130	dB	
$\Delta PSRR$	Power Supply Rejection Ratio	(Notes 5, 7)	●	109	126		106	126	dB	

ELECTRICAL CHARACTERISTICS $V_S = \pm 15V, 0^\circ C \leq T_A \leq 70^\circ C$, unless otherwise noted.

SYMBOL	PARAMETER	CONDITIONS (Note 2)		LT1112ACN8 LT1114ACN			LT1112N8/S8 LT1114CN/S			UNITS
				MIN	TYP	MAX	MIN	TYP	MAX	
V_{OS}	Input Offset Voltage	LT1112N8	●		27	100		30	125	μV
		LT1112S8, LT1114N/S	●		35	125		45	150	μV
		$V_S = \pm 1.2V$	●		50	175		65	210	μV
$\frac{\Delta V_{OS}}{\Delta Temp}$	Average Input Offset Voltage Drift (Note 8)	LT1112N8	●		0.15	0.5		0.2	0.75	$\mu V/^\circ C$
		LT1112S8, LT1114N/S	●		0.3	1.1		0.4	1.3	$\mu V/^\circ C$
I_{OS}	Input Offset Current	LT1112N8	●		60	220		70	290	pA
		LT1114S	●					90	420	pA
I_B	Input Bias Current	LT1112N8	●		± 80	± 300		± 90	± 350	pA
		LT1114S	●					± 115	± 550	pA
V_{CM}	Input Voltage Range		●	± 13.5	± 14.2		± 13.5	± 14.2	V	
CMRR	Common-Mode Rejection Ratio	$V_{CM} = \pm 13.5V$	●	118	133		113	133	dB	
PSRR	Power Supply Rejection Ratio	$V_S = \pm 1.2V$ to $\pm 20V$	●	114	125		112	125	dB	
A_{VOL}	Large-Signal Voltage Gain	$V_O = \pm 12V, R_L = 10k\Omega$	●	800	4000		650	4000	V/mV	
		$V_O = \pm 10V, R_L = 2k\Omega$	●	500	1300		400	1000	V/mV	
V_{OUT}	Output Voltage Swing	$R_L = 10k\Omega$	●	± 13.0	± 13.9		± 13.0	± 13.9	V	
SR	Slew Rate		●	0.14	0.27		0.14	0.27	V/ μs	
I_S	Supply Current per Amplifier		●		370	440		370	500	μA
ΔV_{OS}	Offset Voltage Match (Note 5)	LT1112N8	●		45	170		55	210	μV
		LT1112S8, LT1114N/S	●		55	220		70	270	μV
	Offset Voltage Match Drift (Notes 5, 8)	LT1112N8	●		0.2	0.7		0.3	1.0	$\mu V/^\circ C$
		LT1112S8, LT1114N/S	●		0.4	1.6		0.5	1.9	$\mu V/^\circ C$
ΔI_B^+	Noninverting Bias Current Match (Notes 5, 6)	LT1112N8	●		120	530		135	620	pA
		LT1114S	●					160	880	pA
$\Delta CMRR$	Common-Mode Rejection Ratio	(Notes 5, 7)	●	114	134		109	134	dB	
$\Delta PSRR$	Power Supply Rejection Ratio	(Notes 5, 7)	●	110	128		108	128	dB	

ELECTRICAL CHARACTERISTICS $V_S = \pm 15V, -40^{\circ}C \leq T_A \leq 85^{\circ}C$, (Note 10)

SYMBOL	PARAMETER	CONDITIONS (Note 2)	LT1112ACN8 LT1114ACN			LT1112N8/S8 LT1114CN/S			UNITS
			MIN	TYP	MAX	MIN	TYP	MAX	
V_{OS}	Input Offset Voltage	LT1112N8	●	30	110	35	135	μV	
		LT1112S8, LT1114N/S	●	40	135	45	160	μV	
		$V_S = \pm 1.2V$	●	55	200	60	240	μV	
$\frac{\Delta V_{OS}}{\Delta Temp}$	Average Input Offset Voltage Drift	LT1112N8	●	0.15	0.50	0.20	0.75	$\mu V/^{\circ}C$	
		LT1112S8, LT1114N/S	●	0.30	1.10	0.40	1.30	$\mu V/^{\circ}C$	
I_{OS}	Input Offset Current	LT1112N8	●	70	330	85	400	μA	
		LT1114S	●			110	600	μA	
I_B	Input Bias Current	LT1112N8	●	± 110	± 500	± 120	± 550	μA	
		LT1114S	●			± 150	± 800	μA	
V_{CM}	Input Voltage Range		●	± 13.5	± 14.1	± 13.5	± 14.1	V	
CMRR	Common-Mode Rejection Ratio	$V_{CM} = \pm 13.5V$	●	117	132	112	132	dB	
PSRR	Power Supply Rejection Ratio	$V_S = \pm 1.2V$ to $\pm 20V$	●	113	125	111	125	dB	
A_{VOL}	Large-Signal Voltage Gain	$V_O = \pm 12V, R_L = 10k\Omega$	●	700	3300	600	3300	V/mV	
		$V_O = \pm 10V, R_L = 2k\Omega$	●	400	1100	300	900	V/mV	
V_{OUT}	Output Voltage Swing	$R_L = 10k\Omega$	●	± 13.0	± 13.85	± 13.0	± 13.85	V	
SR	Slew Rate		●	0.13	0.24	0.13	0.24	V/ μs	
I_S	Supply Current per Amplifier		●	370	450	370	510	μA	
ΔV_{OS}	Offset Voltage Match (Note 5)	LT1112N8	●	50	180	60	225	μV	
		LT1112S8, LT1114N/S	●	60	230	70	270	μV	
	Offset Voltage Match Drift (Notes 5)	LT1112N8	●	0.2	0.7	0.3	1.0	$\mu V/^{\circ}C$	
		LT1112S8, LT1114N/S	●	0.4	1.6	0.5	1.9	$\mu V/^{\circ}C$	
ΔI_B^+	Noninverting Bias Current Match (Notes 5, 6)	LT1112N8	●	140	660	155	770	μA	
		LT1114S	●			190	1300	μA	
$\Delta CMRR$	Common-Mode Rejection Ratio	(Notes 5, 7)	●	113	133	109	133	dB	
$\Delta PSRR$	Power Supply Rejection Ratio	(Notes 5, 7)	●	110	127	107	127	dB	

The ● denotes specifications which apply over the operating temperature range.

Note 1: Differential input voltages greater than 1V will cause excessive current to flow through the input protection diodes unless limiting resistance is used.

Note 2: Typical parameters are defined as the 60% yield of parameter distributions of individual amplifiers; i.e., out of 100 LT1114s (or 100 LT1112s) typically 240 op amps (or 120) will be better than the indicated specification.

Note 3: This parameter is guaranteed by design and is not tested.

Note 4: Offset voltage, supply current and power supply rejection ratio are measured at the minimum supply voltage.

Note 5: Matching parameters are the difference between amplifiers A and D and between B and C on the LT1114; between the two amplifiers on the LT1112.

Note 6: This parameter is the difference between two noninverting input bias currents.

Note 7: $\Delta CMRR$ and $\Delta PSRR$ are defined as follows: (1) CMRR and PSRR are measured in $\mu V/V$ on the individual amplifiers. (2) The difference is calculated between the matching sides in $\mu V/V$. (3) The result is converted to dB.

Note 8: This parameter is not 100% tested.

Note 9: These parameters are not tested. More than 99% of the op amps tested during product characterization have passed the maximum limits. 100% passed at 1kHz.

Note 10: The LT1112/LT1114 are not tested and are not quality assurance sampled at $-40^{\circ}C$ and at $85^{\circ}C$. These specifications are guaranteed by design, correlation and/or inference from $-55^{\circ}C, 0^{\circ}C, 25^{\circ}C, 70^{\circ}C$ and/or $125^{\circ}C$ tests.

TYPICAL PERFORMANCE CHARACTERISTICS

Input Bias and Offset Current, Noninverting Bias Current Match vs Temperature

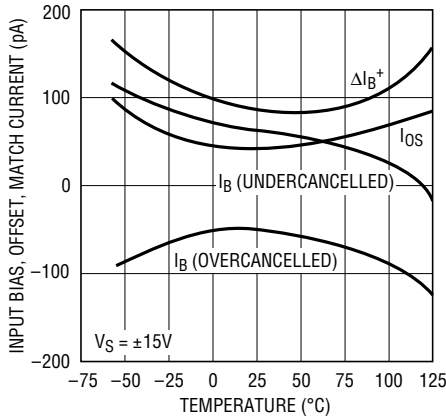

LT1112/14 • TPC01

Input Bias Current Over Common-Mode Range

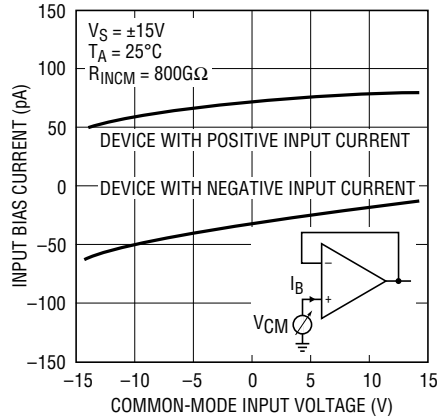

LT1112/14 • TPC02

Distribution of Input Bias Current (In All Packages Except LT1114S)

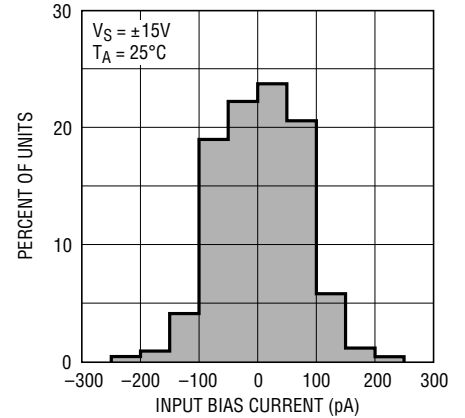

LT1112/14 • TPC03

Drift with Temperature LT1112N8/J8, LT1114J

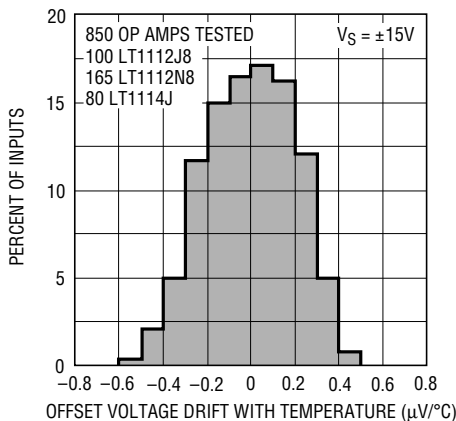

LT1112/14 • TPC04

Drift with Temperature LT1112S8, LT1114N/S

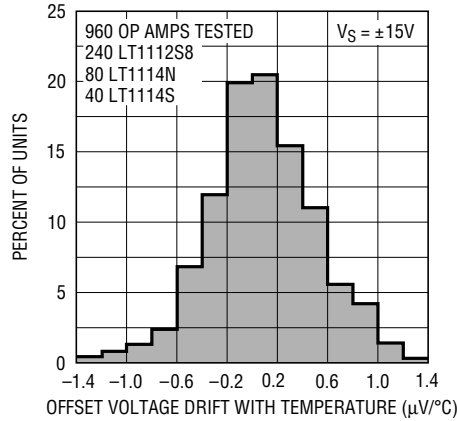

LT1112/14 • TPC05

Distribution of Offset Voltage at V_S = ±1.0V (In All Packages)

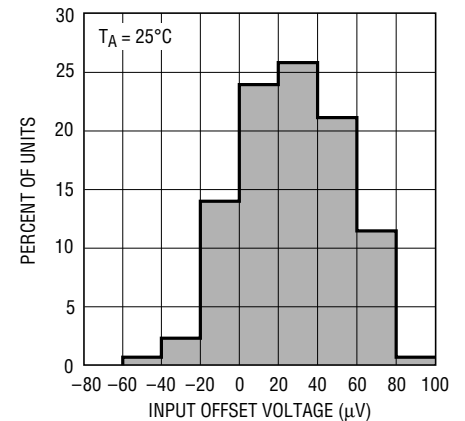

LT1112/14 • TPC06

Distribution of Offset Voltage Match

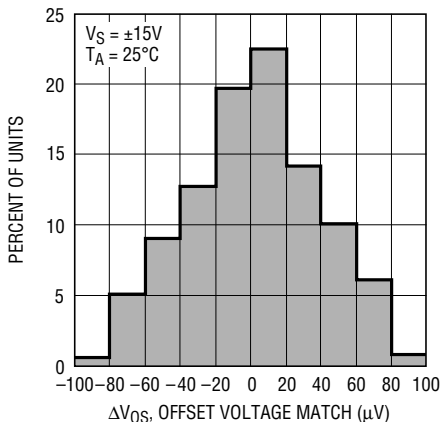

LT1112/14 • TPC07

Distribution of Offset Voltage Match Drift (LT1112J8, LT1112N8, LT1114J Packages)

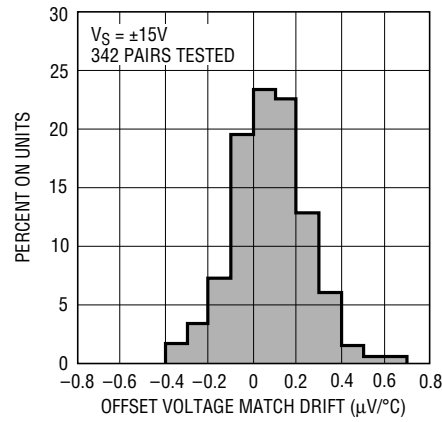

LT1112/14 • TPC08

Distribution of Offset Voltage Match Drift (LT1112S8, LT1114N, LT1114S Packages)

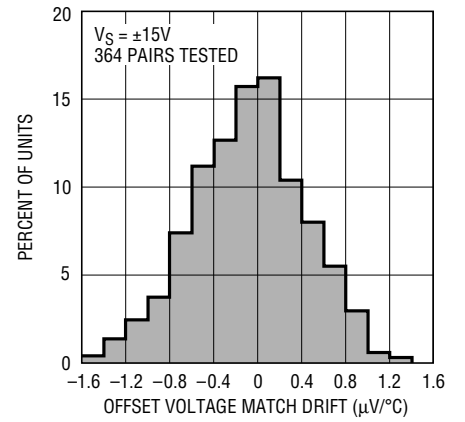

LT1112/14 • TPC09

TYPICAL PERFORMANCE CHARACTERISTICS

Noise Spectrum

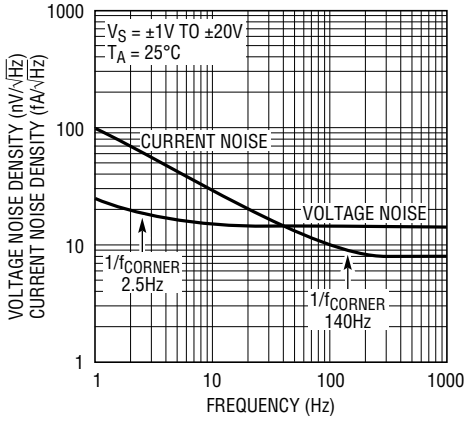

LT1112/14 • TPC10

0.1Hz to 10Hz Noise

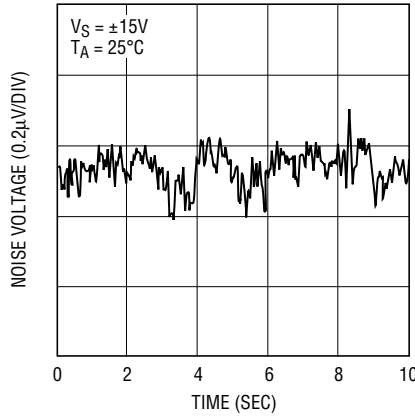

LT1112/14 • TPC11

0.01Hz to 1Hz Noise

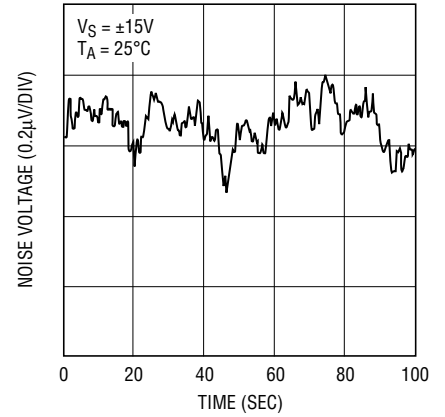

LT1112/14 • TPC12

Warm-Up Drift

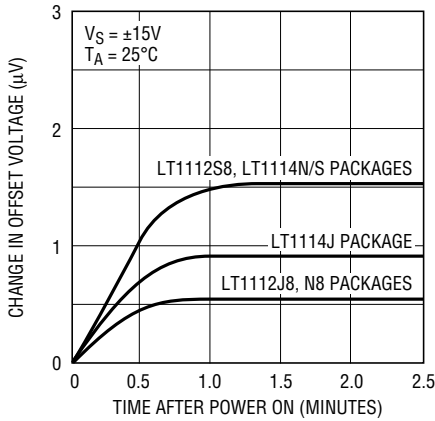

LT1112/14 • TPC13

Long Term Stability of Three Representative Units

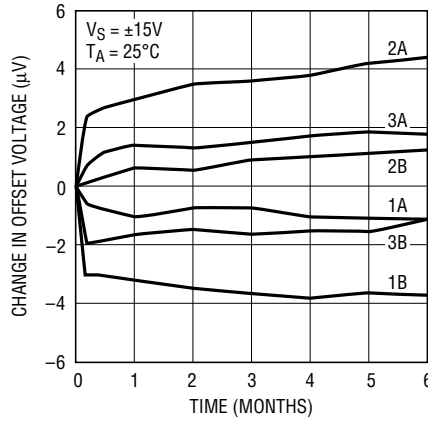

LT1112/14 • TPC14

Supply Current per Amplifier vs Supply Voltage

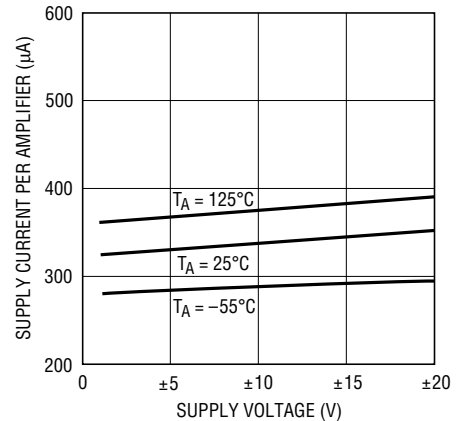

LT1112/14 • TPC15

Minimum Supply Voltage vs Temp Voltage Gain at Minimum Supply Voltage

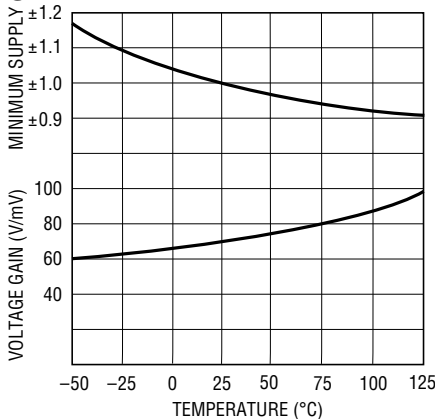

LT1112/14 • TPC16

Common-Mode Range and Voltage Swing with Respect to Supply Voltages

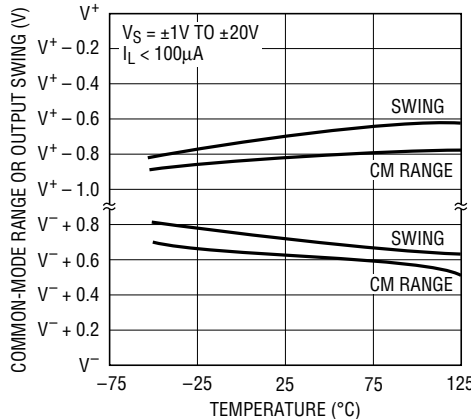

LT1112/14 • TPC17

Output Voltage Swing vs Load Current

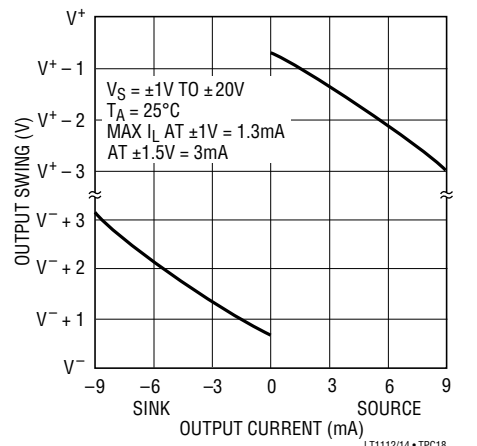

LT1112/14 • TPC18

TYPICAL PERFORMANCE CHARACTERISTICS

Voltage Gain

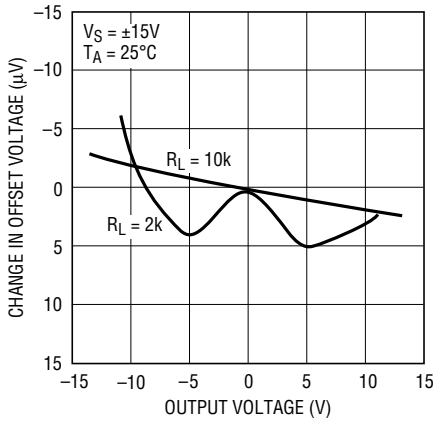

LT1112/14 • TPC19

Voltage Gain vs Frequency

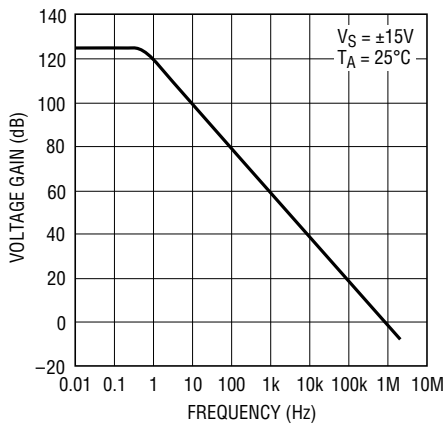

LT1112/14 • TPC20

Gain, Phase Shift vs Frequency

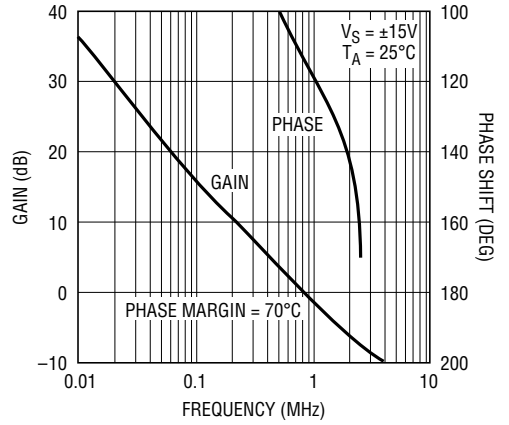

LT1112/14 • TPC21

Common-Mode Rejection vs Frequency

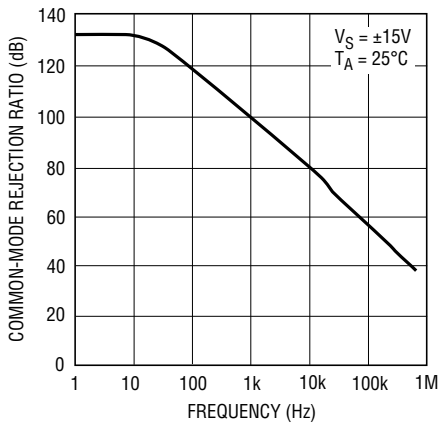

LT1112/14 • TPC22

Power Supply Rejection vs Frequency

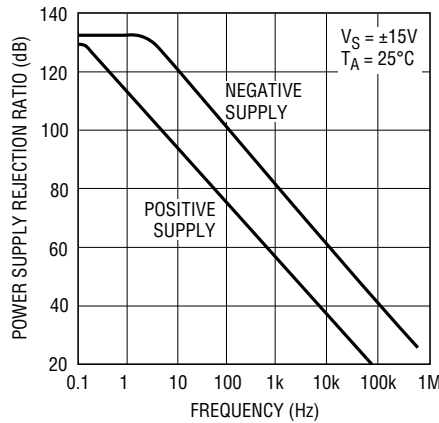

LT1112/14 • TPC23

Channel Separation vs Frequency

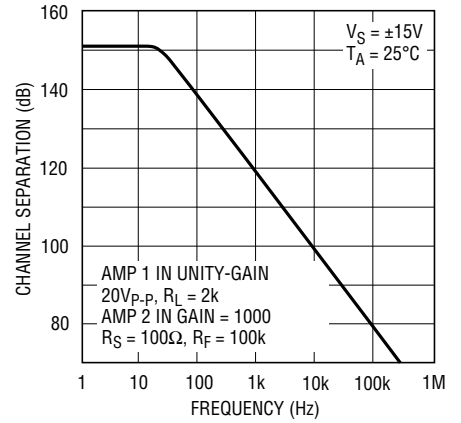

LT1112/14 • TPC24

Slew Rate, Gain-Bandwidth Product and Phase Margin vs Temperature

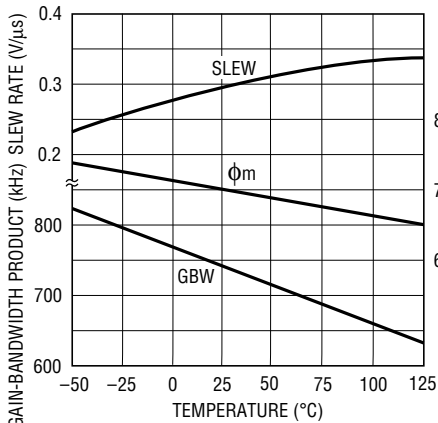

LT1112/14 • TPC25

Closed-Loop Output Impedance

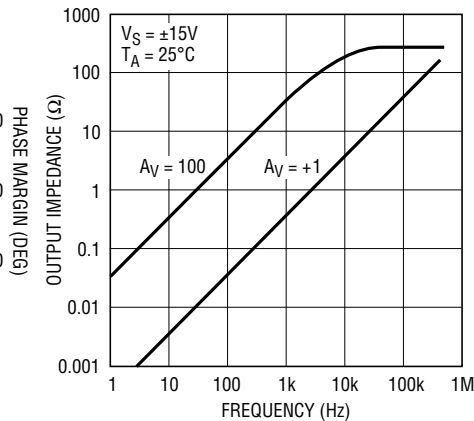

LT1112/14 • TPC26

Capacitive Loading Handling

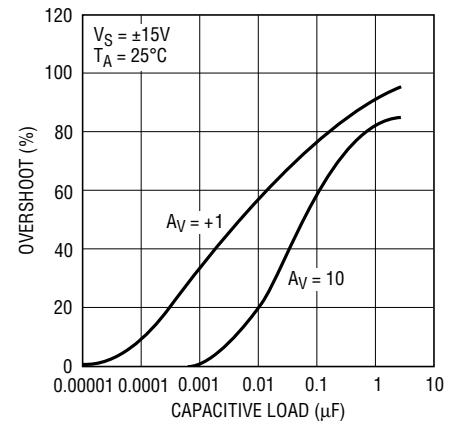

LT1112/14 • TPC27

TYPICAL PERFORMANCE CHARACTERISTICS

Small-Signal Transient Response

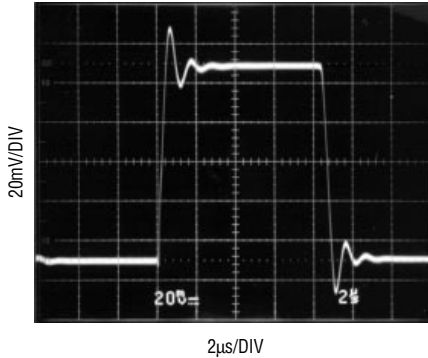

$A_V = +1$
 $C_L = 500\text{pF}$
 $V_S = \pm 15\text{V}$

Large-Signal Transient Response

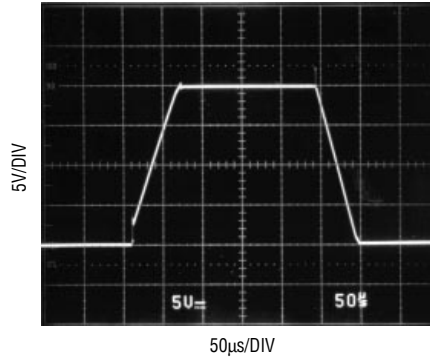

$A_V = +1$
 $R_F = 10\text{k}$
 $C_F = 100\text{pF}$
 $V_S = \pm 15\text{V}$

Undistorted Output Voltage vs Frequency

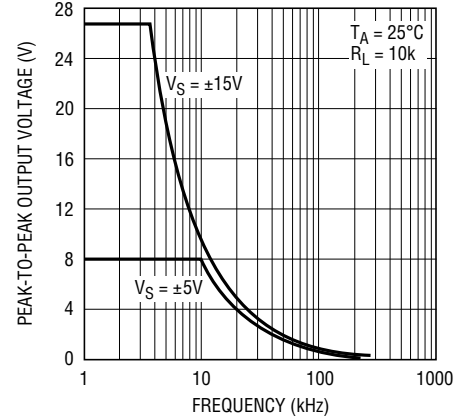

LT1112/14 • TPC30

APPLICATIONS INFORMATION

The LT1112 dual and LT1114 quad in the plastic and ceramic DIP packages are pin compatible to and directly replace such precision op amps as the OP-200, OP-297, AD706 duals and OP-400, OP-497, AD704 quads with improved price/performance.

The LT1112 in the S8 surface mount package has the standard pin configuration, i.e., the same configuration as the plastic and ceramic DIP packages.

The LT1114 quad is offered in the narrow 16-pin surface mount package. All competitors are in the wide 16-pin package which occupies 1.8 times the area of the narrow package. The wide package is also 1.8 times thicker than the narrow package.

The inputs of the LT1112/1114 are protected with back-to-back diodes. In the voltage follower configuration, when

the input is driven by a fast large-signal pulse ($>1\text{V}$), the input protection diodes effectively short the output to the input during slewing, and a current, limited only by the output short-circuit protection, will flow through the diodes.

The use of a feedback resistor is recommended because this resistor keeps the current below the short-circuit limit, resulting in faster recovery and settling of the output.

The input voltage of the LT1112/1114 should never exceed the supply voltages by more than a diode drop. However, the example below shows that as the input voltage exceeds the common-mode range, the LT1112's output clips cleanly, without any glitches or phase reversal. The OP-297 exhibits phase reversal. The photos also illustrate that both the input and output ranges of the LT1112 are within

Voltage Follower with Input Exceeding the Common-Mode Range ($V_S = \pm 5\text{V}$)

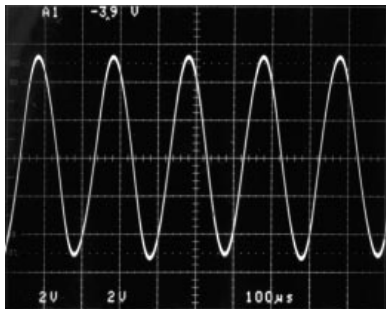

INPUT: $\pm 5.2\text{V}$ Sine Wave

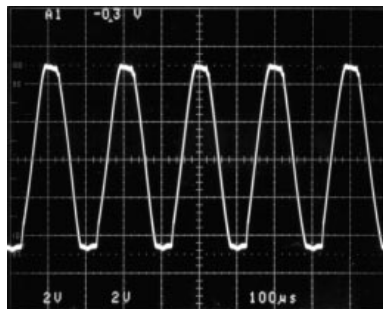

LT1112 Output

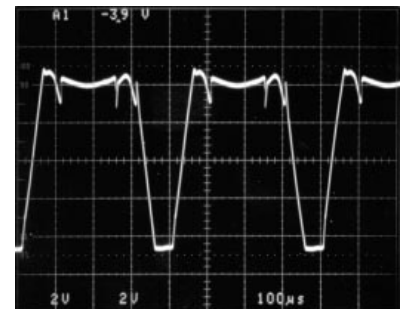

OP-297 Output

APPLICATIONS INFORMATION

800mV of the supplies. The effect of input and output overdrive on the other amplifiers in the LT1112 or LT1114 packages is negligible, as each amplifier is biased independently.

Advantages of Matched Dual and Quad Op Amps

In many applications the performance of a system depends on the matching between two operational amplifiers rather than the individual characteristics of the two op amps. Two or three op amp instrumentation amplifiers, tracking voltage references and low drift active filters are some of the circuits requiring matching between two op amps.

The well-known triple op amp configuration illustrates these concepts. Output offset is a function of the difference between the offsets of the two halves of the LT1112. This error cancellation principle holds for a considerable number of input referred parameters in addition to offset voltage and its drift with temperature. Input bias current will be the average of the two noninverting input currents (I_B^+). The difference between these two currents (ΔI_B^+) is the offset current of the instrumentation amplifier. Common-mode and power supply rejections will be dependent only on the match between the two amplifiers (assuming perfect resistor matching).

The concepts of common-mode and power supply rejection ratio match ($\Delta CMRR$ and $\Delta PSRR$) are best demonstrated with a numerical example:

Assume $CMRR_A = +1\mu V/V$ or 120dB,
 and $CMRR_B = +0.75\mu V/V$ or 122.5dB,
 then $\Delta CMRR = 0.25\mu V/V$ or 132dB;
 if $CMRR_B = -0.75\mu V/V$ which is still 122.5dB,
 then $\Delta CMRR = 1.75\mu V/V$ or 115dB.

Clearly the LT1112/LT1114, by specifying and guaranteeing all of these matching parameters, can significantly improve the performance of matching-dependent circuits.

Typical performance of the instrumentation amplifier:

Input offset voltage = 35 μ V
 Offset voltage drift = 0.3 μ V/ $^{\circ}$ C
 Input bias current = 80pA

Input offset current = 100pA
 Input resistance = 800G Ω
 Input noise = 0.42 μ V_{P-P}

Three Op Amp Instrumentation Amplifier

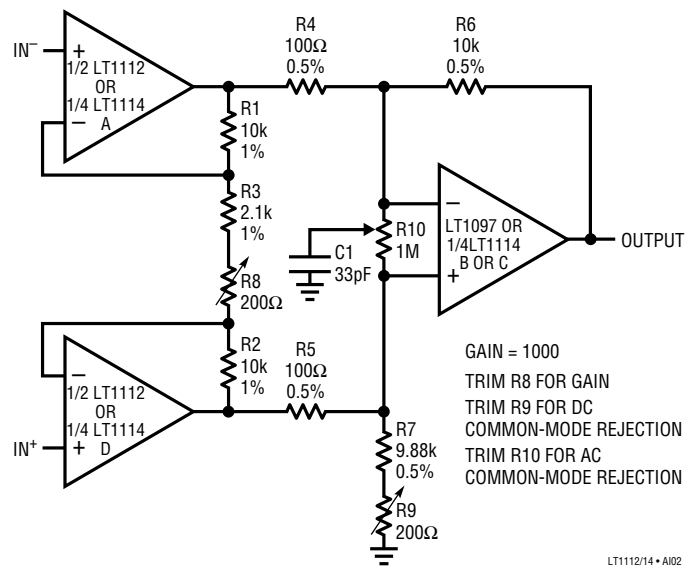

When the instrumentation amplifier is used with high impedance sources, the LT1114 is recommended because its CMRR vs frequency performance is better than the LT1112's. For example, with two matched 1M Ω source resistors, CMRR at 100Hz is 100dB with the LT1114, 76dB with the LT1112.

This difference is explained by the fact that capacitance between adjacent pins on an IC package is about 0.25pF (including package, socket and PC board trace capacitances).

On the dual op amp package, positive input A is next to the V^- pin (AC ground), while positive input B has no AC ground pin adjacent to it, resulting in a 0.25pF input capacitance mismatch. At 100Hz, 0.25pF represents a 6.4×10^9 input impedance mismatch, which is only 76dB higher than the 1M Ω source resistors.

On the quad package, all four inputs are adjacent to a power supply terminal—therefore, there is no mismatch.

TYPICAL APPLICATION

Dual Buffered $\pm 0.617V$ Reference Powered by Two AA Batteries

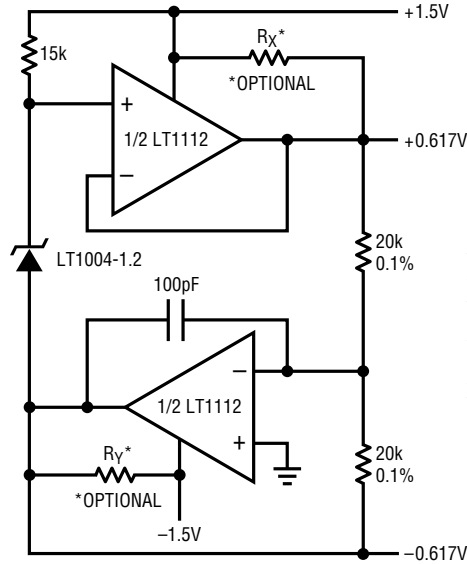

TOTAL SUPPLY CURRENT = $700\mu A$
 WORKS WITH BATTERIES DISCHARGED TO $\pm 1.3V$
 AT $\pm 1.5V$: MAXIMUM LOAD CURRENT = $800\mu A$;
 CAN BE INCREASED WITH OPTIONAL R_X, R_Y ;
 AT $R_X = R_Y = 750\Omega$ LOAD CURRENT = $2mA$
 TEMPERATURE COEFFICIENT LIMITED BY REFERENCE = $20ppm/^{\circ}C$

LT1112/14 • TA03

SCHEMATIC DIAGRAM (1/2 LT1112, 1/4 LT1114)

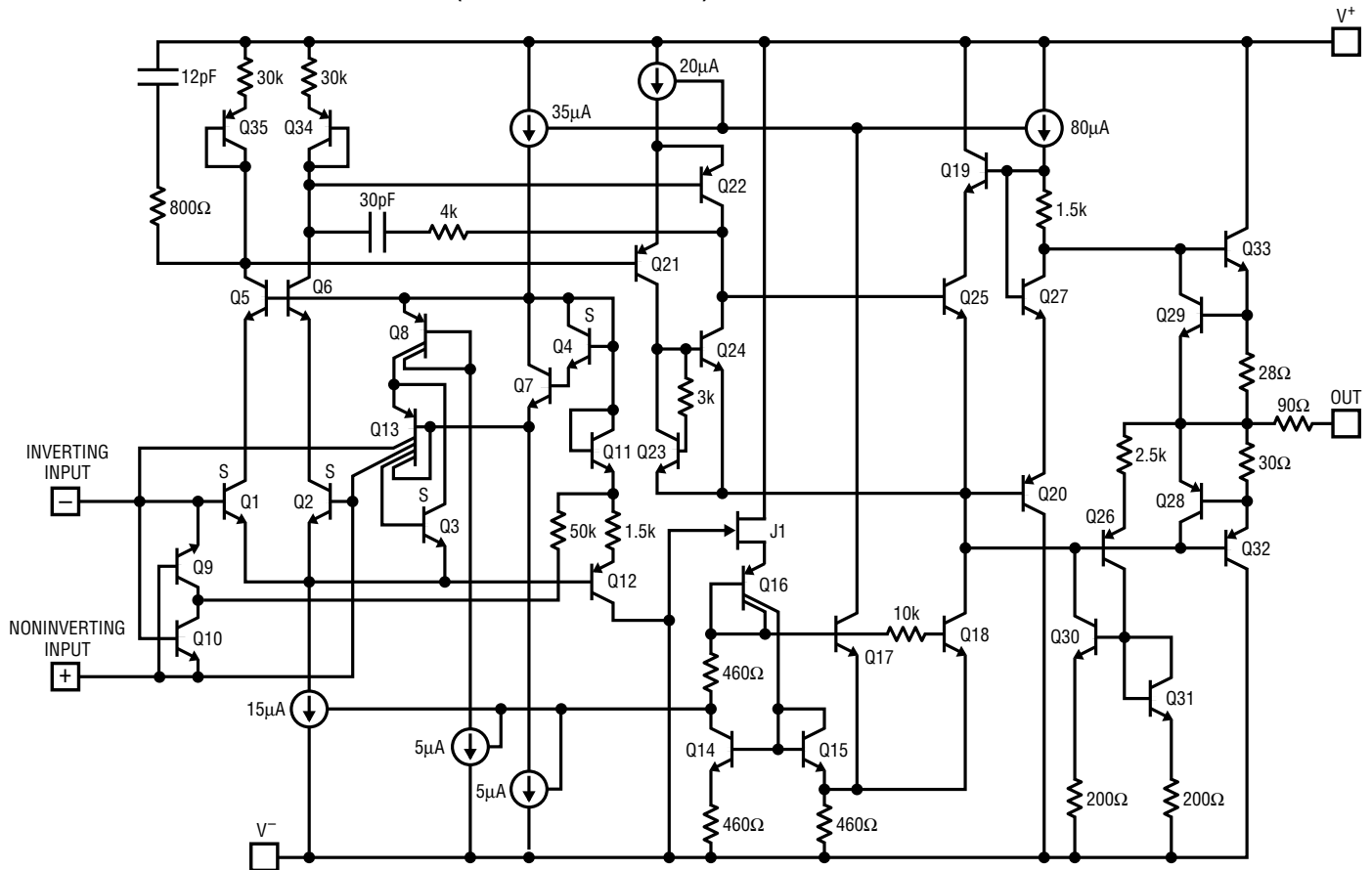

Q1 TO Q4 ARE SUPERGAIN TRANSISTORS

LT1112/14 • SD01

PACKAGE DESCRIPTION Dimensions in inches (millimeters) unless otherwise noted.

J8 Package
8-Lead Ceramic DIP

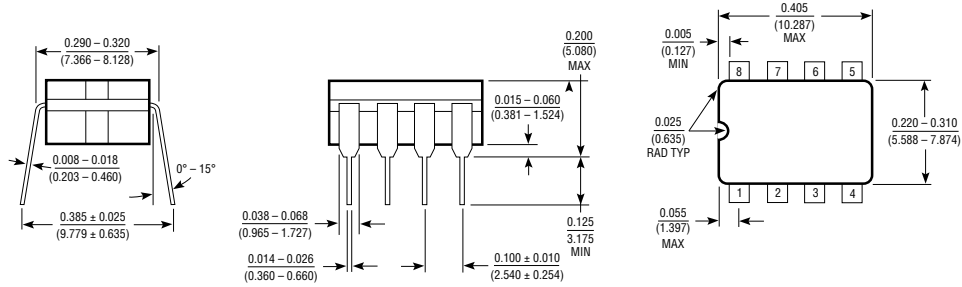

N8 Package
8-Lead Plastic DIP

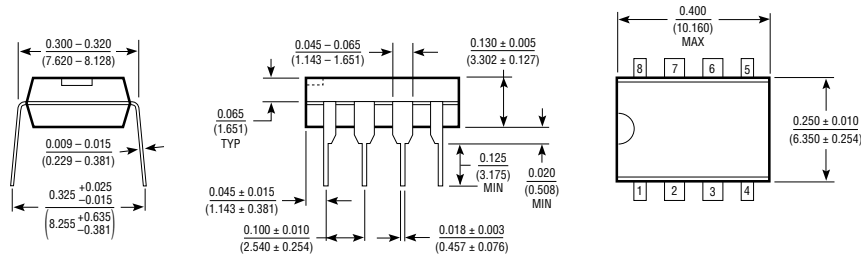

S8 Package
8-Lead Plastic SOIC

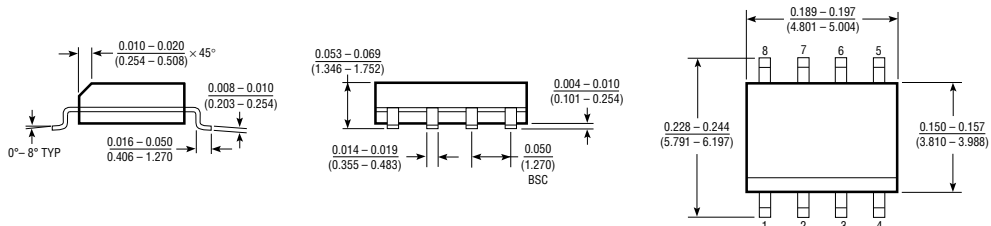

J Package
14-Lead Ceramic DIP

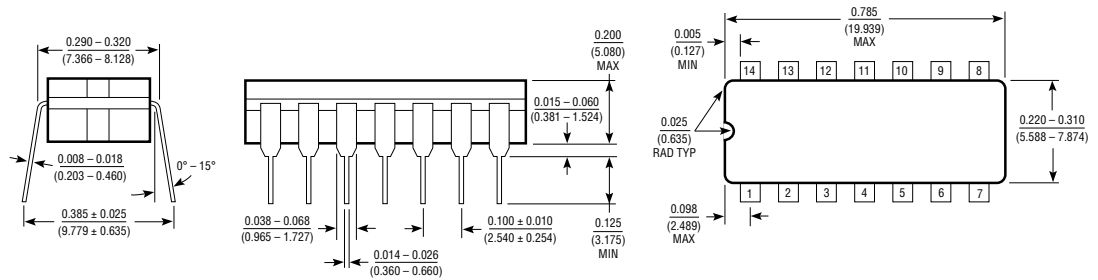

N Package
14-Lead Plastic DIP

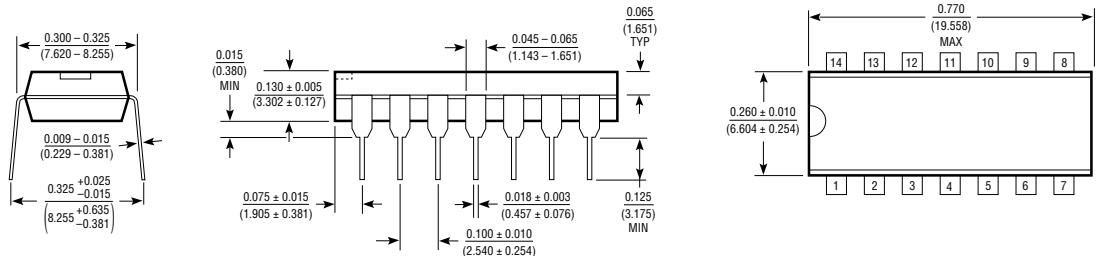

S Package
16-Lead Plastic SOIC

