



# 300MHz-to-450MHz Low-Power, Crystal-Based ASK Transmitter

MAX1472

## General Description

The MAX1472 is a crystal-referenced phase-locked loop (PLL) VHF/UHF transmitter designed to transmit OOK/ASK data in the 300MHz to 450MHz frequency range. The MAX1472 supports data rates up to 100kbps, and adjustable output power to more than +10dBm into a 50Ω load. The crystal-based architecture of the MAX1472 eliminates many of the common problems with SAW transmitters by providing greater modulation depth, faster frequency settling, higher tolerance of the transmit frequency, and reduced temperature dependence. Combined, these improvements enable better overall receiver performance when using a superheterodyne receiver such as the MAX1470 or MAX1473.

The MAX1472 is available in a 3mm x 3mm 8-pin SOT23 package and is specified for the automotive (-40°C to +125°C) temperature range. An evaluation kit is available. Contact Maxim Integrated Products for more information.

## Applications

- Remote Keyless Entry
- RF Remote Controls
- Tire Pressure Monitoring
- Security Systems
- Radio-Controlled Toys
- Wireless Game Consoles
- Wireless Computer Peripherals
- Wireless Sensors

## Typical Application Circuit

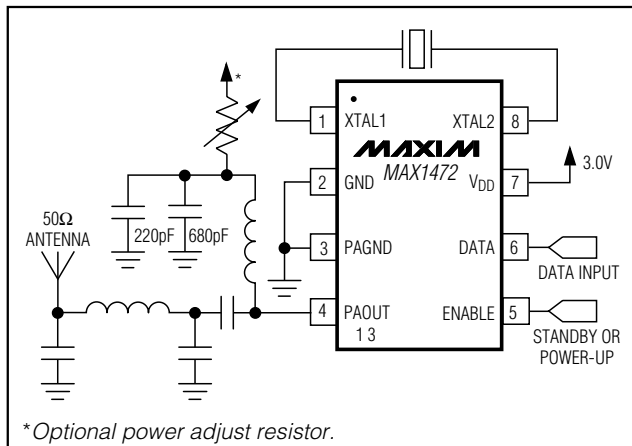

## Features

- ◆ 2.1V to 3.6V Single-Supply Operation
- ◆ Low 5.3mA Operating Supply Current\*
- ◆ Supports ASK with 90dB Modulation Depth
- ◆ Output Power Adjustable to More than +10dBm
- ◆ Uses Small Low-Cost Crystal
- ◆ Small 3mm x 3mm 8-Pin SOT23 Package
- ◆ Fast-On Oscillator 220μs Startup Time

\*At 50% duty cycle (315MHz, 2.7V supply, +10dBm output power)

## Ordering Information

PART	TEMP RANGE	PIN-PACKAGE	TOP MARK
MAX1472AKA-T	-40°C to +125°C	8 SOT23-8	AALM

## Pin Configuration

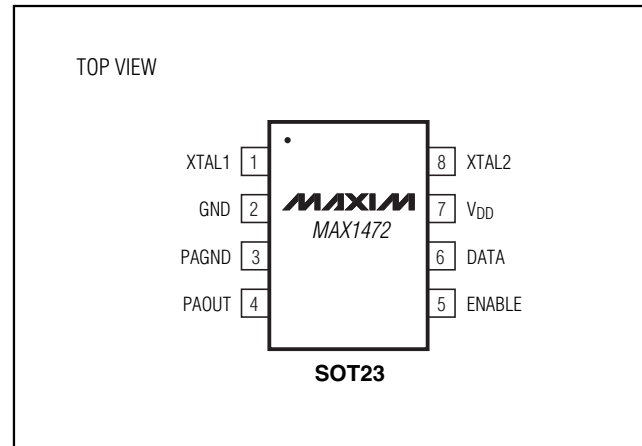

# 300MHz-to-450MHz Low-Power, Crystal-Based ASK Transmitter

## ABSOLUTE MAXIMUM RATINGS

V<sub>DD</sub> to GND .....-0.3V to +4.0V  
 All Other Pins to GND .....-0.3V to (V<sub>DD</sub> + 0.3V)  
 Continuous Power Dissipation (T<sub>A</sub> = +70°C)  
 8-Pin SOT23 (derate 8.9mW/°C above +70°C).....714mW

Operating Temperature Range .....-40°C to +125°C  
 Storage Temperature Range .....-60°C to +150°C  
 Lead Temperature (soldering, 10s) .....+300°C

Stresses beyond those listed under "Absolute Maximum Ratings" may cause permanent damage to the device. These are stress ratings only, and functional operation of the device at these or any other conditions beyond those indicated in the operational sections of the specifications is not implied. Exposure to absolute maximum rating conditions for extended periods may affect device reliability.

## ELECTRICAL CHARACTERISTICS

(Typical Application Circuit, output power is referenced to 50Ω, V<sub>DD</sub> = 2.1V to 3.6V, V<sub>ENABLE</sub> = V<sub>DD</sub>, T<sub>A</sub> = -40°C to +125°C, unless otherwise noted. Typical values are at V<sub>DD</sub> = 2.7V, T<sub>A</sub> = +25°C, unless otherwise noted.) (Note 1)

PARAMETER	SYMBOL	CONDITIONS	MIN	TYP	MAX	UNITS
<b>SYSTEM PERFORMANCE</b>						
Supply Voltage	V <sub>DD</sub>		2.1		3.6	V
Supply Current	I <sub>DD</sub>	f <sub>RF</sub> = 315MHz	V <sub>ENABLE</sub> = V <sub>DD</sub> (Note 2)	5.3	9.2	mA
			V <sub>ENABLE</sub> = V <sub>DD</sub> , V <sub>DATA</sub> = V <sub>DD</sub>	9.1	16.4	
			V <sub>ENABLE</sub> = V <sub>DD</sub> , V <sub>DATA</sub> = 0V	1.5	2.1	
		f <sub>RF</sub> = 433MHz	V <sub>ENABLE</sub> = V <sub>DD</sub> (Note 2)	5.7		
			V <sub>ENABLE</sub> = V <sub>DD</sub> , V <sub>DATA</sub> = V <sub>DD</sub>	9.6		
			V <sub>ENABLE</sub> = V <sub>DD</sub> , V <sub>DATA</sub> = 0V	1.7	2.5	
Standby Current	I <sub>STDBY</sub>	V <sub>ENABLE</sub> < V <sub>IL</sub> , T <sub>A</sub> < +85°C (Note 3)		5	350	nA
		V <sub>ENABLE</sub> < V <sub>IL</sub> , T <sub>A</sub> < +125°C (Note 3)			1.7	
Frequency Range	f <sub>RF</sub>	(Note 1)	300		450	MHz
Data Rate		(Note 3)	0		100	kbps
Modulation Depth		ON to OFF P <sub>OUT</sub> ratio (Note 4)		90		dB
Output Power	P <sub>OUT</sub>	T <sub>A</sub> = +25°C, V <sub>DD</sub> = 2.7V (Notes 8, 9)	7.3	10.3	12.8	dBm
		T <sub>A</sub> = +125°C, V <sub>DD</sub> = 2.1V (Notes 8, 9)	3.3	6.0		
		T <sub>A</sub> = -40°C, V <sub>DD</sub> = 3.6V (Notes 8, 9)		13.7	16.2	
Turn-On Time	t <sub>ON</sub>	To f <sub>OFFSET</sub> < 50kHz (Note 5)		220		μs
		To f <sub>OFFSET</sub> < 5kHz (Note 5)		450		
Transmit Efficiency with CW		f <sub>RF</sub> = 315MHz (Note 6)		43.6		%
		f <sub>RF</sub> = 433MHz (Note 6)		41.3		
Transmit Efficiency at 50% Duty Cycle		f <sub>RF</sub> = 315MHz (Note 7)		37.6		%
		f <sub>RF</sub> = 433MHz (Note 7)		35.1		

# 300MHz-to-450MHz Low-Power, Crystal-Based ASK Transmitter

MAX1472

## ELECTRICAL CHARACTERISTICS (continued)

(Typical Application Circuit, output power is referenced to 50Ω, V<sub>DD</sub> = 2.1V to 3.6V, V<sub>ENABLE</sub> = V<sub>DD</sub>, T<sub>A</sub> = -40°C to +125°C, unless otherwise noted. Typical values are at V<sub>DD</sub> = 2.7V, T<sub>A</sub> = +25°C, unless otherwise noted.) (Note 1)

PARAMETER	SYMBOL	CONDITIONS	MIN	TYP	MAX	UNITS
<b>PHASE-LOCKED LOOP PERFORMANCE</b>						
VCO Gain				330		MHz/V
Phase Noise		f <sub>RF</sub> = 315MHz	f <sub>OFFSET</sub> = 100kHz	-84		dBc/Hz
			f <sub>OFFSET</sub> = 1MHz	-91		
		f <sub>RF</sub> = 433MHz	f <sub>OFFSET</sub> = 100kHz	-82		
			f <sub>OFFSET</sub> = 1MHz	-89		
Maximum Carrier Harmonics		f <sub>RF</sub> = 315MHz		-50		dBc
		f <sub>RF</sub> = 433MHz		-50		
Reference Spur		f <sub>RF</sub> = 315MHz		-75		dBc
		f <sub>RF</sub> = 433MHz		-81		
Loop Bandwidth				1.6		MHz
Crystal Frequency	f <sub>XTAL</sub>			f <sub>RF</sub> / 32		MHz
Oscillator Input Impedance		From each XTAL pin to GND		6.2		pF
Frequency Pushing by V <sub>DD</sub>				3		ppm/V
Maximum Crystal Inductance				50		nH
<b>DIGITAL INPUTS</b>						
Data Input High	V <sub>IH</sub>		V <sub>DD</sub> - 0.25			V
Data Input Low	V <sub>IL</sub>				0.25	V
Maximum Input Current				2		nA
Pulldown Current				25		μA

**Note 1:** 100% tested at T<sub>A</sub> = +25°C. Guaranteed by design and characterization over temperature.

**Note 2:** 50% duty cycle at 10kHz data.

**Note 3:** Guaranteed by design and characterization, not production tested.

**Note 4:** Generally limited by PC board layout.

**Note 5:** V<sub>ENABLE</sub> < V<sub>IL</sub> to V<sub>ENABLE</sub> > V<sub>IH</sub>. f<sub>OFFSET</sub> is defined as the frequency deviation from the desired carrier frequency.

**Note 6:** V<sub>ENABLE</sub> > V<sub>IH</sub>, V<sub>DATA</sub> > V<sub>IH</sub>, Efficiency = P<sub>OUT</sub> / (V<sub>DD</sub> × I<sub>DD</sub>).

**Note 7:** V<sub>ENABLE</sub> > V<sub>IH</sub>, DATA toggled from V<sub>IL</sub> to V<sub>IH</sub>, 10kHz, 50% duty cycle, Efficiency = P<sub>OUT</sub> / (V<sub>DD</sub> × I<sub>DD</sub>).

**Note 8:** Output power can be adjusted with external resistor.

**Note 9:** Guaranteed by design and characterization at f<sub>RF</sub> = 315MHz.

# 300MHz-to-450MHz Low-Power, Crystal-Based ASK Transmitter

## Typical Operating Characteristics

(Typical Application Circuit,  $V_{DD} = 2.7V$ ,  $T_A = +25^\circ C$ , unless otherwise noted.)

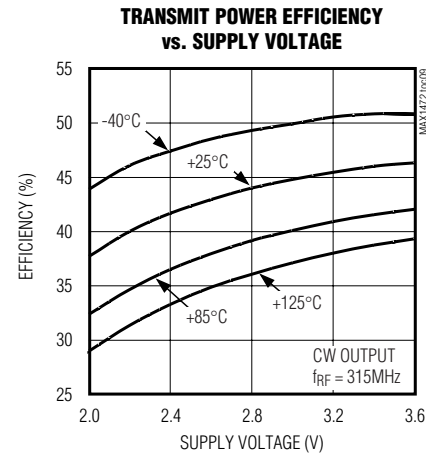
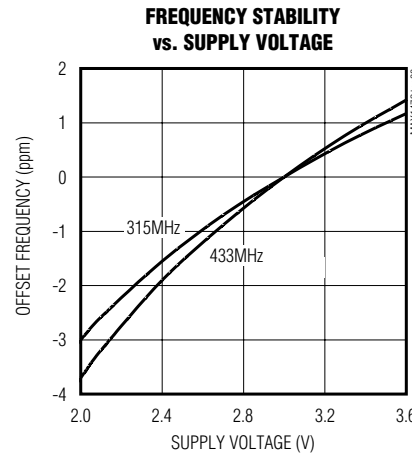
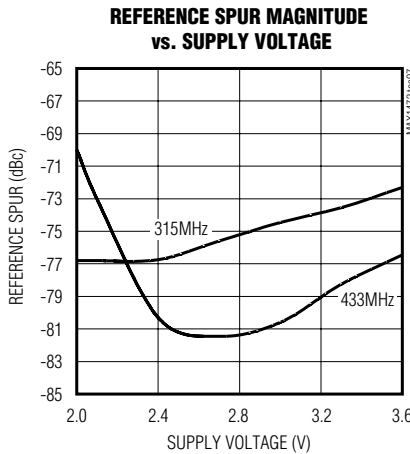
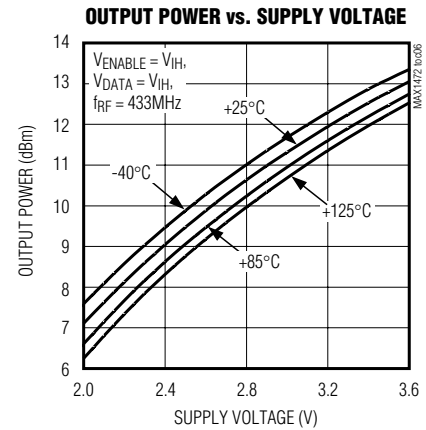
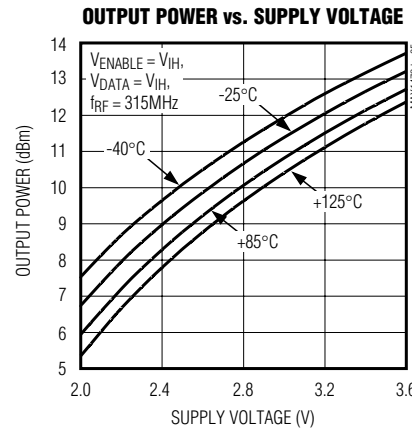
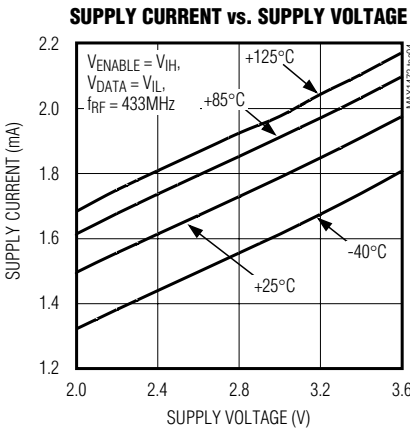
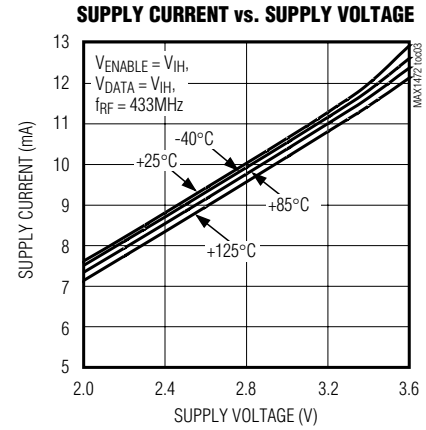
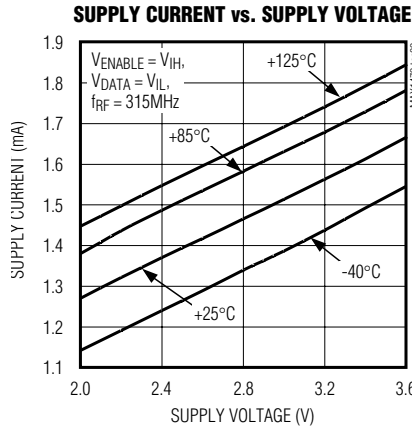
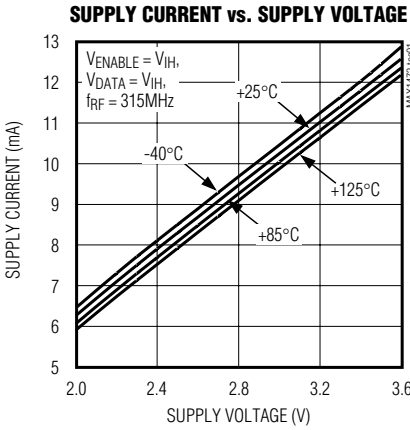

# 300MHz-to-450MHz Low-Power, Crystal-Based ASK Transmitter

MAX1472

## Typical Operating Characteristics (continued)

(Typical Application Circuit,  $V_{DD} = 2.7V$ ,  $T_A = +25^\circ C$ , unless otherwise noted.)

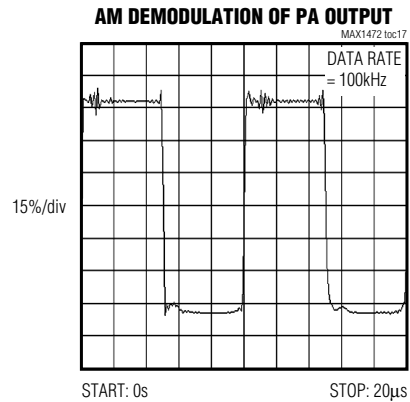
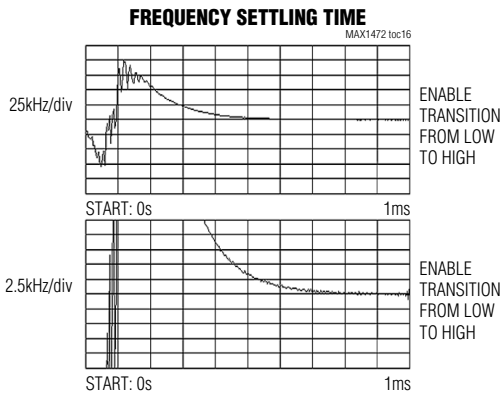
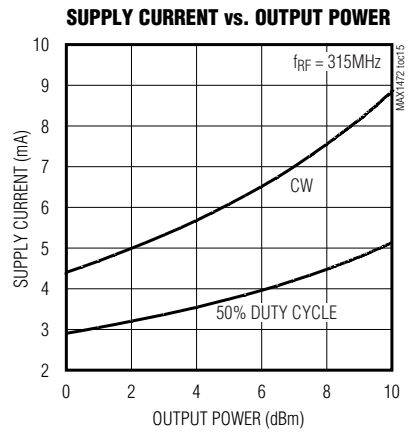
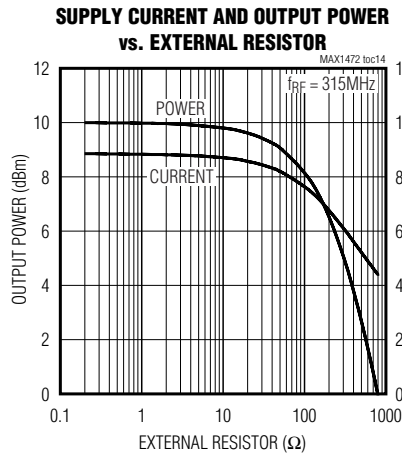
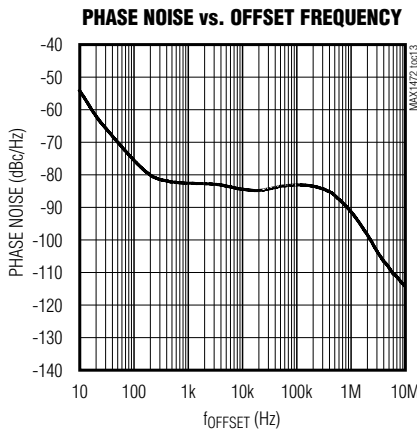
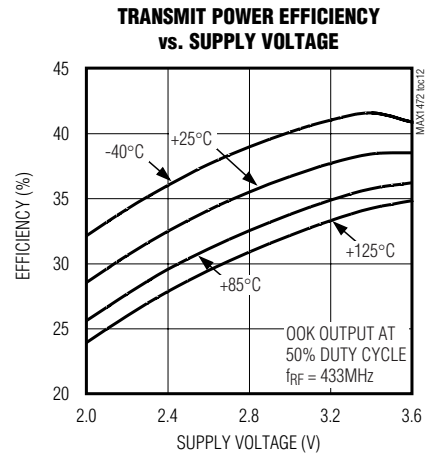
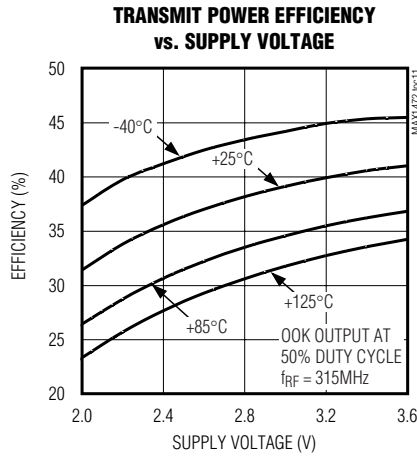
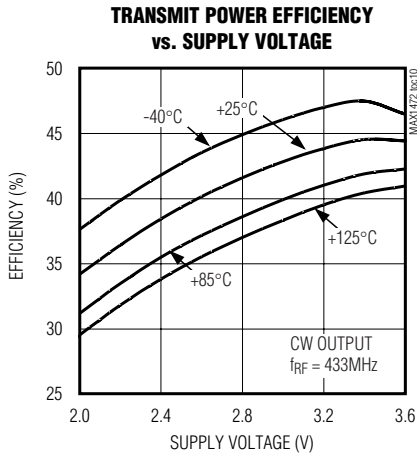

# 300MHz-to-450MHz Low-Power, Crystal-Based ASK Transmitter

## Pin Description

PIN	NAME	FUNCTION
1	XTAL1	1st Crystal Input. $f_{RF} = 32 \times f_{XTAL}$ .
2	GND	Ground. Connect to system ground.
3	PAGND	Ground for the Power Amplifier (PA). Connect to system ground.
4	PAOUT	Power-Amplifier Output. This output requires a pullup inductor to the supply voltage, which may be part of the output-matching network to a 50Ω antenna.
5	ENABLE	Standby/Power-Up Input. A logic low on ENABLE places the device in standby mode.
6	DATA	OOK Data Input. Power amplifier is ON when DATA is high.
7	V <sub>DD</sub>	Supply Voltage. Bypass to GND with capacitor as close to the pin as possible.
8	XTAL2	2nd Crystal Input. $f_{RF} = 32 \times f_{XTAL}$ .

## Detailed Description

The MAX1472 is a highly integrated OOK/ASK transmitter operating over the 300MHz to 450MHz frequency range. The IC includes a complete PLL and a highly efficient PA. The device can also be easily placed into a 5nA low-power shutdown mode.

### Shutdown Mode

The ENABLE pin is internally pulled down with a 15μA current source. If the pin is left floating or pulled low, the MAX1472 goes into shutdown mode, where the supply current drops to less than 5nA. When ENABLE is high, the IC is enabled and is ready for transmission after 220μs (frequency settles to within 50kHz).

The 220μs turn-on time of the MAX1472 is mostly dominated by the crystal oscillator startup time. Once the oscillator is running, the 1.6MHz PLL loop bandwidth allows fast-frequency recovery during power-amplifier toggling.

### Phase-Locked Loop

The PLL block contains a phase detector, charge pump, integrated loop filter, VCO, 32X clock divider, and crystal oscillator. This PLL requires no external components, other than a crystal. The relationship between the carrier and crystal frequency is given by:

$$f_{XTAL} = f_{RF} / 32$$

The lock-detect circuit prevents the PA from transmitting until the PLL is locked. In addition, the device shuts down the PA if the reference frequency is lost.

## Power Amplifier

The PA of the MAX1472 is a high-efficiency, open-drain, class-C amplifier. With proper output matching network, the PA can drive a wide range of impedances, including the small-loop PC board trace antenna and any 50Ω antenna. The output-matching network for a 50Ω antenna is shown in the *Typical Application Circuit*. The output-matching network suppresses the carrier harmonics and transforms the antenna impedance to an optimal impedance at PAOUT (pin 4), which is about 250Ω.

When the output matching network is properly tuned, the PA transmits power with high efficiency. The *Typical Application Circuit* delivers 10.3dBm at 2.7V supply with 9.1mA of supply current. Thus, the overall efficiency is 44%. The efficiency of the PA itself is more than 52%.

## Applications Information

### Output Power Adjustment

It is possible to adjust the output power down to -10dBm with the addition of a resistor. The addition of the power-adjust resistor also reduces power consumption. See the Supply Current and Output Power vs. External Resistor and Supply Current vs. Output Power graphs in the *Typical Operating Characteristics* section. It is imperative to add both a low-frequency and a high-frequency decoupling capacitor as shown in the *Typical Application Circuit*.

# 300MHz-to-450MHz Low-Power, Crystal-Based ASK Transmitter

MAX1472

## Crystal Oscillator

The crystal oscillator in the MAX1472 is designed to present a capacitance of approximately 3.1pF between the XTAL1 and XTAL2 pins. If a crystal designed to oscillate with a different load capacitance is used, the crystal is pulled away from its intended operating frequency, thus introducing an error in the reference frequency. Crystals designed to operate with higher differential load capacitance always pull the reference frequency higher. For example, a 9.84375MHz crystal designed to operate with a 10pF load capacitance oscillates at 9.84688MHz with the MAX1472, causing the transmitter to be transmitting at 315.1MHz rather than 315.0MHz, an error of about 100kHz, or 320ppm.

In actuality, the oscillator pulls every crystal. The crystal's natural frequency is really below its specified frequency, but when loaded with the specified load capacitance, the crystal is pulled and oscillates at its specified frequency. This pulling is already accounted for in the specification of the load capacitance. Additional pulling can be calculated if the electrical parameters of the crystal are known. The frequency pulling is given by:

$$f_p = \frac{C_m}{2} \left( \frac{1}{C_{\text{case}} + C_{\text{load}}} - \frac{1}{C_{\text{case}} + C_{\text{spec}}} \right) \times 10^6$$

where:

$f_p$  is the amount the crystal frequency is pulled in ppm.

$C_m$  is the motional capacitance of the crystal.

$C_{\text{case}}$  is the case capacitance.

$C_{\text{spec}}$  is the specified load capacitance.

$C_{\text{load}}$  is the actual load capacitance.

When the crystal is loaded as specified, i.e.,  $C_{\text{load}} = C_{\text{spec}}$ , the frequency pulling equals zero.

## Output Matching to 50Ω

When matched to a 50Ω system, the MAX1472 PA is capable of delivering more than +10dBm of output power at  $V_{DD} = 2.7V$ . The output of the PA is an open-drain transistor that requires external impedance matching and pullup inductance for proper biasing. The pullup inductance from PA to  $V_{DD}$  serves three main purposes: It resonates the capacitance of the PA output, provides biasing for the PA, and becomes a high-frequency choke to reduce the RF energy coupling into  $V_{DD}$ . The recommended output-matching network topology is shown in the *Typical Application Circuit*. The matching network transforms the 50Ω load to a higher impedance at the output of the PA in addition to forming a bandpass filter that provides attenuation for the higher order harmonics.

## Output Matching to PC Board Loop Antenna

In most applications, the MAX1472 PA output has to be impedance matched to a small-loop antenna. The antenna is usually fabricated out of a copper trace on a PC board in a rectangular, circular, or square pattern. The antenna has an impedance that consists of a lossy component and a radiative component. To achieve high radiating efficiency, the radiative component should be as high as possible, while minimizing the lossy component. In addition, the loop antenna has an inherent loop inductance associated with it (assuming the antenna is terminated to ground). For example, in a typical application, the radiative impedance is less than 0.5Ω, the lossy impedance is less than 0.7Ω, and the inductance is approximately 50nH to 100nH.

The objective of the matching network is to match the PA output to the small loop antenna. The matching components thus transform the low radiative and resistive parts of the antenna into the much higher value of the PA output, which gives higher efficiency. The low radiative and lossy components of the small loop antenna result in a higher Q matching network than the 50Ω network; thus, the harmonics are lower.

## 300MHz-to-450MHz Low-Power, Crystal-Based ASK Transmitter

### Layout Considerations

A properly designed PC board is an essential part of any RF/microwave circuit. On the PA output, use controlled-impedance lines and keep them as short as possible to minimize losses and radiation. At high frequencies, trace lengths that are on the order of  $\lambda/10$  or longer can act as antennas.

Keeping the traces short also reduces parasitic inductance. Generally, 1in of PC board trace adds about 20nH of parasitic inductance. The parasitic inductance can have a dramatic effect on the effective inductance. For example, a 0.5in trace connecting a 100nH inductor adds an extra 10nH of inductance, or 10%.

To reduce the parasitic inductance, use wider traces and a solid ground or power plane below the signal traces. Using a solid ground plane can reduce the parasitic inductance from approximately 20nH/in to 7nH/in. Also, use low-inductance connections to ground on all GND pins, and place decoupling capacitors close to all VDD connections.

### Functional Diagram

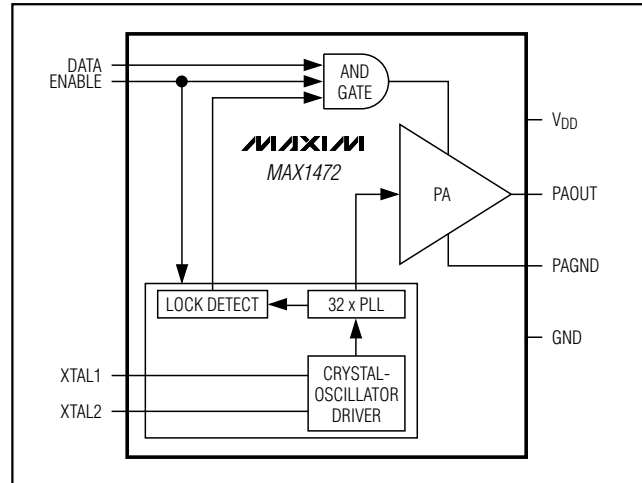

### Chip Information

TRANSISTOR COUNT: 1430

PROCESS: CMOS



# 300MHz-to-450MHz Low-Power, Crystal-Based ASK Transmitter

## Package Information

(The package drawing(s) in this data sheet may not reflect the most current specifications. For the latest package outline information go to [www.maxim-ic.com/packages](http://www.maxim-ic.com/packages).)

MAX1472

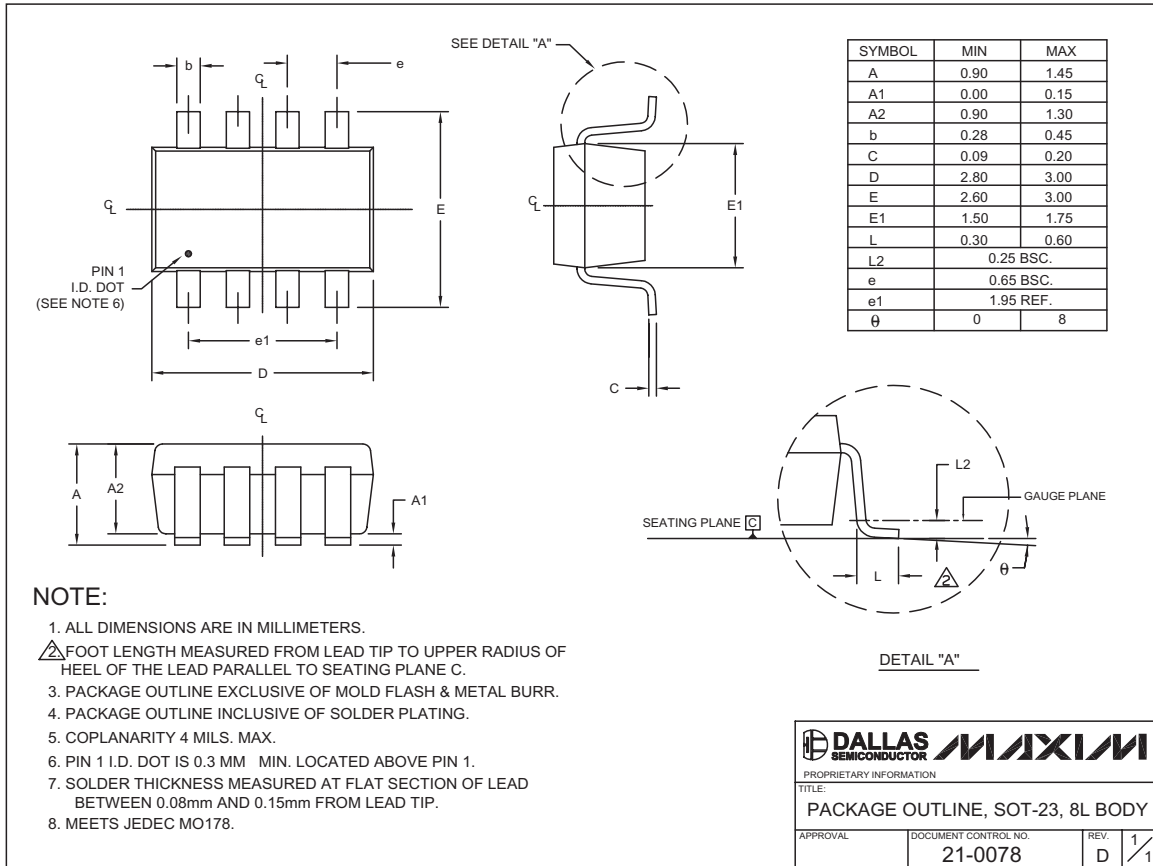

SOT23, 8L, EPS

Maxim cannot assume responsibility for use of any circuitry other than circuitry entirely embodied in a Maxim product. No circuit patent licenses are implied. Maxim reserves the right to change the circuitry and specifications without notice at any time.

Maxim Integrated Products, 120 San Gabriel Drive, Sunnyvale, CA 94086 408-737-7600 9