

MBRAF260T3G, NRVBAF260T3G

Surface Mount Schottky Power Rectifier

This device employs the Schottky Barrier principle in a large area metal-to-silicon power diode. State-of-the-art geometry features epitaxial construction with oxide passivation and metal overlay contact. Ideally suited for low voltage, high frequency rectification, or as free wheeling and polarity protection diodes in surface mount applications where compact size and weight are critical to the system.

Features

- Low Profile Package for Space Constrained Applications
- Rectangular Package for Automated Handling
- Highly Stable Oxide Passivated Junction
- 150°C Operating Junction Temperature
- Guard-Ring for Stress Protection
- NRVB Prefix for Automotive and Other Applications Requiring Unique Site and Control Change Requirements; AEC-Q101 Qualified and PPAP Capable
- These are Pb-Free and Halide-Free Devices

Mechanical Characteristics

- Case: Epoxy, Molded, Epoxy Meets UL 94, V-0
- Weight: 95 mg (approximately)
- Finish: All External Surfaces Corrosion Resistant and Terminal Leads are Readily Solderable
- Lead and Mounting Surface Temperature for Soldering Purposes: 260°C Max. for 10 Seconds
- Cathode Polarity Band
- Device Meets MSL 1 Requirements
- ESD Ratings: Machine Model = C
Human Body Model = 3B



ON Semiconductor®

<http://onsemi.com>

**SCHOTTKY BARRIER
RECTIFIER
2.0 AMPERE
60 VOLTS**

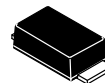

**SMA-FL
CASE 403AA
STYLE 6**

MARKING DIAGRAM



RAG = Specific Device Code
A = Assembly Location
Y = Year
WW = Work Week
▪ = Pb-Free Package
(Note: Microdot may be in either location)

ORDERING INFORMATION

| Device | Package | Shipping† |
|--------------|---------------------|--------------------|
| MBRAF260T3G | SMA-FL (Pb-Free) | 5000 / Tape & Reel |
| NRVBAF260T3G | SMA-FL (Pb-Free) | 5000 / Tape & Reel |

†For information on tape and reel specifications, including part orientation and tape sizes, please refer to our Tape and Reel Packaging Specification Brochure, BRD8011/D.

MBRAF260T3G, NRVBAF260T3G

MAXIMUM RATINGS

| Rating | Symbol | Value | Unit |
|---|---------------------------------|-------------|------------------|
| Peak Repetitive Reverse Voltage Working Peak Reverse Voltage DC Blocking Voltage | V_{RRM} V_{RWM} V_R | 60 | V |
| Average Rectified Forward Current (At Rated V_R , $T_L = 120^\circ\text{C}$) | I_O | 2.0 | A |
| Peak Repetitive Forward Current (Rated V_R , Square Wave, 20 kHz) $T_L = 90^\circ\text{C}$ | I_{FRM} | 4.0 | A |
| Non-Repetitive Peak Surge Current (Surge Applied at Rated Load Conditions Halfwave, Single Phase, 60 Hz) | I_{FSM} | 60 | A |
| Storage Temperature Range | T_{stg} | -55 to +150 | $^\circ\text{C}$ |
| Operating Junction Temperature | T_J | -55 to +150 | $^\circ\text{C}$ |
| Voltage Rate of Change (Rated V_R , $T_J = 25^\circ\text{C}$) | dv/dt | 10,000 | V/ μs |

Stresses exceeding those listed in the Maximum Ratings table may damage the device. If any of these limits are exceeded, device functionality should not be assumed, damage may occur and reliability may be affected.

THERMAL CHARACTERISTICS

| Characteristic | Symbol | Value | Unit |
|--|-----------------|-------|---------------------------|
| Thermal Resistance, Junction-to-Lead (Note 1) | $R_{\theta JL}$ | 25 | $^\circ\text{C}/\text{W}$ |
| Thermal Resistance, Junction-to-Ambient (Note 1) | $R_{\theta JA}$ | 90 | |

1. 1 inch square pad size (1 x 0.5 inch for each lead) on FR4 board.

ELECTRICAL CHARACTERISTICS

| Characteristic | Symbol | Value | | Unit |
|--|--------|--------------------------|---------------------------|------|
| | | $T_J = 25^\circ\text{C}$ | $T_J = 125^\circ\text{C}$ | |
| Maximum Instantaneous Forward Voltage (Note 2) ($i_F = 1.0\text{ A}$) ($i_F = 2.0\text{ A}$) | V_F | 0.51 | 0.475 | V |
| | | 0.63 | 0.55 | |
| Maximum Instantaneous Reverse Current (Note 2) ($V_R = 60\text{ V}$) | I_R | 0.2 | 20 | mA |
| | | | | |

Product parametric performance is indicated in the Electrical Characteristics for the listed test conditions, unless otherwise noted. Product performance may not be indicated by the Electrical Characteristics if operated under different conditions.

2. Pulse Test: Pulse Width $\leq 250\ \mu\text{s}$, Duty Cycle $\leq 2.0\%$.

MBRAF260T3G, NRVBAF260T3G

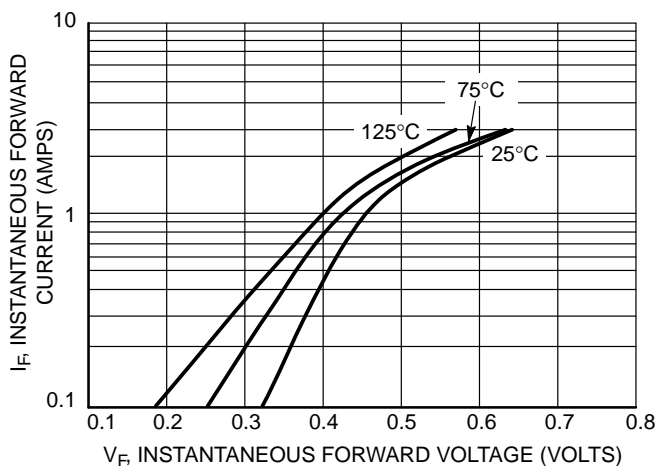

Figure 1. Typical Forward Voltage

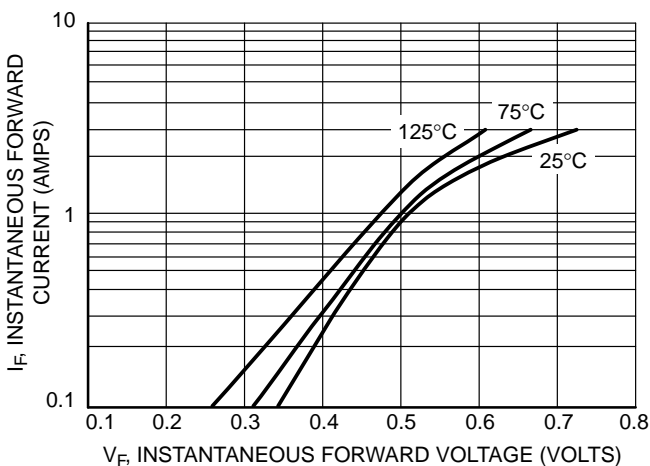

Figure 2. Maximum Forward Voltage

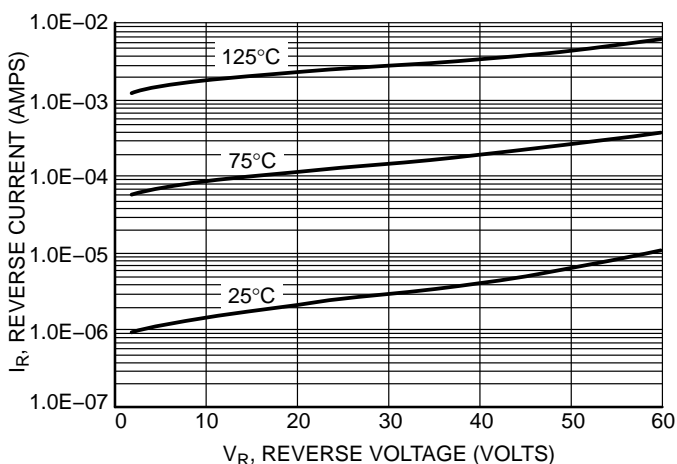

Figure 3. Typical Reverse Current

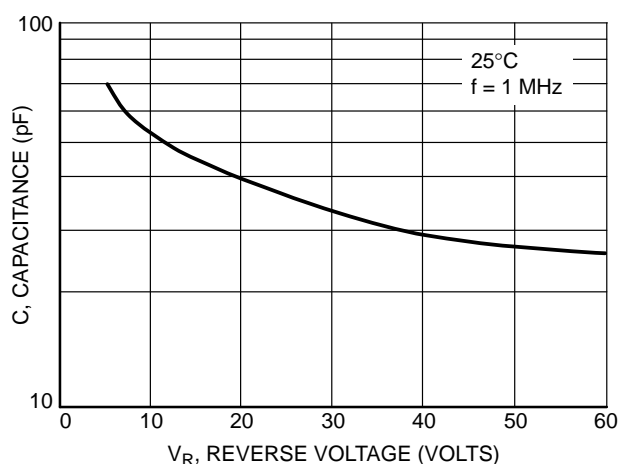

Figure 4. Typical Capacitance

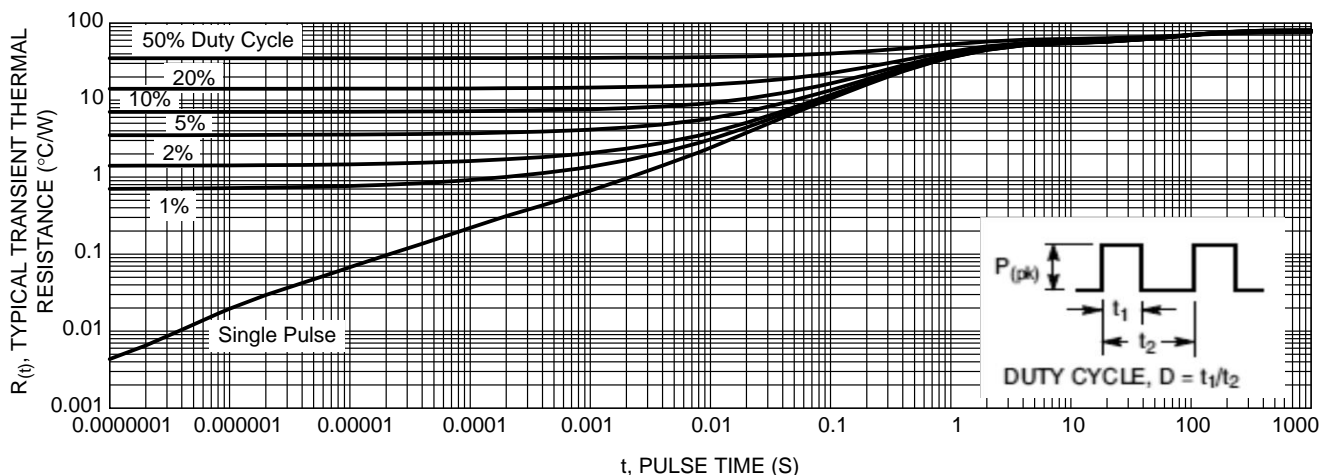
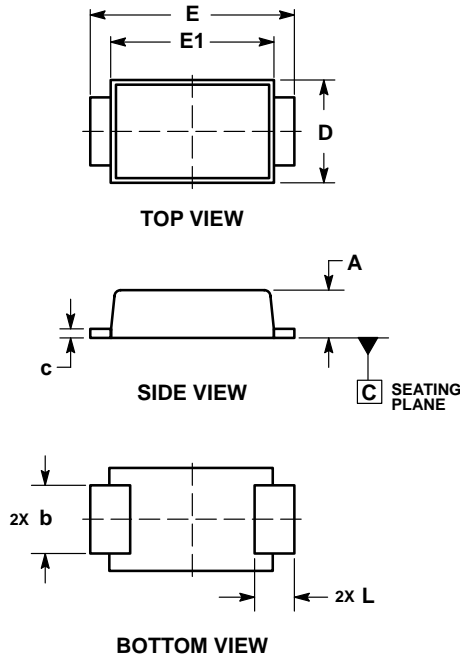

Figure 5. Typical Transient Thermal Response, Junction-to-Ambient

MBRAF260T3G, NRVBAF260T3G

PACKAGE DIMENSIONS

SMA-FL
CASE 403AA
ISSUE O



- NOTES:
1. DIMENSIONING AND TOLERANCING PER ASME Y14.5M, 1994.
 2. CONTROLLING DIMENSION: MILLIMETERS.

| MILLIMETERS | | |
|-------------|------|------|
| DIM | MIN | MAX |
| A | 0.90 | 1.10 |
| b | 1.25 | 1.65 |
| c | 0.15 | 0.30 |
| D | 2.40 | 2.80 |
| E | 4.80 | 5.40 |
| E1 | 4.00 | 4.60 |
| L | 0.70 | 1.10 |

RECOMMENDED SOLDER FOOTPRINT*

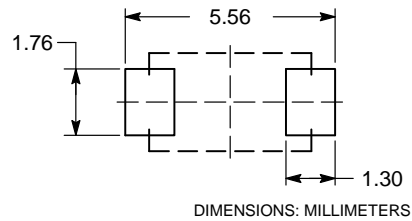

*For additional information on our Pb-Free strategy and soldering details, please download the ON Semiconductor Soldering and Mounting Techniques Reference Manual, SOLDERRM/D.

ON Semiconductor and  are registered trademarks of Semiconductor Components Industries, LLC (SCILLC). SCILLC owns the rights to a number of patents, trademarks, copyrights, trade secrets, and other intellectual property. A listing of SCILLC's product/patent coverage may be accessed at www.onsemi.com/site/pdf/Patent-Marking.pdf. SCILLC reserves the right to make changes without further notice to any products herein. SCILLC makes no warranty, representation or guarantee regarding the suitability of its products for any particular purpose, nor does SCILLC assume any liability arising out of the application or use of any product or circuit, and specifically disclaims any and all liability, including without limitation special, consequential or incidental damages. "Typical" parameters which may be provided in SCILLC data sheets and/or specifications can and do vary in different applications and actual performance may vary over time. All operating parameters, including "Typicals" must be validated for each customer application by customer's technical experts. SCILLC does not convey any license under its patent rights nor the rights of others. SCILLC products are not designed, intended, or authorized for use as components in systems intended for surgical implant into the body, or other applications intended to support or sustain life, or for any other application in which the failure of the SCILLC product could create a situation where personal injury or death may occur. Should Buyer purchase or use SCILLC products for any such unintended or unauthorized application, Buyer shall indemnify and hold SCILLC and its officers, employees, subsidiaries, affiliates, and distributors harmless against all claims, costs, damages, and expenses, and reasonable attorney fees arising out of, directly or indirectly, any claim of personal injury or death associated with such unintended or unauthorized use, even if such claim alleges that SCILLC was negligent regarding the design or manufacture of the part. SCILLC is an Equal Opportunity/Affirmative Action Employer. This literature is subject to all applicable copyright laws and is not for resale in any manner.

PUBLICATION ORDERING INFORMATION

LITERATURE FULFILLMENT:
Literature Distribution Center for ON Semiconductor
P.O. Box 5163, Denver, Colorado 80217 USA
Phone: 303-675-2175 or 800-344-3860 Toll Free USA/Canada
Fax: 303-675-2176 or 800-344-3867 Toll Free USA/Canada
Email: orderlit@onsemi.com

N. American Technical Support: 800-282-9855 Toll Free
USA/Canada
Europe, Middle East and Africa Technical Support:
Phone: 421 33 790 2910
Japan Customer Focus Center
Phone: 81-3-5817-1050

ON Semiconductor Website: www.onsemi.com
Order Literature: <http://www.onsemi.com/orderlit>
For additional information, please contact your local Sales Representative