

Complementary Power Transistors

For Isolated Package Applications

Designed for general-purpose amplifier and switching applications, where the mounting surface of the device is required to be electrically isolated from the heatsink or chassis.

- Electrically Similar to the Popular MJE15030 and MJE15031
- 150 V_{CEO(sus)}
- 8 A Rated Collector Current
- No Isolating Washers Required
- Reduced System Cost
- High Current Gain-Bandwidth Product
f_T = 30 MHz (Min) @ I_C = 500 mAdc
- UL Recognized, File #E69369, to 3500 V_{RMS} Isolation

NPN
MJF15030
PNP
MJF15031

COMPLEMENTARY
SILICON
POWER TRANSISTORS
8 AMPERES
150 VOLTS
36 WATTS

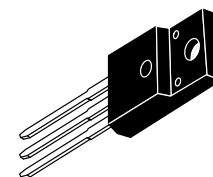

CASE 221D-02
TO-220 TYPE

MAXIMUM RATINGS

Rating	Symbol	Value	Unit
Collector-Emitter Voltage	V _{CEO}	150	Vdc
Collector-Base Voltage	V _{CB}	150	Vdc
Emitter-Base Voltage	V _{EB}	5	Vdc
RMS Isolation Voltage (1) (for 1 sec, R.H. < 30%, T _A = 25°C)	V _{ISOL}	4500 3500 1500	V _{RMS}
Collector Current — Continuous — Peak	I _C	8 16	Adc
Base Current	I _B	2	Adc
Total Power Dissipation* @ T _C = 25°C Derate above 25°C	P _D	36 0.29	Watts W/°C
Total Power Dissipation @ T _A = 25°C Derate above 25°C	P _D	2 0.016	Watts W/°C
Operating and Storage Junction Temperature Range	T _J , T _{stg}	-65 to +150	°C

THERMAL CHARACTERISTICS

Characteristic	Symbol	Max	Unit
Thermal Resistance, Junction to Ambient	R _{θJA}	62.5	°C/W
Thermal Resistance, Junction to Case*	R _{θJC}	3.5	°C/W
Lead Temperature for Soldering Purpose	T _L	260	°C

* Measurement made with thermocouple contacting the bottom insulated mounting surface (in a location beneath the die), the device mounted on a heatsink with thermal grease and a mounting torque of ≥ 6 in. lbs.

(1) Proper strike and creepage distance must be provided.

MJF15030 MJF15031

ELECTRICAL CHARACTERISTICS (T_C = 25°C unless otherwise noted)

Characteristic	Symbol	Min	Max	Unit
OFF CHARACTERISTICS				
Collector–Emitter Sustaining Voltage (1) (I _C = 10 mA _{dc} , I _B = 0)	V _{CEO(sus)}	150	—	V _{dc}
Collector Cutoff Current (V _{CE} = 150 V _{dc} , I _B = 0)	I _{CEO}	—	10	μA _{dc}
Collector Cutoff Current (V _{CB} = 150 V _{dc} , I _E = 0)	I _{CBO}	—	10	μA _{dc}
Emitter Cutoff Current (V _{BE} = 5 V _{dc} , I _C = 0)	I _{EBO}	—	10	μA _{dc}
ON CHARACTERISTICS (1)				
DC Current Gain (I _C = 0.1 A _{dc} , V _{CE} = 2 V _{dc}) (I _C = 2 A _{dc} , V _{CE} = 2 V _{dc}) (I _C = 3 A _{dc} , V _{CE} = 2 V _{dc}) (I _C = 4 A _{dc} , V _{CE} = 2 V _{dc})	h _{FE}	40 40 40 20	— — — —	—
DC Current Gain Linearity (V _{CE} from 2 V to 20 V, I _C from 0.1 A to 3 A) (NPN to PNP)	h _{FE}	Typ 2 3		
Collector–Emitter Saturation Voltage (I _C = 1 A _{dc} , I _B = 0.1 A _{dc})	V _{CE(sat)}	—	0.5	V _{dc}
Base–Emitter On Voltage (I _C = 1 A _{dc} , V _{CE} = 2 V _{dc})	V _{BE(on)}	—	1	V _{dc}
DYNAMIC CHARACTERISTICS				
Current Gain–Bandwidth Product (2) (I _C = 500 mA _{dc} , V _{CE} = 10 V _{dc} , f _{test} = 10 MHz)	f _T	30	—	MHz

NOTES:

1. Pulse Test: Pulse Width ≤ 300 μs, Duty Cycle ≤ 2%.
2. f_T = |h_{fe}| • f_{test}.

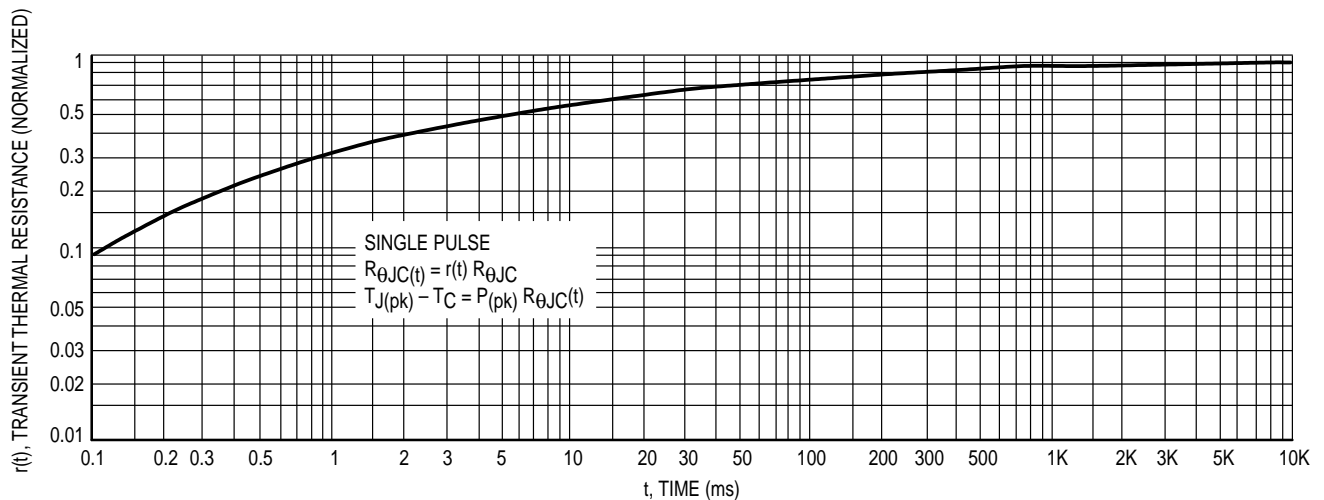

Figure 1. Thermal Response

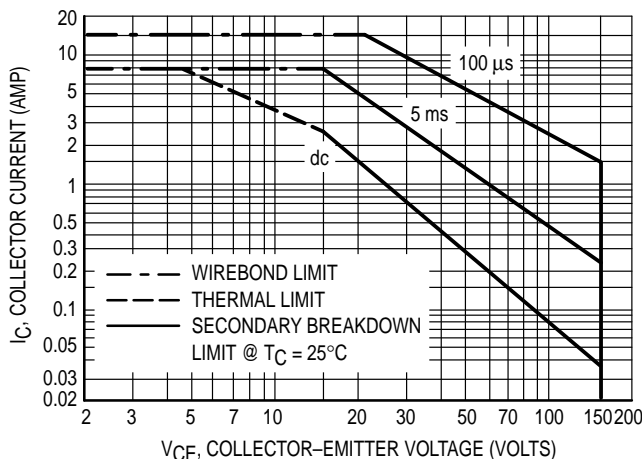

Figure 2. Forward Bias Safe Operating Area

There are two limitations on the power handling ability of a transistor: average junction temperature and second breakdown. Safe operating area curves indicate I_C – V_{CE} limits of the transistor that must be observed for reliable operation, i.e., the transistor must not be subjected to greater dissipation than the curves indicate.

The data of Figures 2 and 3 is based on T_{J(pk)} = 150°C; T_C is variable depending on conditions. Second breakdown pulse limits are valid for duty cycles to 10% provided T_{J(pk)} < 150°C. T_{J(pk)} may be calculated from the data in Figure 1. At high case temperatures, thermal limitations will reduce the power that can be handled to values less than the limitations imposed by second breakdown.

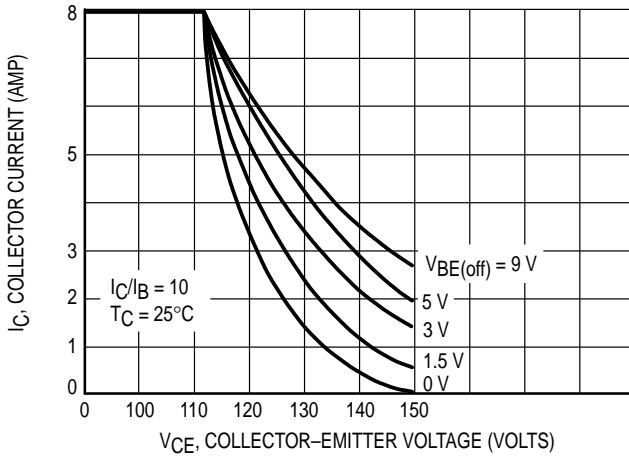

Figure 3. Reverse Bias Switching Safe Operating Area

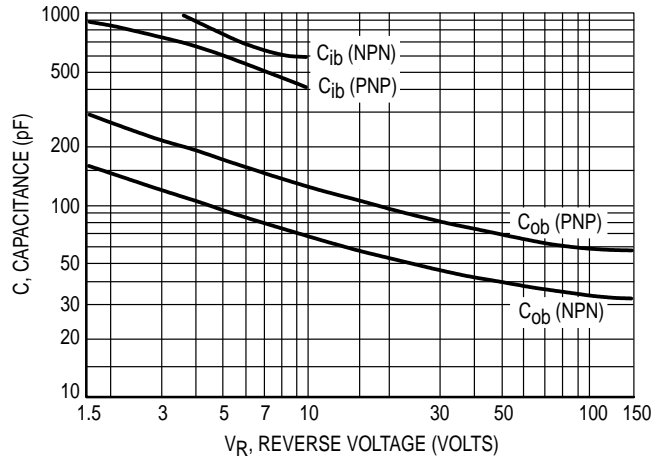

Figure 4. Capacitances

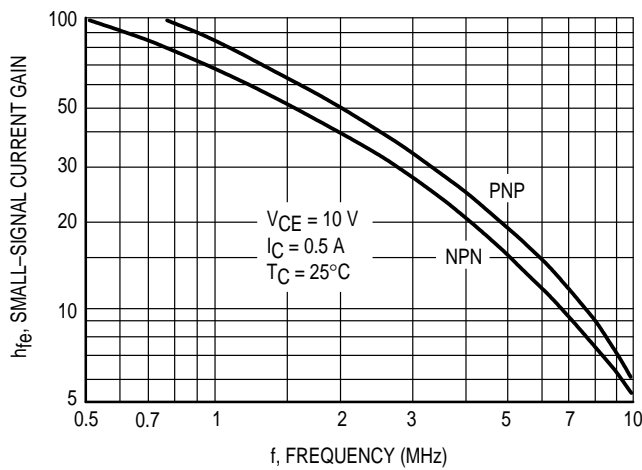

Figure 5. Small-Signal Current Gain

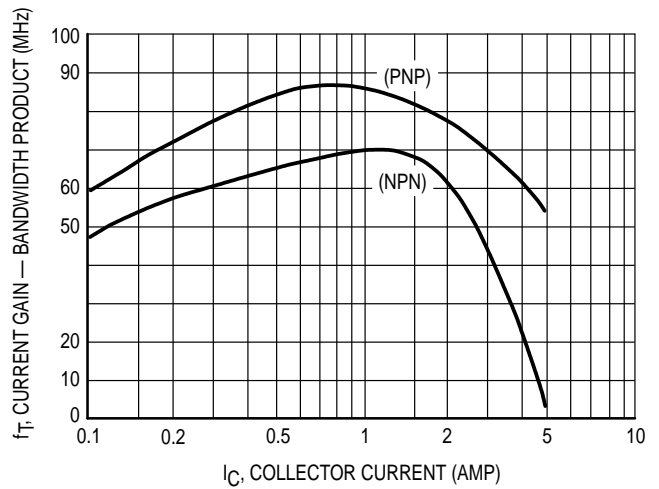

Figure 6. Current Gain — Bandwidth Product

DC CURRENT GAIN

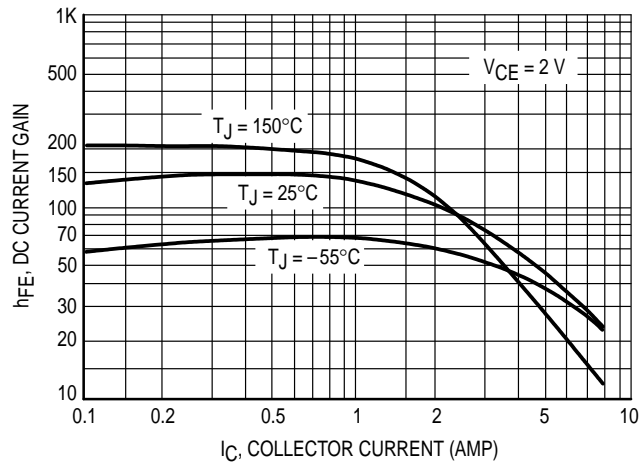

Figure 7a. MJF15030 NPN

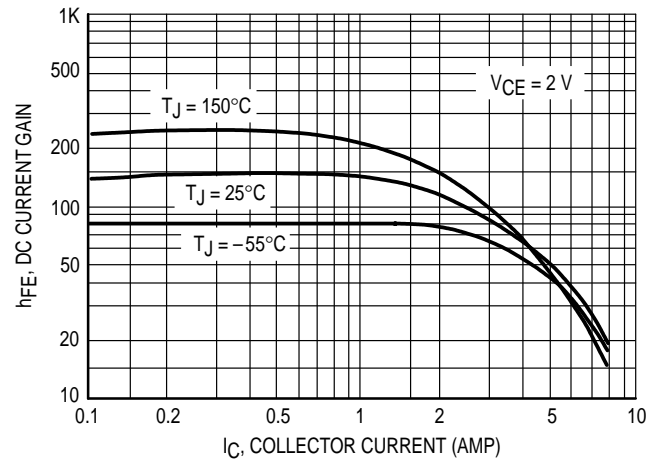

Figure 7b. MJF15031 PNP

“ON” VOLTAGE

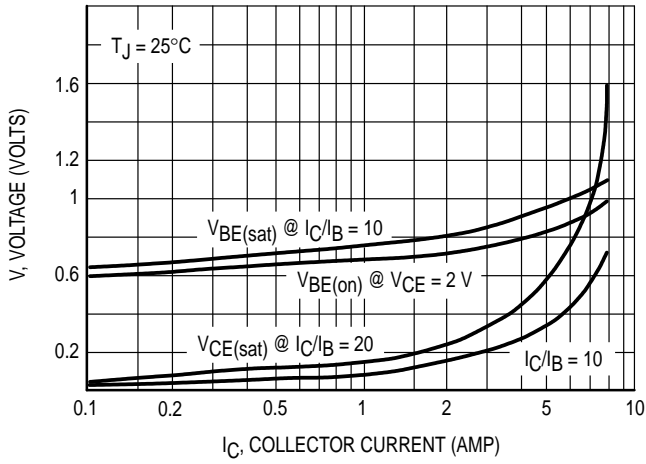

Figure 8a. MJF15030 NPN

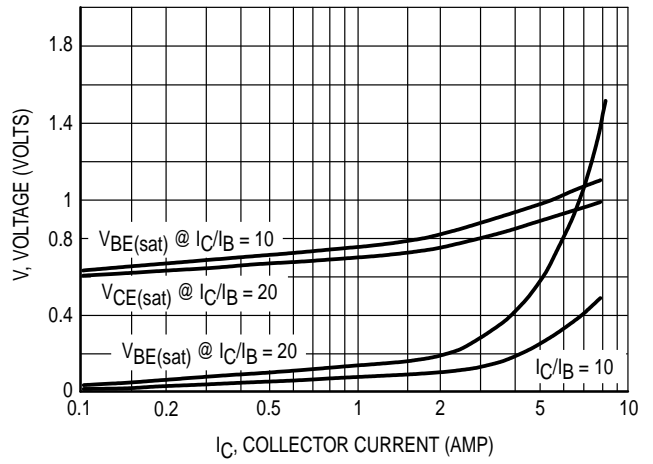

Figure 8b. MJF15031 PNP

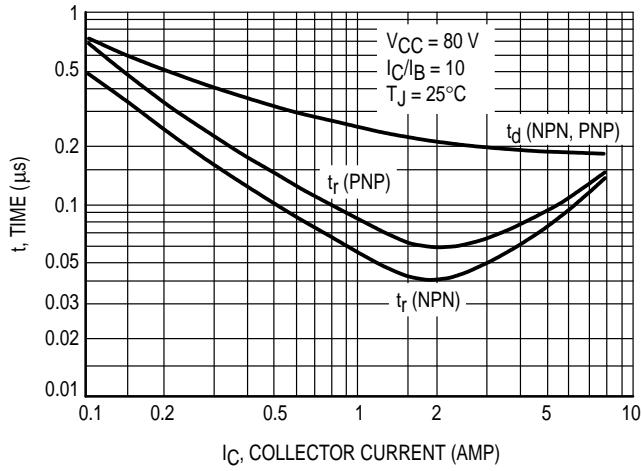

Figure 9. Turn-On Times

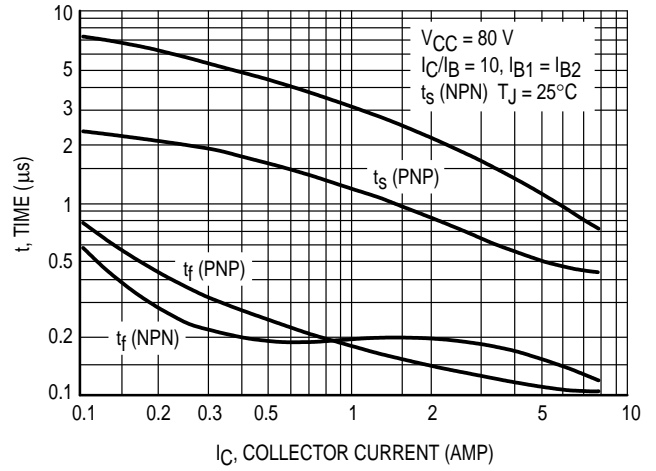
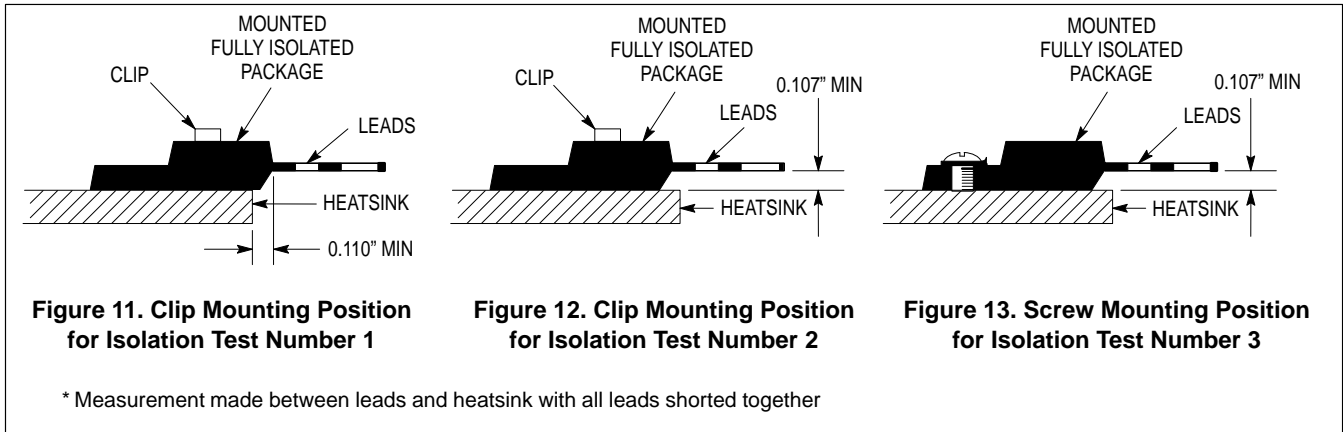

Figure 10. Turn-Off Times

TEST CONDITIONS FOR ISOLATION TESTS*



MOUNTING INFORMATION

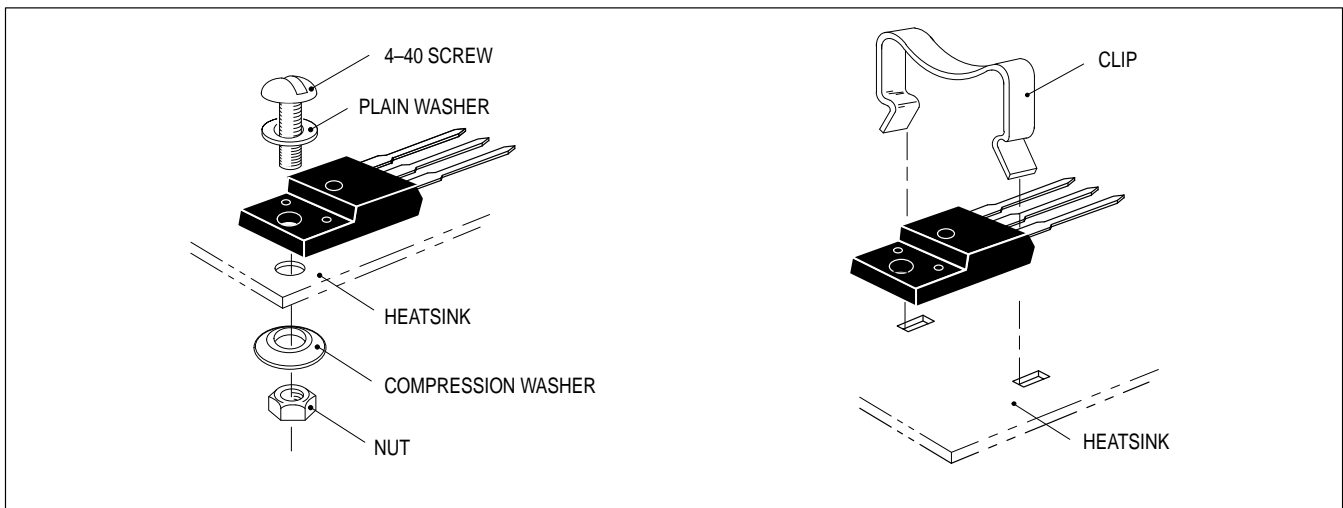

Figure 14. Typical Mounting Techniques*

Laboratory tests on a limited number of samples indicate, when using the screw and compression washer mounting technique, a screw torque of 6 to 8 in · lbs is sufficient to provide maximum power dissipation capability. The compression washer helps to maintain a constant pressure on the package over time and during large temperature excursions.

Destructive laboratory tests show that using a hex head 4-40 screw, without washers, and applying a torque in excess of 20 in · lbs will cause the plastic to crack around the mounting hole, resulting in a loss of isolation capability.

Additional tests on slotted 4-40 screws indicate that the screw slot fails between 15 to 20 in · lbs without adversely affecting the package. However, in order to positively ensure the package integrity of the fully isolated device, Motorola does not recommend exceeding 10 in · lbs of mounting torque under any mounting conditions.

** For more information about mounting power semiconductors see Application Note AN1040.

PACKAGE DIMENSIONS

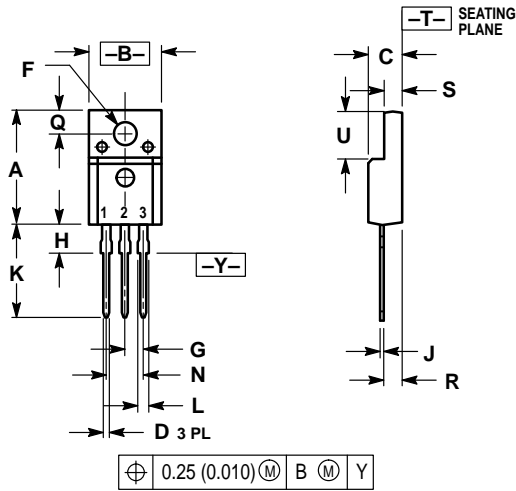

- NOTES:
 1. DIMENSIONING AND TOLERANCING PER ANSI Y14.5M, 1982.
 2. CONTROLLING DIMENSION: INCH.

DIM	INCHES		MILLIMETERS	
	MIN	MAX	MIN	MAX
A	0.621	0.629	15.78	15.97
B	0.394	0.402	10.01	10.21
C	0.181	0.189	4.60	4.80
D	0.026	0.034	0.67	0.86
F	0.121	0.129	3.08	3.27
G	0.100 BSC		2.54 BSC	
H	0.123	0.129	3.13	3.27
J	0.018	0.025	0.46	0.64
K	0.500	0.562	12.70	14.27
L	0.045	0.060	1.14	1.52
N	0.200 BSC		5.08 BSC	
Q	0.126	0.134	3.21	3.40
R	0.107	0.111	2.72	2.81
S	0.096	0.104	2.44	2.64
U	0.259	0.267	6.58	6.78

- STYLE 2:
 PIN 1. BASE
 2. COLLECTOR
 3. EMITTER

CASE 221D-02
 TO-220 TYPE
 ISSUE D

Motorola reserves the right to make changes without further notice to any products herein. Motorola makes no warranty, representation or guarantee regarding the suitability of its products for any particular purpose, nor does Motorola assume any liability arising out of the application or use of any product or circuit, and specifically disclaims any and all liability, including without limitation consequential or incidental damages. "Typical" parameters can and do vary in different applications. All operating parameters, including "Typicals" must be validated for each customer application by customer's technical experts. Motorola does not convey any license under its patent rights nor the rights of others. Motorola products are not designed, intended, or authorized for use as components in systems intended for surgical implant into the body, or other applications intended to support or sustain life, or for any other application in which the failure of the Motorola product could create a situation where personal injury or death may occur. Should Buyer purchase or use Motorola products for any such unintended or unauthorized application, Buyer shall indemnify and hold Motorola and its officers, employees, subsidiaries, affiliates, and distributors harmless against all claims, costs, damages, and expenses, and reasonable attorney fees arising out of, directly or indirectly, any claim of personal injury or death associated with such unintended or unauthorized use, even if such claim alleges that Motorola was negligent regarding the design or manufacture of the part. Motorola and \textcircled{M} are registered trademarks of Motorola, Inc. Motorola, Inc. is an Equal Opportunity/Affirmative Action Employer.

How to reach us:
 USA / EUROPE: Motorola Literature Distribution;
 P.O. Box 20912; Phoenix, Arizona 85036. 1-800-441-2447

JAPAN: Nippon Motorola Ltd.; Tatsumi-SPD-JLDC, Toshikatsu Otsuki,
 6F Seibu-Butsuryu-Center, 3-14-2 Tatsumi Koto-Ku, Tokyo 135, Japan. 03-3521-8315

MFAX: RMFAX0@email.sps.mot.com - TOUCHTONE (602) 244-6609
 INTERNET: http://Design-NET.com

HONG KONG: Motorola Semiconductors H.K. Ltd.; 8B Tai Ping Industrial Park,
 51 Ting Kok Road, Tai Po, N.T., Hong Kong. 852-26629298

