

## MSP430-GBD development board

## Users Manual



All boards produced by Olimex are ROHS compliant

Rev.A, November 2009

Copyright(c) 2009, OLIMEX Ltd, All rights reserved

## **INTRODUCTION**

**MSP430-GBD** development board is example how digital signal processing may be done with low cost and low power MSP430 microcontroller, the design is based on TI Application notes: SLAA351 Simple Glasbreak detector and SLAA389 Robust Glasbreak detector

Application software make it like simple glass break detector. There is led and buzzer indication when glass break is detected. The board can be used as sensor evaluation, introduction to digital filtering basis. The sources are available and can be modified by the user for their own further development.

## **BOARD FEATURES**

- CPU: MSP430F2274 mixed signal microcontroller
- JTAG connector
- UEXT connector
- Microphone
- Buzzer
- 3 V lithium battery connector
- Status LED
- PCB: FR-4, 1.5 mm (0,062"), solder mask, silkscreen component print
- Dimensions: 41.9x40.6 mm ( 1.650x 1.599")

## ELECTROSTATIC WARNING

The MSP430-GBD board is shipped in protective anti-static packaging. The board must not be subject to high electrostatic potentials. General practice for working with static sensitive devices should be applied when working with this board.

## BOARD USE REQUIREMENTS

**Cables:** The cable you will need depends on the programmer/debugger you use. If you use MSP430-JTAG, you will need LPT cable, if you use MSP430-JTAG-TINY or MSP-JTAG-ISO, you will need 1.8m A-B USB cable, if you use MSP430-JTAG-RF, you can connect it to the USB port of your computer, or via USB cable type A - female.

*Note: If you use MSP430-JTAG-RF - be sure that your battery gives power supply 3V, because if it is lower - MSP430-JTAG-RF may not work.*

**Hardware:** Programmer/Debugger - one of our Programmers - [MSP430-JTAG](#), [MSP430-JTAG-TINY](#), [MSP430-JTAG-ISO](#), or [MSP430-JTAG-RF](#).

**Software:** MSP430 KickStart software.

## PROCESSOR FEATURES

**MSP430-GBD** board use ultralow-power mixed signal microcontroller with two built-in 16-bit timers, a universal serial communication interface, 10-bit A/D converter with integrated reference and data transfer controller (DTC), two general-purpose operational amplifiers, 32 GPIO with these features:

- 32KB + 256B Flash Memory
- 1KB RAM
- Low Supply Voltage Range: 1.8 V to 3.6 V
- Ultralow Power Consumption
  - Active Mode: 270  $\mu$ A at 1 MHz, 2.2 V
  - Standby Mode: 0.7  $\mu$ A
  - Off Mode (RAM Retention): 0.1  $\mu$ A
- Ultrafast Wake-Up From Standby Mode in Less Than 1  $\mu$ s
- 16-Bit RISC Architecture, 62.5-ns Instruction Cycle Time
- Basic Clock Module Configurations:
  - Internal Frequencies up to 16 MHz With Four Calibrated Frequencies to  $\pm 1\%$
  - Internal Very-Low-Power Low-Frequency Oscillator
  - 32-kHz Crystal

- High-Frequency Crystal 16 MHz
  - Resonator
  - External Digital Clock Source
  - External Resistor
- 16-Bit Timer\_A With Three Capture/Compare Registers
- 16-Bit Timer\_B With Three Capture/Compare Registers
- Universal Serial Communication Interface
  - Enhanced UART Supporting Auto-Baudrate Detection (LIN)
  - IrDA Encoder and Decoder
  - Synchronous SPI
  - I<sup>2</sup>C™
- 10-Bit 200-ksps Analog-to-Digital (A/D) Converter With Internal Reference, Sample-and-Hold, Autoscan, and Data Transfer Controller
- Two Configurable Operational Amplifiers
- Brownout Detector
- Serial Onboard Programming, No External Programming Voltage Needed
- Programmable Code Protection by Security Fuse
- Bootstrap Loader
- On Chip Emulation Module

## BLOCK DIAGRAM

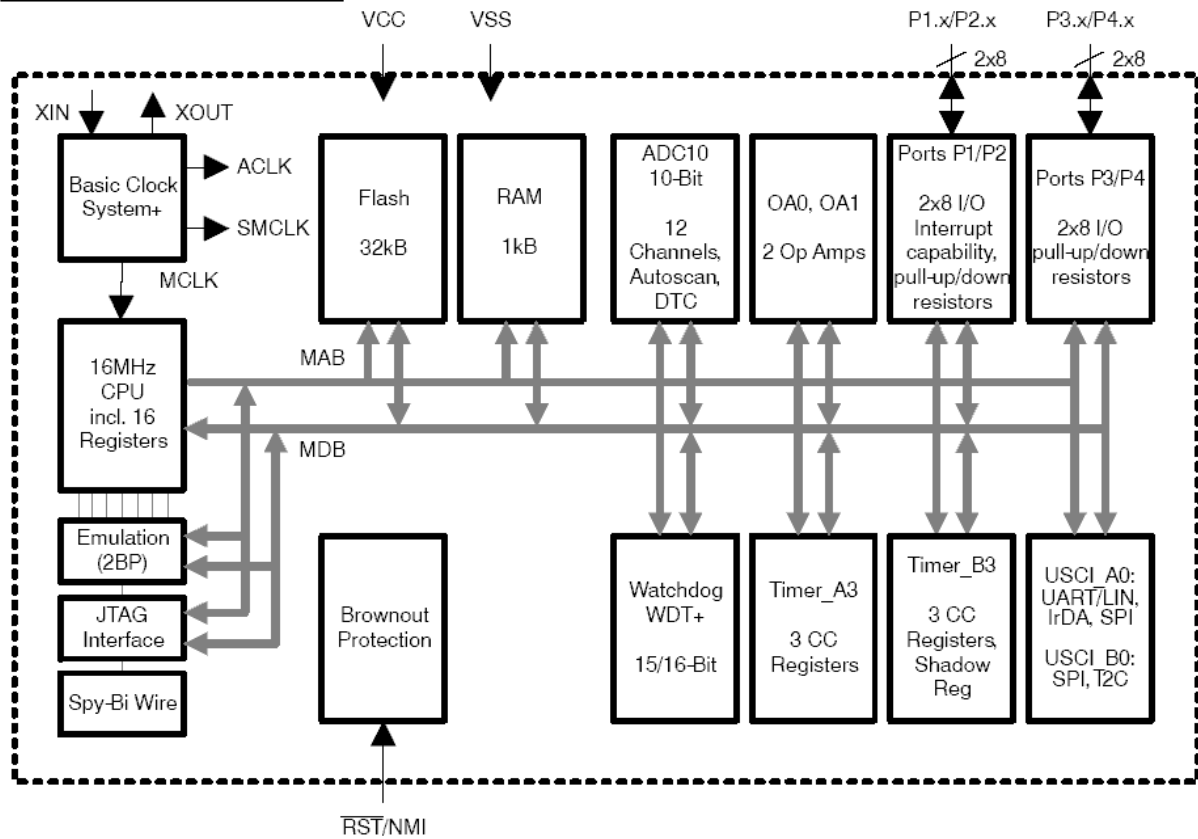

## MEMORY ORGANIZATION

MSP430F2274		
Memory Main: interrupt vector Main: code memory Information memory	Size	32KB Flash
	Flash	0FFFFh-0FFC0h
	Flash	0FFFFh-08000h
Boot memory	Size	256 Byte
	Flash	010FFh-01000h
RAM	Size	1KB
Peripherals	16-bit	0FFFh-0C00h
	8-bit	0FFh-010h
	8-bit SFR	0Fh-00h

# SCHEMATIC

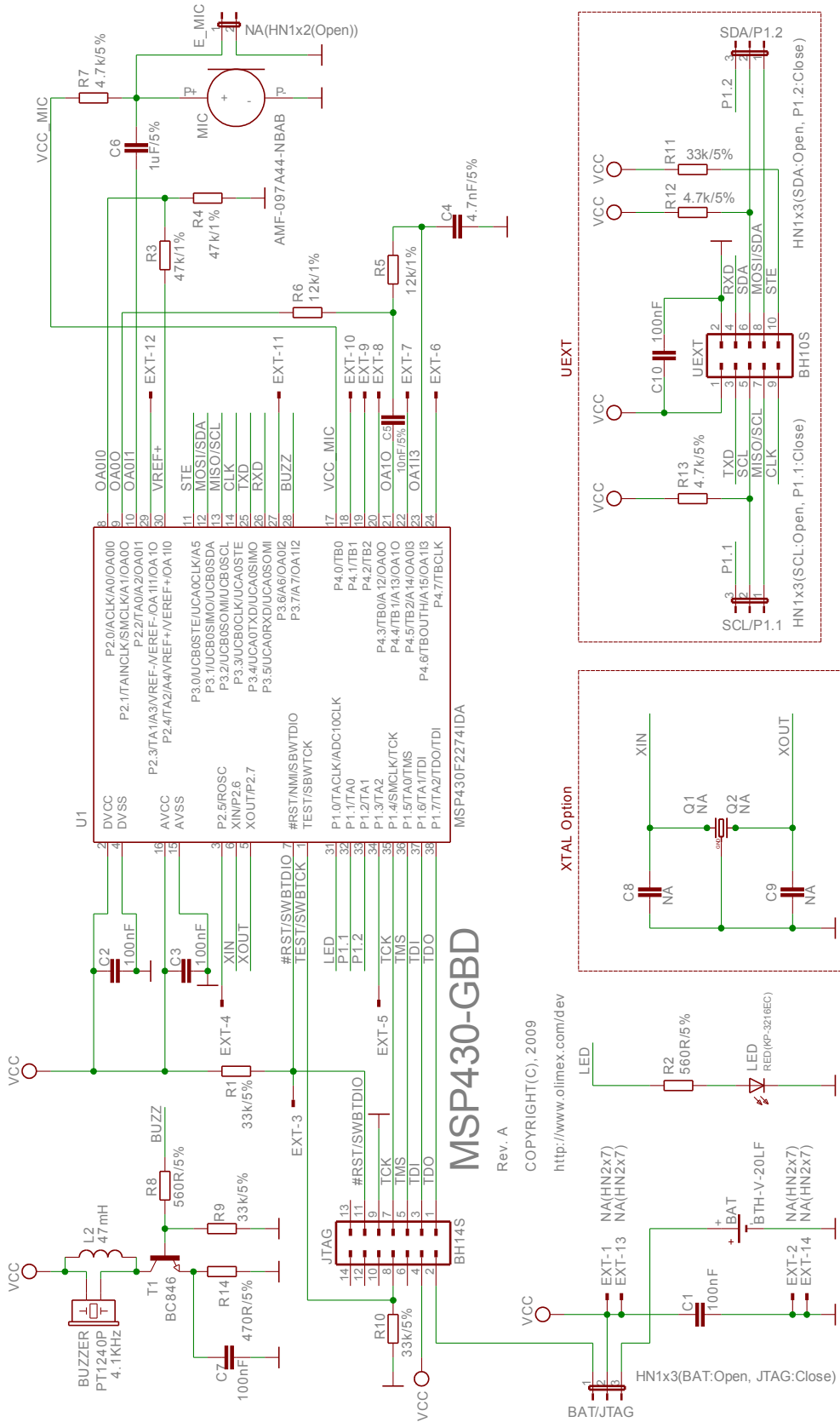

**BOARD LAYOUT**

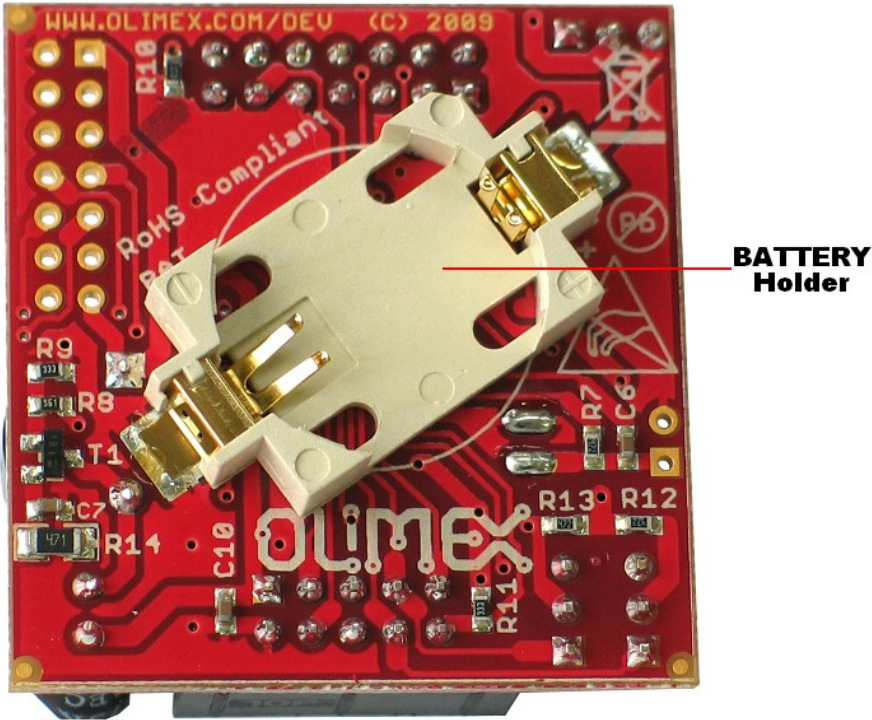
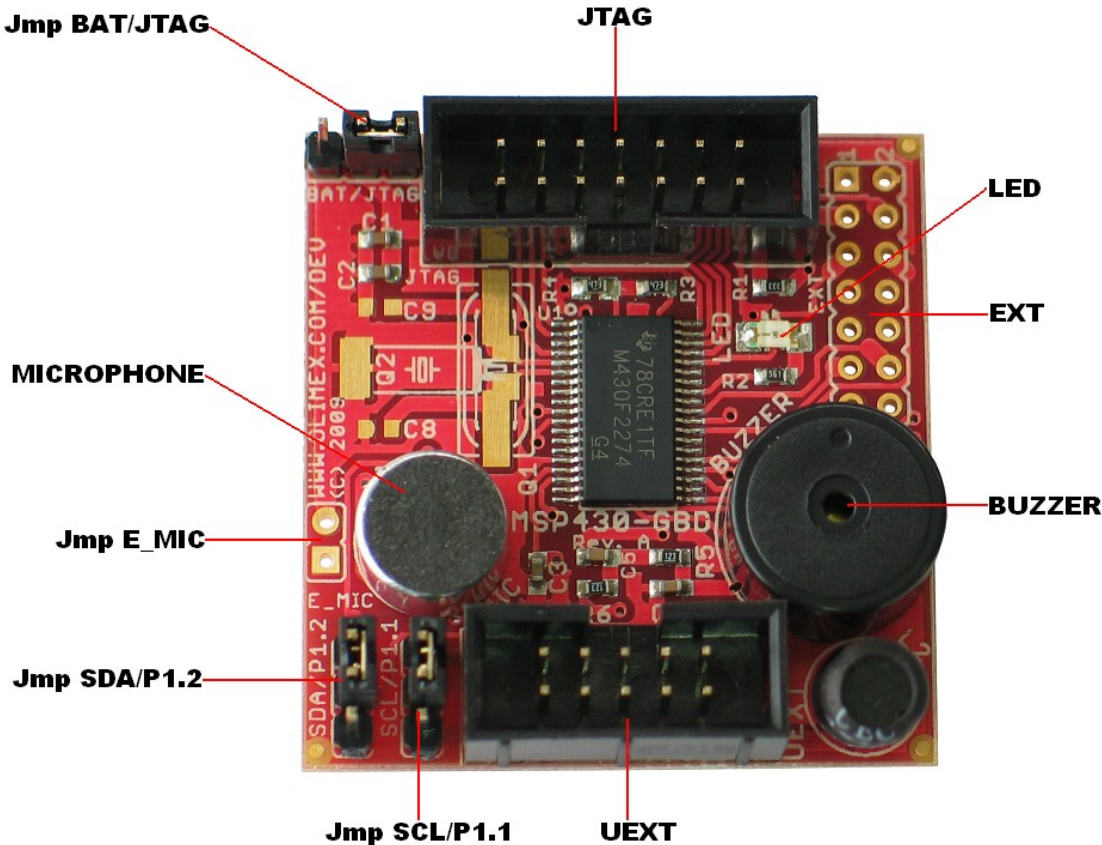

## POWER SUPPLY CIRCUIT

MSP430-GBD can take power from two sources:

- Battery, when jumper BAT/JTAG is in position BAT.
- JTAG, when jumper BAT/JTAG is in position JTAG.

## RESET CIRCUIT

MSP430-GBD reset circuit includes JTAG connector pin 11, EXT pin 3, MSP430F2274 pin 7 (#RST/NMI/SBWDIO).

## CLOCK CIRCUIT

There is XTAL option for the customer. You can connect quartz crystal to MSP430F2274 pin 5 (XOUT/P2.7) and pin 6 (XIN/P2.6).

## JUMPER DESCRIPTION

### SDA/P1.2



Give user choice to select UEXT SDA connection between P1.2 or MOSI/SDA.  
Default state is P1.2.

### SCL/P1.1



Give user choice to select UEXT SCL connection between P1.1 or MISO/SCL.  
Default state is P1.1.

### BAT/JTAG



Give user opportunity to select between battery power supply or JTAG power supply.  
Default state is JTAG.

### E\_MIC



Give user opportunity to connect external microphone instead on-board microphone.  
Default state is not connected.

## INPUT/OUTPUT

**Status LED (red)** with name LED - light indication for recognizing glass breakage, connected to MSP430F2274 pin 31 (P1.0).

**BUZZER** - audio indication for glass breakage, connected to MSP430F2274 pin 28 (P3.7)

**MIC** - on-board microphone - sensor for recognizing glass breakage, connected to MSP430F2274 pin 17 (P4.0) - VCC\_MIC, through R7(4.7k) and pin 10 (DA0I1), through C(1uF).



# CONNECTOR DESCRIPTIONS

## JTAG

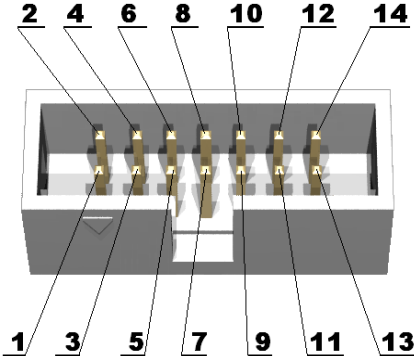

Pin #	Signal Name	Pin #	Signal Name
1	TDO	2	VCC_JTAG
3	TDI	4	VCC
5	TMS	6	NC
7	TCK	8	TEST/SWBTCK
9	GND	10	NC
11	#RST/SWBDIO	12	NC
13	NC	14	NC

## EXT

Pin #	Signal Name	Pin #	Signal Name
1	VCC	2	GND
3	#RST/SWBDIO	4	P2.5
5	P1.3	6	P4.7
7	P4.5	8	P4.3
9	P4.2	10	P4.1
11	P3.6	12	P2.3
13	VCC	14	GND

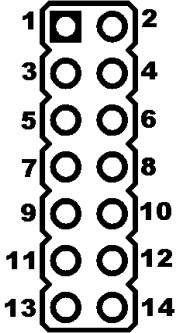

## UEXT

Pin #	Signal Name
1	VCC
2	GND
3	TXD
4	RXD
5	SCL
6	SDA
7	MISO/SCL
8	MOSI/SDA
9	CLK
10	STE

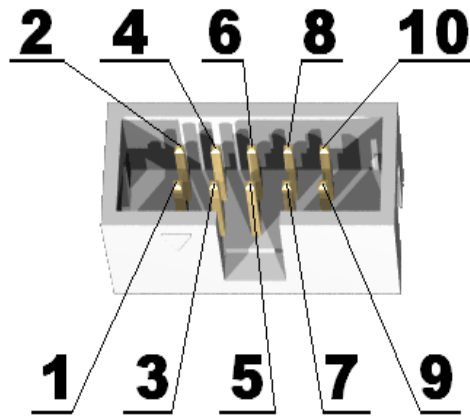

**MECHANICAL DIMENSIONS**

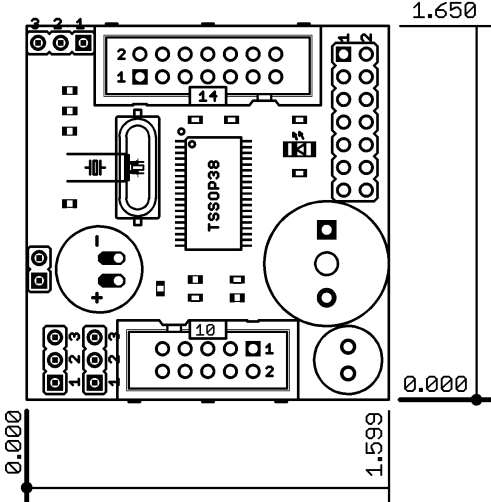

All measures are in inches.

## **AVAILABLE DEMO SOFTWARE**

- MSP430-GBD\_Blinking\_Led
- MSP430-GBD\_Buzzer\_Beep
- MSP430-GBD\_Glass\_Break

## **ORDER CODE**

**MSP430-GBD** - assembled and tested

How to order?

You can order to us directly or by any of our distributors.

Check our web [www.olimex.com/dev](http://www.olimex.com/dev) for more info.

### **Revision history:**

REV.A                    - create   November 2009

**Disclaimer:**

© 2009 Olimex Ltd. All rights reserved. Olimex®, logo and combinations thereof, are registered trademarks of Olimex Ltd. Other terms and product names may be trademarks of others.

The information in this document is provided in connection with Olimex products. No license, express or implied or otherwise, to any intellectual property right is granted by this document or in connection with the sale of Olimex products.

Neither the whole nor any part of the information contained in or the product described in this document may be adapted or reproduced in any material from except with the prior written permission of the copyright holder.

The product described in this document is subject to continuous development and improvements. All particulars of the product and its use contained in this document are given by OLIMEX in good faith. However all warranties implied or expressed including but not limited to implied warranties of merchantability or fitness for purpose are excluded.

This document is intended only to assist the reader in the use of the product. OLIMEX Ltd. shall not be liable for any loss or damage arising from the use of any information in this document or any error or omission in such information or any incorrect use of the product.