



## PolySwitch Resettable Devices Radial-leaded Devices

TE Circuit Protection's PolySwitch radial-leaded products represent the most comprehensive and complete set of PPTC products available in the industry today.

- RGEF series for hold currents up to 14A
- RHEF series for flatter thermal derating and operating temperatures up to 125°C
- RUEF series for balance of voltage rating (30V) and hold current (up to 9A)
- RUSBF series for fast time-to-trip and low-resistance computer applications
- RXEF series for low hold currents (down to 50mA) and high voltage rating (up to 72V)
- RKEF series for balance of voltage rating (60V) and hold current (up to 5A)
- BBRF series for cable telephone applications
- Now offering RoHS versions of all products



### Benefits

- Many product choices give engineers more design flexibility
- Compatible with high-volume electronics assembly
- Assists in meeting regulatory requirements
- Higher voltage ratings allow use in new applications

### Features

- RoHS compliant
- Broadest range of radial-leaded resettable devices available in the industry
- Current ratings from 50mA to 15A
- Voltage ratings from 6V (computer and electronic applications) to 99V
- Agency recognition : UL, CSA, TÜV
- Fast time-to-trip
- Low resistance

### Applications

- |                             |                                  |                                 |
|-----------------------------|----------------------------------|---------------------------------|
| • Satellite video receivers | • USB hub, ports and peripherals | • Phones                        |
| • Industrial controls       | • IEEE1394 ports                 | • Fax machines                  |
| • Transformers              | • CD-ROMs                        | • Analog and digital line cards |
| • Computer motherboards     | • Game machines                  | • Printers                      |
| • Modems                    | • Battery packs                  |                                 |

## Application Selection Guide for Radial-leaded Devices

The guide below lists PolySwitch radial-leaded devices that are typically used in these applications. Specifications for the suggested device part numbers can be found in this section. Once a part number has been selected, the user should evaluate and test each product for its intended application.

### PolySwitch Resettable Devices — Key Selection Criteria

Protection Application	Small Size	Flatter Derating	Lower Current Higher Voltage
Electromagnetic loads	RGEF (<16V), RUEF (<30V)	RHEF (<16V)	RXEF (<72V), RKEF(<60V)
Halogen lighting	RGEF (<16V), RUEF (<30V)	RHEF (<16V)	RXEF (<72V), RKEF(<60V)
Lighting ballast	RXEF (<72V), BBRF (<99V)		
Loudspeakers	RXEF (<72V)		RXEF (<72V), RKEF(<60V)
Medical equipment	RGEF (<16V), RUEF (<30V)	RHEF (<16V)	RXEF (<72V), RKEF(<60V)
MOSFET devices	RGEF (<16V), RUEF (<30V)	RHEF (<16V)	RXEF (<72V), RKEF(<60V)
Motors, fans and blowers	RXEF (<72V), RGEF (<16V)	RHEF (<16V)	
POS equipment	RXEF (<72V), RUEF (<30V)		
Process and industrial controls	RXEF (<72V), RUEF (<30V)		
Satellite video receivers	RGEF (<16V), RUEF (<30V)	RHEF (<16V)	RXEF (<72V), RKEF(<60V)
Security and fire alarm systems	RGEF (<16V), RUEF (<30V)	RHEF (<16V)	RXEF (<72V), RKEF(<60V)
Test and measurement equipment	RGEF (<16V), RUEF (<30V)	RHEF (<16V)	RXEF (<72V), RKEF(<60V)
Transformers	RGEF (<16V), RUEF (<30V)	RHEF (<16V)	RXEF (<72V), RKEF(<60V)
DDC computer and consumer electronics	RUEF (<30V)		
Mouse and keyboard	RUEF (<30V)		
SCSI	RUEF (<30V)		
USB	RUSBF (<16V)		
Traces and printed circuit board protection	RGEF (<16V), RUEF (<30V)	RHEF (<16V)	RXEF (<72V), RKEF(<60V)

**Note:** This list is not exhaustive. TE Circuit Protection welcomes customer's input for additional application ideas for PolySwitch resettable devices.

**Table R1** Product Series - Current Rating, Voltage Rating / Typical Resistance for Radial-leaded Devices

Voltage Rating	BBRF 99V	RXEF 72V	RKEF 60V	RXEF 60V	RUEF 30V	RGEF 16V	RHEF 16V	RHEF 30V	RUSBF 16V	RUSBF 6V
<b>Hold Current (A)</b>										
0.050	—	—	—	9.20Ω	—	—	—	—	—	—
0.100	—	—	—	3.50Ω	—	—	—	—	—	—
0.170	—	—	—	4.30Ω	—	—	—	—	—	—
0.200	—	2.290Ω	—	—	—	—	—	—	—	—
0.250	—	1.600Ω	—	—	—	—	—	—	—	—
0.300	—	1.110Ω	—	—	—	—	—	—	—	—
0.400	—	0.710Ω	—	—	—	—	—	—	—	—
0.500	—	0.640Ω	0.425Ω	—	—	—	—	0.68Ω	—	—
0.550	1.05Ω	—	—	—	—	—	—	—	—	—
0.650	—	0.400Ω	0.350Ω	—	—	—	—	—	—	—
0.700	—	—	—	—	—	—	—	0.42Ω	—	—
0.750	—	0.325Ω	0.295Ω	—	—	—	—	—	—	0.140Ω
0.900	—	0.255Ω	0.255Ω	—	0.095Ω	—	—	—	0.100Ω	—
1.000	—	—	—	—	—	—	—	0.24Ω	—	—
1.100	—	0.200Ω	0.225Ω	—	0.075Ω	—	—	—	0.075Ω	—
1.200	—	—	—	—	—	—	—	—	—	0.080Ω
1.350	—	0.155Ω	0.165Ω	—	0.060Ω	—	—	—	0.060Ω	—
1.550	—	—	—	—	—	—	—	—	—	0.058Ω
1.600	—	0.115Ω	0.150Ω	—	0.050Ω	—	—	—	0.050Ω	—
1.850	—	0.100Ω	0.106Ω	—	0.045Ω	—	—	—	0.045Ω	—
1.900	—	—	—	—	—	—	—	—	—	—

**Table R1** Product Series - Current Rating, Voltage Rating / Typical Resistance for Radial-leaded Devices Cont'd

Voltage Rating	BBRF 99V	RXEF 72V	RKEF 60V	RXEF 60V	RUEF 30V	RGEF 16V	RHEF 16V	RHEF 30V	RUSBF 16V	RUSBF 6V
<b>Hold Current (A)</b>										
2.000	—	—	—	—	—	—	0.0610Ω	—	—	—
2.500	—	0.065Ω	0.063Ω	—	0.030Ω	0.0380Ω	—	—	0.030Ω	—
3.000	—	0.050Ω	0.040Ω	—	0.035Ω	0.0514Ω	0.0430Ω	—	—	—
3.750	—	0.040Ω	0.029Ω	—	—	—	—	—	—	—
4.000	—	—	0.026Ω	—	0.020Ω	0.0300Ω	0.0320Ω	—	—	—
4.500	—	—	—	—	—	—	0.0290Ω	—	—	—
5.000	—	—	0.021Ω	—	0.020Ω	0.0192Ω	—	—	—	—
5.500	—	—	—	—	—	—	0.0200Ω	—	—	—
6.000	—	—	—	—	0.013Ω	0.0145Ω	0.0175Ω	—	—	—
6.500	—	—	—	—	—	—	0.0144Ω	—	—	—
7.000	—	—	—	—	0.013Ω	0.0105Ω	0.0132Ω	—	—	—
7.500	—	—	—	—	—	—	0.0120Ω	—	—	—
8.000	—	—	—	—	0.013Ω	0.0086Ω	0.0110Ω	—	—	—
9.000	—	—	—	—	0.008Ω	0.0070Ω	0.0100Ω	—	—	—
10.00	—	—	—	—	—	0.0056Ω	0.0083Ω	—	—	—
11.00	—	—	—	—	—	0.0050Ω	0.0073Ω	—	—	—
12.00	—	—	—	—	—	0.0046Ω	—	—	—	—
13.00	—	—	—	—	—	—	0.0055Ω	—	—	—
14.00	—	—	—	—	—	0.0040Ω	0.0050Ω	—	—	—
15.00	—	—	—	—	—	—	0.0050Ω	—	—	—

**Table R2** Thermal Derating for Radial-leaded Devices [Hold Current (A) at Ambient Temperature (°C)]

Part Number	Maximum Ambient Temperature										
	-40°C	-20°C	0°C	20°C	25°C	40°C	50°C	60°C	70°C	85°C	125°C
<b>BBRF 99V</b>											
BBRF550	0.85	0.75	0.65	0.55	—	0.45	0.40	0.35	0.30	0.22	—
<b>RXEF 60V</b>											
RXEF005	0.078	0.068	0.06	0.05	0.048	0.04	0.035	0.032	0.027	0.02	—
RXEF010	0.160	0.140	0.11	0.10	0.096	0.08	0.072	0.067	0.050	0.04	—
RXEF017	0.260	0.230	0.21	0.17	0.160	0.14	0.120	0.110	0.090	0.07	—
<b>RXEF 72V</b>											
RXEF020	0.31	0.27	0.24	0.20	0.19	0.16	0.14	0.13	0.11	0.08	—
RXEF025	0.39	0.34	0.30	0.25	0.24	0.20	0.18	0.16	0.14	0.10	—
RXEF030	0.47	0.41	0.36	0.30	0.29	0.24	0.22	0.20	0.16	0.12	—
RXEF040	0.62	0.54	0.48	0.40	0.38	0.32	0.29	0.25	0.22	0.16	—
RXEF050	0.78	0.68	0.60	0.50	0.48	0.41	0.36	0.32	0.27	0.20	—
RXEF065	1.01	0.88	0.77	0.65	0.62	0.53	0.47	0.41	0.35	0.26	—
RXEF075	1.16	1.02	0.89	0.75	0.72	0.61	0.54	0.47	0.41	0.30	—
RXEF090	1.40	1.22	1.07	0.90	0.86	0.73	0.65	0.57	0.49	0.36	—
RXEF110	1.71	1.50	1.31	1.10	1.06	0.89	0.79	0.69	0.59	0.44	—
RXEF135	2.09	1.84	1.61	1.35	1.30	1.09	0.97	0.85	0.73	0.54	—
RXEF160	2.48	2.18	1.90	1.60	1.54	1.30	1.15	1.01	0.86	0.64	—
RXEF185	2.87	2.52	2.20	1.85	1.78	1.50	1.33	1.17	1.00	0.74	—
RXEF250	3.88	3.40	2.98	2.50	2.40	2.03	1.80	1.58	1.35	1.00	—
RXEF300	4.65	4.08	3.57	3.00	2.88	2.43	2.16	1.89	1.62	1.20	—
RXEF375	5.81	5.10	4.46	3.75	3.60	3.04	2.70	2.36	2.03	1.50	—

**Table R2 Thermal Derating for Radial-leaded Devices**  
**[Hold Current (A) at Ambient Temperature (°C)]**

Cont'd

Part Number	Maximum Ambient Temperature										
	-40°C	-20°C	0°C	20°C	25°C	40°C	50°C	60°C	70°C	85°C	125°C
<b>RKEF</b>											
<b>60V</b>											
RKEF050	0.73	0.65	0.58	0.50	0.48	0.42	0.38	0.34	0.31	0.26	—
RKEF065	0.94	0.85	0.75	0.65	0.63	0.54	0.50	0.44	0.40	0.34	—
RKEF075	1.09	0.98	0.86	0.75	0.73	0.62	0.58	0.51	0.46	0.39	—
RKEF090	1.30	1.17	1.04	0.90	0.87	0.75	0.69	0.61	0.55	0.47	—
RKEF110	1.60	1.43	1.27	1.10	1.06	0.92	0.85	0.75	0.67	0.57	—
RKEF135	1.96	1.76	1.55	1.35	1.31	1.12	1.04	0.92	0.83	0.71	—
RKEF160	2.32	2.08	1.84	1.60	1.55	1.33	1.23	1.08	0.98	0.83	—
RKEF185	2.68	2.41	2.13	1.85	1.79	1.54	1.43	1.26	1.13	0.96	—
RKEF250	3.63	3.25	2.88	2.50	2.43	2.08	1.93	1.70	1.52	1.31	—
RKEF300	4.35	3.90	3.45	3.00	2.91	2.50	2.30	2.04	1.84	1.55	—
RKEF375	5.44	4.88	4.31	3.75	3.64	3.11	2.90	2.54	2.29	1.94	—
RKEF400	5.80	5.20	4.60	4.00	3.88	3.32	3.08	2.73	2.45	2.08	—
RKEF500	7.25	6.50	5.75	5.00	4.85	4.15	3.85	3.41	3.06	2.59	—
<b>RUEF</b>											
<b>30V</b>											
RUEF090	1.31	1.17	1.04	0.90	0.87	0.75	0.69	0.61	0.55	0.47	—
RUEF110	1.60	1.43	1.27	1.10	1.07	0.91	0.85	0.75	0.67	0.57	—
RUEF135	1.96	1.76	1.55	1.35	1.31	1.12	1.04	0.92	0.82	0.70	—
RUEF160	2.32	2.08	1.84	1.60	1.55	1.33	1.23	1.09	0.98	0.83	—
RUEF185	2.68	2.41	2.13	1.85	1.79	1.54	1.42	1.26	1.13	0.96	—
RUEF250	3.63	3.25	2.88	2.50	2.43	2.08	1.93	1.70	1.53	1.30	—
RUEF300	4.35	3.90	3.45	3.00	2.91	2.49	2.31	2.04	1.83	1.56	—
RUEF400	5.80	5.20	4.60	4.00	3.88	3.32	3.08	2.72	2.44	2.08	—
RUEF500	7.25	6.50	5.75	5.00	4.85	4.15	3.85	3.40	3.05	2.60	—
RUEF600	8.70	7.80	6.90	6.00	5.82	4.98	4.62	4.08	3.66	3.12	—
RUEF700	10.15	9.10	8.05	7.00	6.79	5.81	5.39	4.76	4.27	3.64	—
RUEF800	11.60	10.40	9.20	8.00	7.76	6.64	6.16	5.44	4.88	4.16	—
RUEF900	13.05	11.70	10.35	9.00	8.73	7.47	6.93	6.12	5.49	4.68	—
<b>RHEF</b>											
<b>30V - High Temperature</b>											
RHEF050	0.68	0.62	0.56	0.51	0.50	0.44	0.40	0.36	0.34	0.28	0.12
RHEF070	0.95	0.87	0.79	0.72	0.70	0.62	0.56	0.51	0.47	0.39	0.17
RHEF100	1.36	1.24	1.13	1.03	1.00	0.89	0.80	0.73	0.67	0.56	0.24
<b>RUSBF</b>											
<b>16V</b>											
RUSBF090	1.31	1.17	1.04	0.90	0.87	0.75	0.69	0.61	0.55	0.47	—
RUSBF110	1.60	1.43	1.27	1.10	1.07	1.00	0.92	0.75	0.67	0.57	—
RUSBF135	1.96	1.76	1.55	1.35	1.31	1.12	1.04	0.92	0.82	0.70	—
RUSBF160	2.32	2.08	1.84	1.60	1.55	1.33	1.23	1.09	0.98	0.83	—
RUSBF185	2.68	2.41	2.13	1.85	1.79	1.54	1.42	1.26	1.13	0.96	—
RUSBF250	3.63	3.25	2.88	2.50	2.43	2.08	1.93	1.70	1.53	1.30	—
<b>RGEF</b>											
<b>16V</b>											
RGEF250	3.7	3.3	3.0	2.6	2.50	2.2	2.0	1.8	1.6	1.2	—
RGEF300	4.4	4.0	3.6	3.1	3.00	2.6	2.4	2.1	1.9	1.4	—
RGEF400	5.9	5.3	4.8	4.1	4.00	3.5	3.2	2.8	2.5	1.9	—
RGEF500	7.3	6.6	6.0	5.2	5.00	4.4	4.0	3.6	3.1	2.4	—
RGEF600	8.8	8.0	7.2	6.2	6.00	5.2	4.8	4.2	3.8	2.8	—
RGEF700	10.3	9.3	8.4	7.3	7.00	6.2	5.6	5.0	4.4	3.3	—
RGEF800	11.7	10.7	9.6	8.3	8.00	6.9	6.4	5.6	5.1	3.7	—
RGEF900	13.2	11.9	10.7	9.4	9.00	7.9	7.2	6.4	5.6	4.2	—
RGEF1000	14.7	13.3	12.0	10.3	10.00	8.7	8.0	7.0	6.3	4.7	—
RGEF1100	16.1	14.6	13.1	11.5	11.00	9.7	8.8	7.8	6.9	5.2	—
RGEF1200	17.6	16.0	14.4	12.4	12.00	10.4	9.6	8.4	7.6	5.6	—
RGEF1400	20.5	18.7	16.8	14.5	14.00	12.1	11.2	9.8	8.9	6.5	—

**Table R2 Thermal Derating for Radial-leaded Devices [Hold Current (A) at Ambient Temperature (°C)]** Cont'd

Part Number	Maximum Ambient Temperature										
	-40°C	-20°C	0°C	20°C	25°C	40°C	50°C	60°C	70°C	85°C	125°C
<b>RHEF</b>											
<b>16V - High Temperature</b>											
RHEF200	2.71	2.49	2.26	2.06	2.00	1.77	1.60	1.46	1.34	1.11	0.49
RHEF300	4.07	3.74	3.41	3.09	3.00	2.65	2.40	2.21	2.00	1.66	0.74
RHEF400	5.57	5.11	4.65	4.22	4.00	3.62	3.29	3.01	2.73	2.27	1.01
RHEF450	6.10	5.60	5.10	4.60	4.50	4.00	3.60	3.30	3.00	2.50	1.10
RHEF550	7.47	6.86	6.24	5.66	5.50	4.85	4.41	4.04	3.66	3.05	1.36
RHEF600	8.20	7.50	6.80	6.20	6.00	5.30	4.90	4.40	4.00	3.30	1.50
RHEF650	8.80	8.10	7.40	6.70	6.50	5.70	5.30	4.80	4.30	3.60	1.60
RHEF700	9.51	8.73	7.95	7.20	7.00	6.17	5.61	5.15	4.66	3.88	1.73
RHEF750	10.20	9.40	8.60	7.70	7.50	6.60	6.10	5.60	5.00	4.10	1.90
RHEF800	10.87	9.98	9.08	8.23	8.00	7.06	6.41	5.88	5.33	4.43	1.97
RHEF900	12.21	11.19	10.16	9.26	9.00	7.97	7.20	6.56	6.04	5.01	2.19
RHEF1000	13.60	12.50	11.40	10.30	10.00	8.80	8.10	7.40	6.60	5.50	2.50
RHEF1100	14.94	13.72	12.49	11.31	11.00	9.70	8.82	8.09	7.32	6.09	2.71
RHEF1300	17.70	16.30	14.80	13.40	13.00	11.40	10.50	9.60	8.60	7.20	3.30
RHEF1400	19.01	17.46	15.89	14.40	14.00	12.35	11.22	10.29	9.32	7.76	3.45
RHEF1500	20.40	18.80	17.10	15.50	15.00	13.20	12.10	11.10	9.90	8.30	3.80
<b>RUSBF</b>											
<b>6V</b>											
RUSBF075	1.05	0.95	0.85	0.75	0.73	0.65	0.60	0.55	0.50	0.43	—
RUSBF120	1.69	1.52	1.36	1.20	1.16	1.04	0.96	0.88	0.80	0.68	—
RUSBF155	2.17	1.96	1.75	1.55	1.50	1.34	1.24	1.14	1.03	0.88	—

**Figure R1-R5 Thermal Derating Curve for Radial-leaded Devices**

RXEF and BBRF



RKEF

Figure R2



A = RUSBF075,  
RUSBF120,  
RUSBF155

B = RUEF,  
and all other RUSBF

Figure R3



RHEF

Figure R4



**Figure R1-R5 Thermal Derating Curve for Radial-leaded Devices**

Cont'd

RGEF

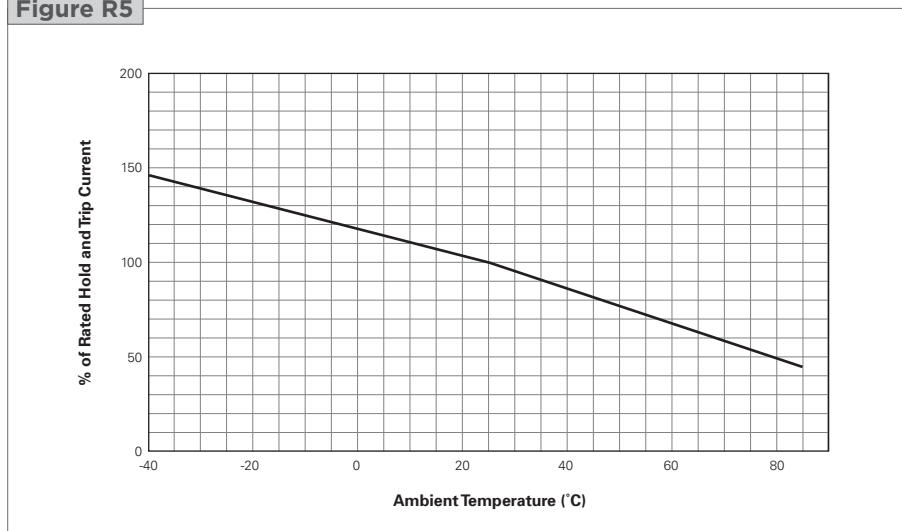
**Figure R5**

**Table R3 Electrical Characteristics for Radial-leaded Devices**

Part Number	$I_H$ (A)	$I_T$ (A)	$V_{MAX}$ (V)	$I_{MAX}$ (A)	$P_{D,Typ}$ (W)	Max. Time-to-trip		$R_{MIN}$ ( $\Omega$ )	$R_{MAX}$ ( $\Omega$ )	$R_{1MAX}$ ( $\Omega$ )	Lead Size [mm <sup>2</sup> (AWG)]
						(A)	(s)				
<b>BBRF 99V</b>											
BBRF550	0.55	1.10	99	20	1.5	1.60	60	0.8	1.30	1.95	[0.520mm <sup>2</sup> (20)]
<b>RXEF 60V</b>											
RXEF005	0.05	0.10	60	40	0.22	0.25	5.0	7.3	11.10	20.00	[0.128mm <sup>2</sup> (26)]
RXEF010	0.10	0.20	60	40	0.38	0.50	4.0	2.5	4.50	7.50	[0.205mm <sup>2</sup> (24)]
RXEF017	0.17	0.34	60	40	0.48	0.85	3.0	3.3	5.21	8.00	[0.205mm <sup>2</sup> (24)]
<b>RXEF 72V</b>											
RXEF020	0.20	0.40	72	40	0.41	1.00	2.2	1.83	2.75	4.40	[0.205mm <sup>2</sup> (24)]
RXEF025	0.25	0.50	72	40	0.45	1.25	2.5	1.25	1.95	3.00	[0.205mm <sup>2</sup> (24)]
RXEF030	0.30	0.60	72	40	0.49	1.50	3.0	0.88	1.33	2.10	[0.205mm <sup>2</sup> (24)]
RXEF040	0.40	0.80	72	40	0.56	2.00	3.8	0.55	0.86	1.29	[0.205mm <sup>2</sup> (24)]
RXEF050	0.50	1.00	72	40	0.77	2.50	4.0	0.50	0.77	1.17	[0.205mm <sup>2</sup> (24)]
RXEF065	0.65	1.30	72	40	0.88	3.25	5.3	0.31	0.48	0.72	[0.205mm <sup>2</sup> (24)]
RXEF075	0.75	1.50	72	40	0.92	3.75	6.3	0.25	0.40	0.60	[0.205mm <sup>2</sup> (24)]
RXEF090	0.90	1.80	72	40	0.99	4.50	7.2	0.20	0.31	0.47	[0.205mm <sup>2</sup> (24)]
RXEF110	1.10	2.20	72	40	1.50	5.50	8.2	0.15	0.25	0.38	[0.520mm <sup>2</sup> (20)]
RXEF135	1.35	2.70	72	40	1.70	6.75	9.6	0.12	0.19	0.30	[0.520mm <sup>2</sup> (20)]
RXEF160	1.60	3.20	72	40	1.90	8.00	11.4	0.09	0.14	0.22	[0.520mm <sup>2</sup> (20)]
RXEF185	1.85	3.70	72	40	2.10	9.25	12.6	0.08	0.12	0.19	[0.520mm <sup>2</sup> (20)]
RXEF250	2.50	5.00	72	40	2.50	12.50	15.6	0.05	0.08	0.13	[0.520mm <sup>2</sup> (20)]
RXEF300	3.00	6.00	72	40	2.80	15.00	19.8	0.04	0.06	0.10	[0.520mm <sup>2</sup> (20)]
RXEF375	3.75	7.50	72	40	3.20	18.75	24.0	0.03	0.05	0.08	[0.520mm <sup>2</sup> (20)]

**Table R3 Electrical Characteristics for Radial-leaded Devices**

Cont'd

Part Number	I <sub>H</sub> (A)	I <sub>T</sub> (A)	V <sub>MAX</sub> (V)	I <sub>MAX</sub> (A)	P <sub>D Typ</sub> (W)	Max. Time-to-trip		R <sub>MIN</sub> (Ω)	R <sub>MAX</sub> (Ω)	R <sub>1MAX</sub> (Ω)	Lead Size [mm <sup>2</sup> (AWG)]
						(A)	(s)				
<b>RKEF 60V</b>											
RKEF050	0.50	1.00	60	40	1.00	8.00	0.8	0.320	0.529	0.900	[0.205mm <sup>2</sup> (24)]
RKEF065	0.65	1.30	60	40	1.25	8.00	1.0	0.250	0.450	0.720	[0.205mm <sup>2</sup> (24)]
RKEF075	0.75	1.50	60	40	1.40	8.00	1.5	0.200	0.390	0.640	[0.205mm <sup>2</sup> (24)]
RKEF090	0.90	1.80	60	40	1.50	8.00	2.0	0.190	0.320	0.520	[0.205mm <sup>2</sup> (24)]
RKEF110	1.10	2.20	60	40	2.20	8.00	3.0	0.170	0.280	0.470	[0.520mm <sup>2</sup> (20)]
RKEF135	1.35	2.70	60	40	2.30	8.00	4.5	0.110	0.220	0.370	[0.520mm <sup>2</sup> (20)]
RKEF160	1.60	3.20	60	40	2.40	8.20	9.0	0.100	0.200	0.320	[0.520mm <sup>2</sup> (20)]
RKEF185	1.85	3.70	60	40	2.60	9.25	12.6	0.060	0.152	0.250	[0.520mm <sup>2</sup> (20)]
RKEF250	2.50	5.00	60	40	2.80	12.50	15.6	0.040	0.085	0.140	[0.520mm <sup>2</sup> (20)]
RKEF300	3.00	6.00	60	40	3.20	15.00	19.8	0.030	0.050	0.080	[0.520mm <sup>2</sup> (20)]
RKEF375	3.75	7.50	60	40	3.40	18.75	22.0	0.017	0.040	0.060	[0.520mm <sup>2</sup> (20)]
RKEF400	4.00	8.00	60	40	3.70	20.00	24.0	0.014	0.038	0.060	[0.520mm <sup>2</sup> (20)]
RKEF500	5.00	10.00	60	40	5.00	25.00	28.0	0.012	0.030	0.050	[0.520mm <sup>2</sup> (20)]
<b>RUEF 30V</b>											
RUEF090	0.90	1.80	30	100	0.60	4.50	5.9	0.070	0.120	0.22	[0.205mm <sup>2</sup> (24)]
RUEF110	1.10	2.20	30	100	0.70	5.50	6.6	0.070	0.100	0.17	[0.205mm <sup>2</sup> (24)]
RUEF135	1.35	2.70	30	100	0.80	6.75	7.3	0.040	0.080	0.13	[0.205mm <sup>2</sup> (24)]
RUEF160	1.60	3.20	30	100	0.90	8.00	8.0	0.030	0.070	0.11	[0.205mm <sup>2</sup> (24)]
RUEF185	1.85	3.70	30	100	1.00	9.25	8.7	0.030	0.060	0.09	[0.205mm <sup>2</sup> (24)]
RUEF250	2.50	5.00	30	100	1.20	12.50	10.3	0.020	0.040	0.07	[0.205mm <sup>2</sup> (24)]
RUEF300	3.00	6.00	30	100	2.00	15.00	10.8	0.020	0.050	0.08	[0.520mm <sup>2</sup> (20)]
RUEF400	4.00	8.00	30	100	2.50	20.00	12.7	0.010	0.030	0.05	[0.520mm <sup>2</sup> (20)]
RUEF500	5.00	10.00	30	100	3.00	25.00	14.5	0.010	0.030	0.05	[0.520mm <sup>2</sup> (20)]
RUEF600	6.00	12.00	30	100	3.50	30.00	16.0	0.005	0.020	0.04	[0.520mm <sup>2</sup> (20)]
RUEF700	7.00	14.00	30	100	3.80	35.00	17.5	0.005	0.020	0.03	[0.520mm <sup>2</sup> (20)]
RUEF800	8.00	16.00	30	100	4.00	40.00	18.8	0.005	0.013	0.02	[0.520mm <sup>2</sup> (20)]
RUEF900	9.00	18.00	30	100	4.20	45.00	20.0	0.005	0.010	0.02	[0.520mm <sup>2</sup> (20)]
<b>RHEF* 30V - High Temperature</b>											
RHEF050	0.5	0.9	30	40	0.9	2.5	2.5	0.480	0.780	1.10	[0.205mm <sup>2</sup> (24)]
RHEF070	0.7	1.4	30	40	1.4	3.5	3.2	0.300	0.540	0.80	[0.205mm <sup>2</sup> (24)]
RHEF100	1.0	1.8	30	40	1.4	5.0	5.2	0.180	0.300	0.43	[0.205mm <sup>2</sup> (24)]
<b>RUSBF 16V</b>											
RUSBF090	0.90	1.8	16	40	0.6	8.0	1.2	0.070	0.120	0.180	[0.205mm <sup>2</sup> (24)]
RUSBF110	1.10	2.2	16	40	0.7	8.0	2.3	0.050	0.095	0.140	[0.205mm <sup>2</sup> (24)]
RUSBF135	1.35	2.7	16	40	0.8	8.0	4.5	0.040	0.074	0.112	[0.205mm <sup>2</sup> (24)]
RUSBF160	1.60	3.2	16	40	0.9	8.0	9.0	0.030	0.061	0.110	[0.205mm <sup>2</sup> (24)]
RUSBF185	1.85	3.7	16	40	1.0	8.0	10.0	0.030	0.051	0.090	[0.205mm <sup>2</sup> (24)]
RUSBF250	2.50	5.0	16	40	1.2	8.0	40.0	0.020	0.036	0.060	[0.205mm <sup>2</sup> (24)]
<b>RGEF* 16V</b>											
RGEF250	2.5	4.7	16	100	1.0	12.5	5.0	0.0220	0.0350	0.0530	[0.205mm <sup>2</sup> (24)]
RGEF300	3.0	5.1	16	100	2.3	15.0	1.0	0.0380	0.0645	0.0975	[0.520mm <sup>2</sup> (20)]
RGEF400	4.0	6.8	16	100	2.4	20.0	1.7	0.0210	0.0390	0.0600	[0.520mm <sup>2</sup> (20)]
RGEF500	5.0	8.5	16	100	2.6	25.0	2.0	0.0150	0.0240	0.0340	[0.520mm <sup>2</sup> (20)]
RGEF600	6.0	10.2	16	100	2.8	30.0	3.3	0.0100	0.0190	0.0280	[0.520mm <sup>2</sup> (20)]
RGEF700	7.0	11.9	16	100	3.0	35.0	3.5	0.0077	0.0131	0.0200	[0.520mm <sup>2</sup> (20)]
RGEF800	8.0	13.6	16	100	3.0	40.0	5.0	0.0056	0.0110	0.0175	[0.520mm <sup>2</sup> (20)]
RGEF900	9.0	15.3	16	100	3.3	45.0	5.5	0.0047	0.0091	0.0135	[0.520mm <sup>2</sup> (20)]
RGEF1000	10.0	17.0	16	100	3.6	50.0	6.0	0.0040	0.0070	0.0102	[0.520mm <sup>2</sup> (20)]
RGEF1100	11.0	18.7	16	100	3.7	55.0	7.0	0.0037	0.0060	0.0089	[0.520mm <sup>2</sup> (20)]
RGEF1200	12.0	20.4	16	100	4.2	60.0	7.5	0.0033	0.0057	0.0086	[0.823mm <sup>2</sup> (18)]
RGEF1400	14.0	23.8	16	100	4.6	70.0	9.0	0.0026	0.0043	0.0064	[0.823mm <sup>2</sup> (18)]



**Table R3 Electrical Characteristics for Radial-leaded Devices**

Cont'd

Part Number	$I_H$ (A)	$I_T$ (A)	$V_{MAX}$ (V)	$I_{MAX}$ (A)	$P_{D\ TYP}$ (W)	Max. Time-to-trip		$R_{MIN}$ ( $\Omega$ )	$R_{MAX}$ ( $\Omega$ )	$R_{1MAX}$ ( $\Omega$ )	Lead Size [mm <sup>2</sup> (AWG)]
						(A)	(s)				
<b>RHEF*</b>											
<b>16V - High Temperature</b>											
RHEF200	2.0	3.8	16	100	1.4	10.0	4.3	0.0450	0.07400	0.1100	[0.205mm <sup>2</sup> (24)]
RHEF300	3.0	6.0	16	100	3.0	15.0	5.0	0.0330	0.05300	0.0790	[0.520mm <sup>2</sup> (20)]
RHEF400	4.0	7.5	16	100	3.3	20.0	5.0	0.0240	0.04000	0.0600	[0.520mm <sup>2</sup> (20)]
RHEF450	4.5	7.8	16	100	3.6	22.5	3.0	0.0220	0.03600	0.0540	[0.520mm <sup>2</sup> (20)]
RHEF550	5.5	10.0	16	100	3.5	27.5	6.0	0.0150	0.02500	0.0370	[0.520mm <sup>2</sup> (20)]
RHEF600	6.0	10.8	16	100	4.1	30.0	5.0	0.0130	0.02150	0.0320	[0.520mm <sup>2</sup> (20)]
RHEF650	6.5	12.0	16	100	4.1	32.5	5.5	0.0110	0.01750	0.0260	[0.520mm <sup>2</sup> (20)]
RHEF700	7.0	13.0	16	100	4.0	35.0	7.0	0.0100	0.01640	0.0250	[0.520mm <sup>2</sup> (20)]
RHEF750	7.5	13.1	16	100	4.5	37.5	7.0	0.0094	0.01530	0.0220	[0.520mm <sup>2</sup> (20)]
RHEF800	8.0	15.0	16	100	4.2	40.0	8.0	0.0080	0.01350	0.0200	[0.520mm <sup>2</sup> (20)]
RHEF900	9.0	16.5	16	100	5.0	45.0	10.0	0.0074	0.01200	0.0170	[0.520mm <sup>2</sup> (20)]
RHEF1000	10.0	18.5	16	100	5.3	50.0	9.0	0.0062	0.01050	0.0150	[0.520mm <sup>2</sup> (20)]
RHEF1100	11.0	20.0	16	100	5.5	55.0	11.0	0.0055	0.00900	0.0130	[0.520mm <sup>2</sup> (20)]
RHEF1300	13.0	24.0	16	100	6.9	65.0	13.0	0.0041	0.00690	0.0100	[0.823mm <sup>2</sup> (18)]
RHEF1400	14.0	27.0	16	100	6.9	70.0	13.0	0.0030	0.00600	0.0090	[0.823mm <sup>2</sup> (18)]
RHEF1500	15.0	28.0	16	100	7.0	75.0	20.0	0.0032	0.00613	0.0092	[0.823mm <sup>2</sup> (18)]
<b>RUSBF</b>											
<b>6V</b>											
RUSBF075	0.75	1.30	6	40	0.3	8.0	0.4	0.110	0.1750	0.23	[0.205mm <sup>2</sup> (24)]
RUSBF120	1.20	2.00	6	40	0.6	8.0	0.5	0.070	0.0975	0.14	[0.205mm <sup>2</sup> (24)]
RUSBF155	1.55	2.65	6	40	0.6	7.8	2.2	0.040	0.0705	0.10	[0.205mm <sup>2</sup> (24)]

**Notes:**

- $I_H$  : Hold current: maximum current device will pass without interruption in 20°C still air.
  - $I_T$  : Trip current: minimum current that will switch the device from low resistance to high resistance in 20°C still air.
  - $V_{MAX}$  : Maximum continuous voltage device can withstand without damage at rated current.
  - $I_{MAX}$  : Maximum fault current device can withstand without damage at rated voltage.
  - $P_D$  : Power dissipated from device when in the tripped state in 20°C still air.
  - $R_{MIN}$  : Minimum resistance of device as supplied at 20°C unless otherwise specified.
  - $R_{MAX}$  : Maximum resistance of device as supplied at 20°C unless otherwise specified.
  - $R_{1MAX}$  : Maximum resistance of device when measured one hour post reflow (surface-mount device) or one hour post trip (radial-leaded device) at 20°C unless otherwise specified.
- \* Electrical characteristics determined at 25°C.

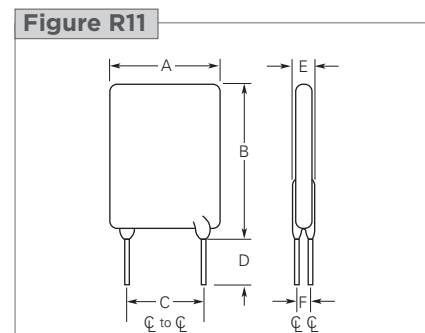
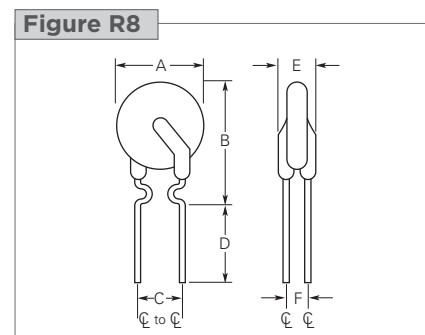
**Figure R6-R14 Dimension Figures for Radial-leaded Devices**

**Figure R12**

**Figure R13**

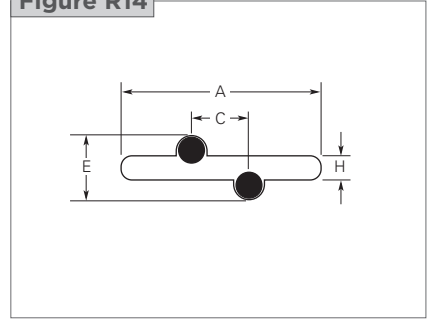
**Figure R14**

**Table R4 Dimensions & Weights for Radial-leaded Devices**

Part Number	Dimensions in Millimeters (Inches)												Figure	Device Mass (g) (Only for reference)	
	A		B		C		D		E		F	H			J
	Min.	Max.	Min.	Max.	Min.	Max.	Min.	Max.	Min.	Max.	Typ.	Typ.			Typ.
<b>BBRF</b>															
<b>99V</b>															
BBRF550	—	10.9 (0.43)	—	14.0 (0.55)	4.3 (0.17)	5.8 (0.23)	7.6 (0.3)	—	—	3.6 (0.14)	—	1.37 (0.054)	1.2 (0.05)	R6, R13, R14	0.534
<b>RXEF</b>															
<b>60V</b>															
RXEF005	—	8.0 (0.32)	—	8.3 (0.33)	4.3 (0.17)	5.8 (0.23)	7.6 (0.30)	—	—	3.0 (0.12)	—	1.07 (0.042)	1.0 (0.04)	R7, R13, R14	0.069
RXEF010	—	7.4 (0.29)	—	11.6 (0.46)	4.3 (0.17)	5.8 (0.23)	7.6 (0.30)	—	—	3.0 (0.12)	—	1.07 (0.042)	1.0 (0.04)	R7, R13, R14	0.128
RXEF017	—	7.4 (0.29)	—	12.7 (0.50)	4.3 (0.17)	5.8 (0.23)	7.6 (0.30)	—	—	3.0 (0.12)	—	1.68 (0.066)	1.7 (0.07)	R7, R13, R14	0.174
<b>RXEF</b>															
<b>72V</b>															
RXEF020	—	7.4 (0.29)	—	11.7 (0.46)	4.3 (0.17)	5.8 (0.23)	7.6 (0.30)	—	—	3.0 (0.12)	—	1.17 (0.046)	1.0 (0.04)	R8, R13, R14	0.119
RXEF025	—	7.4 (0.29)	—	12.7 (0.50)	4.3 (0.17)	5.8 (0.23)	7.6 (0.30)	—	—	3.0 (0.12)	—	1.17 (0.046)	1.0 (0.04)	R8, R13, R14	0.130
RXEF030	—	7.4 (0.29)	—	12.7 (0.50)	4.3 (0.17)	5.8 (0.23)	7.6 (0.30)	—	—	3.0 (0.12)	—	1.17 (0.046)	1.0 (0.04)	R8, R13, R14	0.143
RXEF040	—	7.6 (0.30)	—	13.5 (0.53)	4.3 (0.17)	5.8 (0.23)	7.6 (0.30)	—	—	3.0 (0.12)	—	1.17 (0.046)	1.2 (0.05)	R8, R13, R14	0.202
RXEF050	—	7.9 (0.31)	—	13.7 (0.54)	4.3 (0.17)	5.8 (0.23)	7.6 (0.30)	—	—	3.0 (0.12)	—	1.17 (0.046)	1.2 (0.05)	R8, R13, R14	0.210
RXEF065	—	9.4 (0.37)	—	14.5 (0.57)	4.3 (0.17)	5.8 (0.23)	7.6 (0.30)	—	—	3.0 (0.12)	—	1.17 (0.046)	1.5 (0.06)	R8, R13, R14	0.277
RXEF075	—	10.2 (0.40)	—	15.2 (0.60)	4.3 (0.17)	5.8 (0.23)	7.6 (0.30)	—	—	3.0 (0.12)	—	1.17 (0.046)	1.5 (0.06)	R8, R13, R14	0.310
RXEF090	—	11.2 (0.44)	—	15.8 (0.62)	4.3 (0.17)	5.8 (0.23)	7.6 (0.30)	—	—	3.0 (0.12)	—	1.17 (0.046)	1.5 (0.06)	R8, R13, R14	0.365
RXEF110	—	12.8 (0.50)	—	17.5 (0.69)	4.3 (0.17)	5.8 (0.23)	7.6 (0.30)	—	—	3.0 (0.12)	—	1.37 (0.054)	1.2 (0.05)	R9, R13, R14	0.546
RXEF135	—	14.5 (0.57)	—	19.1 (0.75)	4.3 (0.17)	5.8 (0.23)	7.6 (0.30)	—	—	3.0 (0.12)	—	1.37 (0.054)	1.2 (0.05)	R9, R13, R14	0.653
RXEF160	—	16.3 (0.64)	—	20.8 (0.82)	4.3 (0.17)	5.8 (0.23)	7.6 (0.30)	—	—	3.0 (0.12)	—	1.37 (0.054)	1.5 (0.06)	R9, R13, R14	0.684
RXEF185	—	17.5 (0.69)	—	22.4 (0.88)	4.3 (0.17)	5.8 (0.23)	7.6 (0.30)	—	—	3.0 (0.12)	—	1.37 (0.054)	1.5 (0.06)	R9, R13, R14	0.808
RXEF250	—	20.8 (0.82)	—	25.4 (1.00)	9.4 (0.37)	10.9 (0.43)	7.6 (0.30)	—	—	3.0 (0.12)	—	1.37 (0.054)	1.7 (0.07)	R9, R13, R14	1.139
RXEF300	—	23.9 (0.94)	—	28.6 (1.13)	9.4 (0.37)	10.9 (0.43)	7.6 (0.30)	—	—	3.0 (0.12)	—	1.37 (0.054)	1.7 (0.07)	R9, R13, R14	1.379
RXEF375	—	27.2 (1.07)	—	31.8 (1.25)	9.4 (0.37)	10.9 (0.43)	7.6 (0.30)	—	—	3.0 (0.12)	—	1.37 (0.054)	1.7 (0.07)	R9, R13, R14	1.708

**Table R4 Dimensions & Weights for Radial-leaded Devices**

Cont'd

Part Number	Dimensions in Millimeters (Inches)												Figure	Device Mass (g) (Only for reference)	
	A		B		C		D		E		F	H			J
	Min.	Max.	Min.	Max.	Min.	Max.	Min.	Max.	Min.	Max.	Typ.	Typ.			Typ.
<b>RKEF</b>															
<b>60V</b>															
RKEF050	—	7.10 (0.28)	—	11.43 (0.45)	4.32 (0.17)	5.84 (0.23)	7.60 (0.30)	—	—	3.56 (0.14)	—	—	—	R10, R13, R14	0.166
RKEF065	—	7.11 (0.28)	—	12.20 (0.48)	4.32 (0.17)	5.84 (0.23)	7.60 (0.30)	—	—	3.56 (0.14)	—	—	—	R10, R13, R14	0.182
RKEF075	—	7.87 (0.31)	—	12.20 (0.48)	4.32 (0.17)	5.84 (0.23)	7.60 (0.30)	—	—	3.56 (0.14)	—	—	—	R10, R13, R14	0.201
RKEF090	—	7.87 (0.31)	—	13.97 (0.55)	4.32 (0.17)	5.84 (0.23)	7.60 (0.30)	—	—	3.56 (0.14)	—	—	—	R10, R13, R14	0.235
RKEF110	—	7.60 (0.30)	—	15.00 (0.59)	4.32 (0.17)	5.84 (0.23)	7.60 (0.30)	—	—	4.10 (0.16)	—	—	—	R10, R13, R14	0.353
RKEF135	—	10.20 (0.40)	—	17.00 (0.67)	4.32 (0.17)	5.84 (0.23)	7.60 (0.30)	—	—	3.81 (0.15)	—	—	—	R11, R13, R14	0.438
RKEF160	—	12.20 (0.48)	—	18.30 (0.72)	4.32 (0.17)	5.84 (0.23)	7.60 (0.30)	—	—	3.81 (0.15)	—	—	—	R11, R13, R14	0.546
RKEF185	—	13.00 (0.51)	—	18.80 (0.74)	4.32 (0.17)	5.84 (0.23)	7.60 (0.30)	—	—	3.81 (0.15)	—	—	—	R11, R13, R14	0.538
RKEF250	—	14.00 (0.55)	—	20.60 (0.81)	4.32 (0.17)	5.84 (0.23)	7.60 (0.30)	—	—	3.00 (0.12)	—	—	—	R11, R13, R14	0.775
RKEF300	—	16.50 (0.65)	—	21.20 (0.83)	4.32 (0.17)	5.84 (0.23)	7.60 (0.30)	—	—	3.00 (0.12)	—	—	—	R11, R13, R14	0.971
RKEF375	—	16.50 (0.65)	—	25.20 (0.99)	9.40 (0.37)	10.90 (0.43)	7.60 (0.30)	—	—	3.00 (0.12)	—	—	—	R11, R13, R14	1.142
RKEF400	—	21.00 (0.83)	—	24.90 (0.98)	9.40 (0.37)	10.90 (0.43)	7.60 (0.30)	—	—	3.00 (0.12)	—	—	—	R11, R13, R14	1.391
RKEF500	—	24.10 (0.95)	—	29.00 (1.14)	9.40 (0.37)	10.90 (0.43)	7.60 (0.30)	—	—	3.00 (0.12)	—	—	—	R11, R13, R14	1.783
<b>RUEF</b>															
<b>30V</b>															
RUEF090	—	7.4 (0.29)	—	12.2 (0.48)	4.3 (0.17)	5.8 (0.23)	7.6 (0.30)	—	—	3.0 (0.12)	—	0.89 (0.035)	0.8 (0.03)	R10, R13, R14	0.183
RUEF110	—	7.4 (0.29)	—	14.2 (0.56)	4.3 (0.17)	5.8 (0.23)	7.6 (0.30)	—	—	3.0 (0.12)	—	0.89 (0.035)	0.8 (0.03)	R10, R13, R14	0.204
RUEF135	—	8.9 (0.35)	—	13.5 (0.53)	4.3 (0.17)	5.8 (0.23)	7.6 (0.30)	—	—	3.0 (0.12)	—	0.89 (0.035)	1.0 (0.04)	R10, R13, R14	0.255
RUEF160	—	8.9 (0.35)	—	15.2 (0.60)	4.3 (0.17)	5.8 (0.23)	7.6 (0.30)	—	—	3.0 (0.12)	—	0.89 (0.035)	1.0 (0.04)	R10, R13, R14	0.289
RUEF185	—	10.2 (0.40)	—	15.7 (0.62)	4.3 (0.17)	5.8 (0.23)	7.6 (0.30)	—	—	3.0 (0.12)	—	0.89 (0.035)	1.0 (0.04)	R10, R13, R14	0.379
RUEF250	—	11.4 (0.45)	—	18.3 (0.72)	4.3 (0.17)	5.8 (0.23)	7.6 (0.30)	—	—	3.0 (0.12)	—	0.89 (0.035)	1.2 (0.05)	R10, R13, R14	0.493
RUEF300	—	11.4 (0.45)	—	16.5 (0.65)	4.3 (0.17)	5.8 (0.23)	7.6 (0.30)	—	—	3.0 (0.12)	—	1.19 (0.047)	1.5 (0.06)	R11, R13, R14	0.516
RUEF400	—	14.0 (0.55)	—	19.3 (0.76)	4.3 (0.17)	5.8 (0.23)	7.6 (0.30)	—	—	3.0 (0.12)	—	1.19 (0.047)	1.7 (0.07)	R11, R13, R14	0.670
RUEF500	—	14.0 (0.55)	—	24.1 (0.95)	9.4 (0.37)	10.9 (0.43)	7.6 (0.30)	—	—	3.0 (0.12)	—	1.19 (0.047)	1.0 (0.04)	R11, R13, R14	0.926
RUEF600	—	16.5 (0.65)	—	24.1 (0.95)	9.4 (0.37)	10.9 (0.43)	7.6 (0.30)	—	—	3.0 (0.12)	—	1.19 (0.047)	1.0 (0.04)	R11, R13, R14	1.352
RUEF700	—	19.1 (0.75)	—	25.9 (1.02)	9.4 (0.37)	10.9 (0.43)	7.6 (0.30)	—	—	3.0 (0.12)	—	1.19 (0.047)	1.2 (0.05)	R11, R13, R14	1.543
RUEF800	—	21.6 (0.85)	—	28.4 (1.12)	9.4 (0.37)	10.9 (0.43)	7.6 (0.30)	—	—	3.0 (0.12)	—	1.19 (0.047)	1.5 (0.06)	R11, R13, R14	1.852
RUEF900	—	24.1 (0.95)	—	29.0 (1.14)	9.4 (0.37)	10.9 (0.43)	7.6 (0.30)	—	—	3.0 (0.12)	—	1.19 (0.047)	1.5 (0.06)	R11, R13, R14	2.104
<b>RHEF</b>															
<b>30V - High Temperature</b>															
RHEF050	—	7.4 (0.29)	—	12.7 (0.50)	4.3 (0.17)	5.8 (0.23)	7.6 (0.30)	—	—	3.0 (0.12)	1.2 (0.05)	—	—	R8, R13, R14	0.177
RHEF070	—	6.9 (0.27)	—	10.8 (0.43)	4.3 (0.17)	5.8 (0.23)	7.6 (0.30)	—	—	3.0 (0.12)	1.2 (0.05)	1.24 (0.049)	1.2 (0.05)	R10, R13, R14	0.259
RHEF100	—	9.7 (0.38)	—	13.6 (0.54)	4.3 (0.17)	5.8 (0.23)	7.6 (0.30)	—	—	3.0 (0.12)	—	—	—	R8, R13, R14	0.312

**Table R4 Dimensions & Weights for Radial-leaded Devices**

Cont'd

Part Number	Dimensions in Millimeters (Inches)												Figure	Device Mass (g) (Only for reference)	
	A		B		C		D		E		F	H			J
	Min.	Max.	Min.	Max.	Min.	Max.	Min.	Max.	Min.	Max.	Typ.	Typ.			Typ.
<b>RUSBF</b>															
<b>16V</b>															
RUSBF090	—	7.4 (0.29)	—	12.2 (0.48)	4.3 (0.17)	5.8 (0.23)	7.6 (0.30)	—	—	3.1 (0.12)	—	0.89 (0.035)	0.8 (0.03)	R10, R13, R14	0.183
RUSBF110	—	7.4 (0.29)	—	14.2 (0.56)	4.3 (0.17)	5.8 (0.23)	7.6 (0.30)	—	—	3.0 (0.12)	—	0.89 (0.035)	0.8 (0.03)	R10, R13, R14	0.204
RUSBF135	—	8.9 (0.35)	—	13.5 (0.53)	4.3 (0.17)	5.8 (0.23)	7.6 (0.30)	—	—	3.0 (0.12)	—	0.89 (0.035)	1.0 (0.04)	R10, R13, R14	0.240
RUSBF160	—	8.9 (0.35)	—	15.2 (0.60)	4.3 (0.17)	5.8 (0.23)	7.6 (0.30)	—	—	3.0 (0.12)	—	0.89 (0.035)	1.0 (0.04)	R10, R13, R14	0.300
RUSBF185	—	10.2 (0.40)	—	15.7 (0.62)	4.3 (0.17)	5.8 (0.23)	7.6 (0.30)	—	—	3.0 (0.12)	—	0.89 (0.035)	1.0 (0.04)	R10, R13, R14	0.368
RUSBF250	—	11.4 (0.45)	—	18.3 (0.72)	4.3 (0.17)	5.8 (0.23)	7.6 (0.30)	—	—	3.0 (0.12)	—	0.89 (0.035)	1.2 (0.05)	R10, R13, R14	0.467
<b>RGEF</b>															
<b>16V</b>															
RGEF250	—	8.9 (0.35)	—	12.8 (0.50)	4.3 (0.17)	5.8 (0.23)	3.18 (0.13)	6.18 (0.24)	—	3.0 (0.12)	1.2 (0.05)	1.24 (0.049)	1.2 (0.05)	R10, R13, R14	0.277
RGEF300	6.1 (0.24)	7.1 (0.28)	6.1 (0.24)	11.0 (0.43)	4.3 (0.17)	5.8 (0.23)	7.6 (0.30)	—	2.0 (0.08)	3.0 (0.12)	1.2 (0.05)	1.24 (0.049)	1.2 (0.05)	R11, R13, R14	0.323
RGEF400	7.9 (0.31)	8.9 (0.35)	7.9 (0.31)	12.8 (0.50)	4.3 (0.17)	5.8 (0.23)	7.6 (0.30)	—	2.0 (0.08)	3.0 (0.12)	1.2 (0.05)	1.24 (0.049)	1.4 (0.06)	R11, R13, R14	0.417
RGEF500	9.4 (0.37)	10.4 (0.41)	9.4 (0.37)	14.3 (0.56)	4.3 (0.17)	5.8 (0.23)	7.6 (0.30)	—	2.0 (0.08)	3.0 (0.12)	1.2 (0.05)	1.24 (0.049)	1.6 (0.06)	R11, R13, R14	0.540
RGEF600	9.7 (0.38)	10.7 (0.42)	12.2 (0.48)	17.1 (0.67)	4.3 (0.17)	5.8 (0.23)	7.6 (0.30)	—	2.0 (0.08)	3.0 (0.12)	1.2 (0.05)	1.24 (0.049)	1.6 (0.06)	R11, R13, R14	0.604
RGEF700	10.2 (0.40)	11.2 (0.44)	14.7 (0.58)	19.7 (0.78)	4.3 (0.17)	5.8 (0.23)	7.6 (0.30)	—	2.0 (0.08)	3.0 (0.12)	1.2 (0.05)	1.24 (0.049)	1.7 (0.07)	R11, R13, R14	0.701
RGEF800	11.7 (0.46)	12.7 (0.50)	16.0 (0.63)	20.9 (0.82)	4.3 (0.17)	5.8 (0.23)	7.6 (0.30)	—	2.0 (0.08)	3.0 (0.12)	1.2 (0.05)	1.24 (0.049)	1.8 (0.07)	R11, R13, R14	0.829
RGEF900	13.0 (0.51)	14.0 (0.55)	16.8 (0.66)	21.7 (0.85)	4.3 (0.17)	5.8 (0.23)	7.6 (0.30)	—	2.0 (0.08)	3.0 (0.12)	1.2 (0.05)	1.24 (0.049)	2.0 (0.08)	R11, R13, R14	0.887
RGEF1000	15.5 (0.61)	16.5 (0.65)	21.1 (0.83)	25.2 (0.99)	4.3 (0.17)	5.8 (0.23)	7.6 (0.30)	—	2.0 (0.08)	3.0 (0.12)	1.2 (0.05)	1.24 (0.049)	2.0 (0.08)	R11, R13, R14	1.219
RGEF1100	16.5 (0.65)	17.5 (0.69)	21.1 (0.83)	26.0 (1.02)	4.3 (0.17)	5.8 (0.23)	7.6 (0.30)	—	2.0 (0.08)	3.0 (0.12)	1.2 (0.05)	1.24 (0.049)	2.4 (0.09)	R11, R13, R14	1.408
RGEF1200	16.4 (0.65)	17.5 (0.69)	22.6 (0.89)	28.0 (1.10)	9.4 (0.37)	10.9 (0.43)	7.6 (0.30)	—	2.3 (0.09)	3.5 (0.14)	1.4 (0.06)	1.45 (0.057)	1.5 (0.06)	R11, R13, R14	1.650
RGEF1400	22.4 (0.88)	23.5 (0.925)	22.6 (0.89)	27.9 (1.10)	9.4 (0.37)	10.9 (0.43)	7.6 (0.30)	—	2.3 (0.09)	3.5 (0.14)	1.4 (0.06)	1.45 (0.057)	1.9 (0.08)	R11, R13, R14	2.146
<b>RHEF</b>															
<b>16V - High Temperature</b>															
RHEF200	—	9.4 (0.37)	—	14.4 (0.57)	4.3 (0.17)	5.8 (0.23)	7.6 (0.30)	—	—	3.1 (0.12)	—	—	—	R8, R13, R14	0.278
RHEF300	—	8.8 (0.35)	—	13.8 (0.55)	4.3 (0.17)	5.8 (0.23)	7.6 (0.30)	—	—	3.0 (0.12)	1.2 (0.05)	—	—	R12, R13, R14	0.433
RHEF400	—	10.0 (0.39)	—	15.0 (0.59)	4.3 (0.17)	5.8 (0.23)	7.6 (0.30)	—	—	3.0 (0.12)	1.2 (0.05)	1.24 (0.049)	1.6 (0.06)	R12, R13, R14	0.509
RHEF450	—	10.4 (0.41)	—	15.6 (0.61)	4.3 (0.17)	5.8 (0.23)	7.6 (0.30)	—	—	3.0 (0.12)	1.2 (0.05)	1.24 (0.049)	1.6 (0.06)	R12, R13, R14	0.605
RHEF550	—	11.2 (0.44)	—	18.9 (0.74)	4.3 (0.17)	5.8 (0.23)	7.6 (0.30)	—	—	3.0 (0.12)	1.2 (0.05)	—	—	R12, R13, R14	0.704
RHEF600	—	11.2 (0.44)	—	21.0 (0.83)	4.3 (0.17)	5.8 (0.23)	7.6 (0.30)	—	—	3.0 (0.12)	1.2 (0.05)	1.24 (0.049)	1.7 (0.067)	R12, R13, R14	0.792
RHEF650	—	12.7 (0.50)	—	22.2 (0.88)	4.3 (0.17)	5.8 (0.23)	7.6 (0.30)	—	—	3.0 (0.12)	1.2 (0.05)	1.24 (0.049)	1.8 (0.07)	R12, R13, R14	0.952
RHEF700	—	14.0 (0.55)	—	21.9 (0.86)	4.3 (0.17)	5.8 (0.23)	7.6 (0.30)	—	—	3.0 (0.12)	1.2 (0.05)	—	—	R12, R13, R14	0.850
RHEF750	—	14.0 (0.55)	—	23.5 (0.93)	4.3 (0.17)	5.8 (0.23)	7.6 (0.30)	—	—	3.0 (0.12)	1.2 (0.05)	1.24 (0.049)	2.0 (0.08)	R12, R13, R14	1.054
RHEF800	—	16.5 (0.65)	—	22.5 (0.88)	4.3 (0.17)	5.8 (0.23)	7.6 (0.30)	—	—	3.0 (0.12)	1.2 (0.05)	—	—	R12, R13, R14	1.073
RHEF900	—	16.5 (0.65)	—	25.7 (1.01)	4.3 (0.17)	5.8 (0.23)	7.6 (0.30)	—	—	3.0 (0.12)	1.2 (0.05)	—	—	R12, R13, R14	1.516

12

**Table R4 Dimensions & Weights for Radial-leaded Devices**

Cont'd

Part Number	Dimensions in Millimeters (Inches)												Figure	Device Mass (g) (Only for reference)	
	A		B		C		D		E		F	H			J
	Min.	Max.	Min.	Max.	Min.	Max.	Min.	Max.	Min.	Max.	Typ.	Typ.			Typ.
<b>RHEF</b>															
<b>16V - High Temperature</b>															
RHEF1000	—	17.5 (0.69)	—	26.5 (1.04)	9.4 (0.37)	10.9 (0.43)	7.6 (0.30)	—	—	3.0 (0.12)	1.2 (0.05)	1.24 (0.049)	1.5 (0.06)	R12, R13, R14	1.791
RHEF1100	—	21.0 (0.83)	—	26.1 (1.03)	9.4 (0.37)	10.9 (0.43)	7.6 (0.30)	—	—	3.0 (0.12)	1.2 (0.05)	—	—	R12, R13, R14	1.570
RHEF1300	—	23.5 (0.925)	—	28.7 (1.13)	9.4 (0.37)	10.9 (0.43)	7.6 (0.30)	—	—	3.6 (0.14)	1.4 (0.06)	1.45 (0.057)	1.9 (0.084)	R12, R13, R14	2.257
RHEF1400	—	23.5 (0.925)	—	28.6 (1.13)	9.4 (0.37)	10.9 (0.43)	7.6 (0.30)	—	—	3.6 (0.14)	1.4 (0.06)	—	—	R12, R13, R14	2.051
RHEF1500	—	23.5 (0.925)	—	28.7 (1.13)	9.4 (0.37)	10.9 (0.43)	7.6 (0.30)	—	—	3.6 (0.14)	1.4 (0.06)	1.45 (0.057)	1.9 (0.084)	R12, R13, R14	2.257
<b>RUSBF</b>															
<b>6V</b>															
RUSBF075	—	6.9 (0.27)	—	11.4 (0.45)	4.3 (0.17)	5.9 (0.23)	7.6 (0.30)	—	—	3.1 (0.12)	—	0.91 (0.036)	1.0 (0.04)	R8, R13, R14	0.123
RUSBF120	—	6.9 (0.27)	—	11.7 (0.46)	4.3 (0.17)	5.9 (0.23)	7.6 (0.30)	—	—	3.1 (0.12)	—	0.91 (0.036)	1.0 (0.04)	R8, R13, R14	0.111
RUSBF155	—	6.9 (0.27)	—	11.7 (0.46)	4.3 (0.17)	5.9 (0.23)	7.6 (0.30)	—	—	3.1 (0.12)	—	0.91 (0.036)	1.0 (0.04)	R8, R13, R14	0.135

**Figure R15-R21 Typical Time-to-trip Curves at 20°C for Radial-leaded Devices**
**BBRF**

A = BBRF550

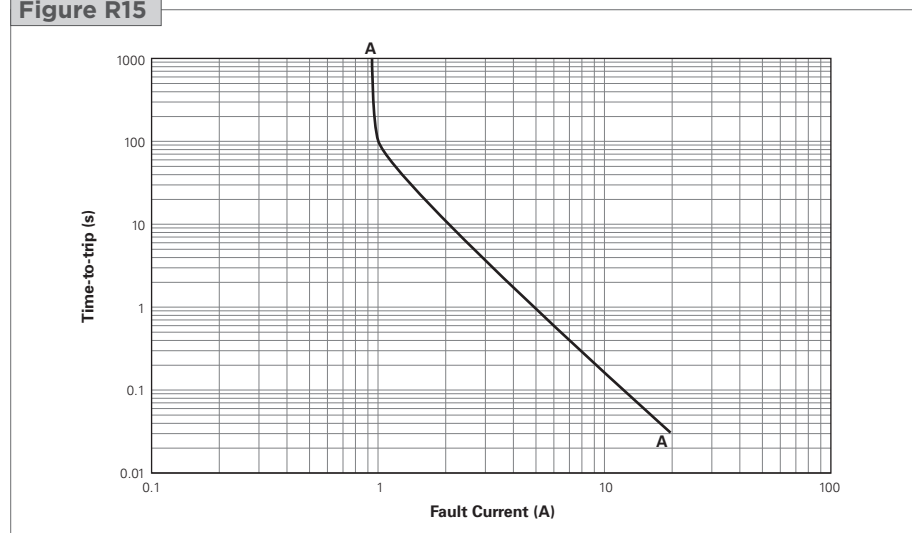
**Figure R15**

**RXEF**

- |             |             |
|-------------|-------------|
| A = RXEF005 | J = RXEF075 |
| B = RXEF010 | K = RXEF090 |
| C = RXEF017 | L = RXEF110 |
| D = RXEF020 | M = RXEF135 |
| E = RXEF025 | N = RXEF160 |
| F = RXEF030 | O = RXEF185 |
| G = RXEF040 | P = RXEF250 |
| H = RXEF050 | Q = RXEF300 |
| I = RXEF065 | R = RXEF375 |

**Figure R16**



**RKEF**

- |             |             |
|-------------|-------------|
| A = RKEF050 | J = RKEF300 |
| B = RKEF065 | K = RKEF375 |
| C = RKEF075 | L = RKEF400 |
| D = RKEF090 | M = RKEF500 |
| E = RKEF110 |             |
| F = RKEF135 |             |
| G = RKEF160 |             |
| H = RKEF185 |             |
| I = RKEF250 |             |

**Figure R17**

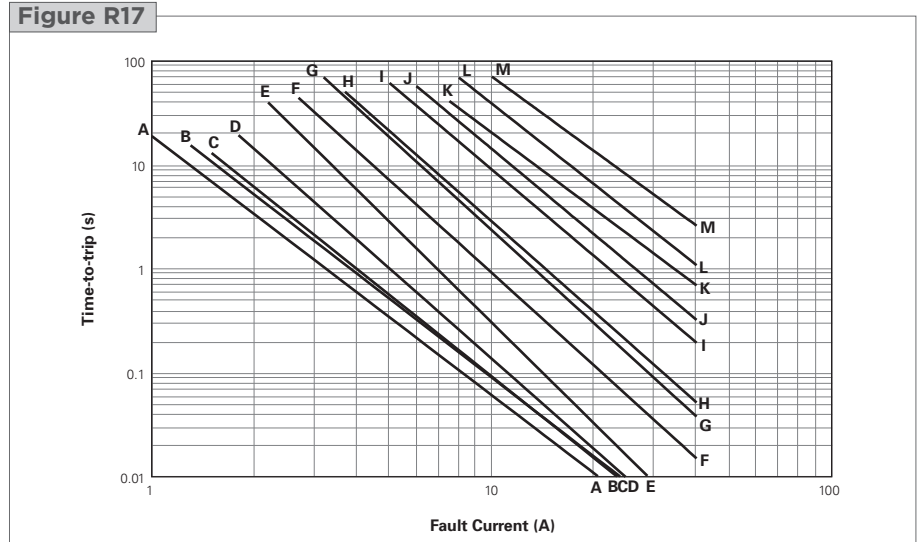

**RUEF**

- |             |             |
|-------------|-------------|
| A = RUEF090 | H = RUEF400 |
| B = RUEF110 | I = RUEF500 |
| C = RUEF135 | J = RUEF600 |
| D = RUEF160 | K = RUEF700 |
| E = RUEF185 | L = RUEF800 |
| F = RUEF250 | M = RUEF900 |
| G = RUEF300 |             |

**Figure R18**

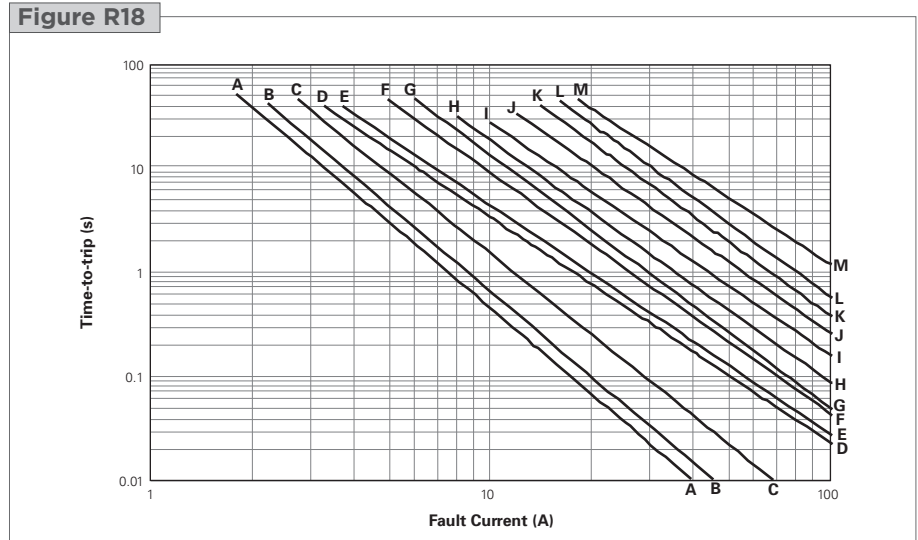

**Figure R15-R21 Typical Time-to-trip Curves at 20°C for Radial-leaded Devices**

Cont'd

**RGEF (data at 25°C)**

- A = RGEF250
- B = RGEF300
- C = RGEF400
- D = RGEF500
- E = RGEF600
- F = RGEF700
- G = RGEF800
- H = RGEF900
- I = RGEF1000
- J = RGEF1100
- K = RGEF1200
- L = RGEF1400

**Figure R19**

**RHEF (data at 25°C)**

- A = RHEF050
- B = RHEF070
- C = RHEF100
- D = RHEF200
- E = RHEF300
- F = RHEF400
- G = RHEF450
- H = RHEF550
- I = RHEF600
- J = RHEF650
- K = RHEF700
- L = RHEF750
- M = RHEF800
- N = RHEF900
- O = RHEF1000
- P = RHEF1100
- Q = RHEF1300
- R = RHEF1400
- S = RHEF1500

**Figure R20**

**RUSBF**

- A = RUSBF075
- B = RUSBF090
- C = RUSBF110
- D = RUSBF120
- E = RUSBF135
- F = RUSBF155
- G = RUSBF160
- H = RUSBF185
- I = RUSBF250

**Figure R21**

**Table R5 Physical Characteristics and Environmental Specifications for Radial-leaded Devices**
**BBRF**
**Physical Characteristics**

Lead material	Tin-plated copper, 0.52mm <sup>2</sup> (20AWG), ø0.81mm (0.032in.)
Soldering characteristics	Solderability per ANSI/J-STD-002 Category 3
Solder heat withstand	per IEC-STD 68-2-20, Test Tb, Method 1A, Condition B, can withstand 10 seconds at 260°C ±5°C
Insulating material	Cured, flame-retardant epoxy polymer; meets UL 94V-0
Operation temperature	-40°C~85°C

**Note:** Devices are not designed to be placed through a reflow process.

**Environmental Specifications**

Test	Conditions	Resistance Change
Passive aging	70°C, 1000 hours	±5%
	85°C, 1000 hours	±5%
Humidity aging	85°C, 85%RH, 1000 hours	±5%
Thermal shock	85°C, -40°C (10 times)	±5%
Solvent resistance	MIL-STD-202, Method 215F	No change

**RXEF**
**Physical Characteristics**

Lead material	RXEF005 : Tin-plated nickel-copper alloy, 0.128mm <sup>2</sup> (26AWG), ø0.40mm (0.016in.)
	RXEF010 : Tin-plated nickel-copper alloy, 0.205mm <sup>2</sup> (24AWG), ø0.51mm (0.020in.)
	RXEF017 to 040 : Tin-plated copper-clad steel, 0.205mm <sup>2</sup> (24AWG), ø0.51mm (0.020in.)
	RXEF050 to 090 : Tin-plated copper, 0.205mm <sup>2</sup> (24AWG), ø0.51mm (0.020in.)
	RXEF110 to 375 : Tin-plated copper, 0.52mm <sup>2</sup> (20AWG), ø0.81mm (0.032in.)
Soldering characteristics	Solderability per ANSI/J-STD-002 Category 3
	RXEF005, RXEF010 meet ANSI/J-STD-002 Category 1
Solder heat withstand	RXEF005- RXEF025: per IEC-STD 68-2-20, Test Tb, Method 1a, condition a; can withstand 5 seconds at 260°C ±5°C
	All other sizes: per IEC-STD 68-2-20, Test Tb, Method 1a, condition b; can withstand 10 seconds at 260°C ±5°C
Insulating material	Cured, flame-retardant epoxy polymer; meets UL 94V-0
Operation temperature	-40°C~85°C

**Note:** Devices are not designed to be placed through a reflow process.

**Environmental Specifications**

Test	Conditions	Resistance Change
Passive aging	-40°C, 1000 hours	±5%
	85°C, 1000 hours	±5%
Humidity aging	85°C, 85%RH, 1000 hours	±10%
Thermal shock	85°C, -40°C (10 times)	±10%
Solvent resistance	MIL-STD-202, Method 215F	No change

**RKEF**
**Physical Characteristics**

Lead material	RKEF050 to 090 : Tin-plated copper, 0.205mm <sup>2</sup> (24AWG), ø0.51mm (0.020in.)
	RKEF110 to 500 : Tin-plated copper, 0.52mm <sup>2</sup> (20AWG), ø0.81mm (0.032in.)
Soldering characteristics	Solderability per ANSI/J-STD-002 Category 3
Solder heat withstand	RKEF050-RKEF185 : per IEC-STD 68-2-20, Test Tb, Method 1a, condition a; can withstand 5 seconds at 260°C ±5°C
	All other sizes: per IEC-STD 68-2-20, Test Tb, Method 1a, condition b; RKEF can withstand 10 seconds at 260°C ±5°C
Insulating material	Cured, flame-retardant epoxy polymer; meets UL 94V-0
Operation temperature	-40°C~85°C

**Note:** Devices are not designed to be placed through a reflow process.



**Table R5 Physical Characteristics and Environmental Specifications for Radial-leaded Devices**

Cont'd

**RKEF**
**Environmental Specifications**

Test	Conditions	Resistance Change
Passive aging	-40°C, 1000 hours	±5%
	85°C, 1000 hours	±5%
Humidity aging	85°C, 85%RH, 1000 hours	±10%
Thermal shock	85°C, -40°C (10 times)	±10%
Solvent resistance	MIL-STD-202, Method 215F	No change

**RUEF**
**Physical Characteristics**

Lead material	RUEF090 to RUEF250: Tin-plated copper-clad steel, 0.205mm <sup>2</sup> (24AWG)
	RUEF300 to RUEF900: Tin-plated copper, 0.52mm <sup>2</sup> (20AWG), ø0.81mm (0.032in.)
Soldering characteristics	Solderability per ANSI/J-STD-002 Category 3
Solder heat withstand	per IEC-STD 68-2-20, Test Tb, Method1A, Condition B, can withstand 10 seconds at 260°C ±5°C
Insulating material	Cured, flame-retardant epoxy polymer; meets UL 94V-0
Operation temperature	-40°C~85°C

**Note:** Devices are not designed to be placed through a reflow process.

**Environmental Specifications**

Test	Conditions	Resistance Change
Passive aging	70°C, 1000 hours	±5%
	85°C, 1000 hours	±5%
Humidity aging	85°C, 85%RH, 1000 hours	±5%
Thermal shock	85°C, -40°C (10 times)	±5%
Solvent resistance	MIL-STD-202, Method 215F	No change

**RUSBF**
**Physical Characteristics**

Lead material	RUSBF075: Tin-plated nickel-copper alloy, 0.205mm <sup>2</sup> (24AWG), ø0.51mm/0.020in.
	RUSBF090 to RUSBF250: Tin-plated copper clad-steel, 0.205mm <sup>2</sup> (24AWG), ø0.51mm/0.020in.
Soldering characteristics	Solderability per ANSI/J-STD-002 Category 3 except RUSBF075 meet ANSI/J-STD-002 Category 1
Solder heat withstand	RUSBF120: per IEC-STD 68-2-20, Test Tb, Method 1A, Condition A; can withstand 5 seconds at 260°C ±5°C
	All others: per IEC-STD 68-2-20, Test Tb, Method 1A, Condition B; can withstand 10 seconds at 260°C ±5°C
Insulating material	Cured, flame-retardant epoxy polymer; meets UL 94V-0
Operation temperature	-40°C~85°C

**Note:** Devices are not designed to be placed through a reflow process.

**Environmental Specifications**

Test	Conditions	Resistance Change
Passive aging	70°C, 1000 hours	±5%
	85°C, 1000 hours	±5%
Humidity aging	85°C, 85%RH, 1000 hours	±5%
Thermal shock	85°C, -40°C (10 times)	±5%
Solvent resistance	MIL-STD-202, Method 215F	No change

**RGEF**
**Physical Characteristics**

Lead material	RGEF250: Tin-plated copper-clad steel, 0.205mm <sup>2</sup> (24AWG), ø0.51mm/0.020in. RGEF300 to RGEF1100 : Tin-plated copper, 0.52mm <sup>2</sup> (20AWG), ø0.81mm/0.032in. RGEF1200 to RGEF1400 : Tin-plated copper, 0.82mm <sup>2</sup> (18AWG), ø1.0mm/0.04in.
Soldering characteristics	Solderability per ANSI/J-STD-002 Category 3
Solder heat withstand	RGEF250 and RGEF400: per IEC 68-2-20, Test Tb, Method 1a, condition a; can withstand 5 seconds at 260°C ±5°C RGEF500 to RGEF1400: per IEC 68-2-20, Test Tb, Method 1a, condition b; can withstand 10 seconds at 260°C ±5°C
Insulating material	Cured, flame-retardant epoxy polymer; meets UL 94V-0
Operation temperature	-40°C~85°C

**Note:** Devices are not designed to be placed through a reflow process.

**Environmental Specifications**

Test	Conditions	Resistance Change
Passive aging	-40°C, 1000 hours	±5%
	85°C, 1000 hours	±5%
Humidity aging	85°C, 85%RH, 1000 hours	±5%
Thermal shock	85°C, -40°C (10 times)	±5%
Solvent resistance	MIL-STD-202, Method 215F	No change

**RHEF**
**Physical Characteristics**

Lead material	RHEF050 to RHEF200 : Tin-plated copper clad steel, 0.205mm <sup>2</sup> (24AWG), ø0.51mm/0.020in. RHEF300 to RHEF1100 : Tin-plated copper, 0.52mm <sup>2</sup> (20AWG), ø0.81mm/0.032in. RHEF1300 to RHEF1500 : Tin-plated copper, 0.82mm <sup>2</sup> (18AWG), ø1.0mm/0.04in.
Soldering characteristics	Solderability per ANSI/J-STD-002 Category 3
Solder heat withstand	per IEC 68-2-20, Test Tb, Method 1A, Condition B; can withstand 10 seconds at 260°C ±5°C
Insulating material	Cured, flame-retardant epoxy polymer; meets UL 94V-0
Operation temperature	-40°C~125°C

**Note:** Devices are not designed to be placed through a reflow process.

**Environmental Specifications**

Test	Conditions	Resistance Change
Passive aging	70°C, 1000 hours	±5%
	85°C, 1000 hours	±5%
Humidity aging	85°C, 85%RH, 1000 hours	±5%
Thermal shock	125°C, -40°C (10 times)	±5%
Solvent resistance	MIL-STD-202, Method 215F	No change

**Storage Conditions for Radial-leaded Devices**

Storage conditions	40°C max., 70% RH max.; devices should remain in original sealed bags prior to use. Devices may not meet specified values if these storage conditions are exceeded.
--------------------	--

**Note:** For the TR devices series, see the telecommunications and networking devices section.

**Table R6 Packaging and Marking Information for Radial-leaded Devices**

Part Number	Bag Quantity	Tape & Reel Quantity	Ammo Pack Quantity	Standard Package Quantity	Part Marking	Agency Recognition
<b>BBRF</b>						
<b>99V</b>						
BBRF550	500	—	—	10,000	BF550	UL, CSA
BBRF550-2	—	1,500	—	7,500	BF550	UL, CSA
<b>RXEF</b>						
<b>60V</b>						
RXEF005	500	—	—	10,000	—	UL, CSA, TÜV
RXEF005-2	—	3,000	—	15,000	—	UL, CSA, TÜV
RXEF005-AP	—	—	2,000	10,000	—	UL, CSA, TÜV
RXEF010	500	—	—	10,000	XF010	UL, CSA, TÜV
RXEF010-2	—	3,000	—	15,000	XF010	UL, CSA, TÜV
RXEF010-AP	—	—	2,000	10,000	XF010	UL, CSA, TÜV
RXEF017	500	—	—	10,000	XF017	UL, CSA, TÜV
RXEF017-2	—	2,500	—	12,500	XF017	UL, CSA, TÜV
RXEF017-AP	—	—	2,000	10,000	XF017	UL, CSA, TÜV
<b>RXEF</b>						
<b>72V</b>						
RXEF020	500	—	—	10,000	XF020	UL, CSA, TÜV
RXEF020-2	—	3,000	—	15,000	XF020	UL, CSA, TÜV
RXEF020-AP	—	—	2,000	10,000	XF020	UL, CSA, TÜV
RXEF025	500	—	—	10,000	XF025	UL, CSA, TÜV
RXEF025-2	—	3,000	—	15,000	XF025	UL, CSA, TÜV
RXEF025-AP	—	—	2,000	10,000	XF025	UL, CSA, TÜV
RXEF030	500	—	—	10,000	XF030	UL, CSA, TÜV
RXEF030-2	—	3,000	—	15,000	XF030	UL, CSA, TÜV
RXEF030-AP	—	—	2,000	10,000	XF030	UL, CSA, TÜV
RXEF040	500	—	—	10,000	XF040	UL, CSA, TÜV
RXEF040-2	—	3,000	—	15,000	XF040	UL, CSA, TÜV
RXEF040-AP	—	—	2,000	10,000	XF040	UL, CSA, TÜV
RXEF050	500	—	—	10,000	XF050	UL, CSA, TÜV
RXEF050-2	—	3,000	—	15,000	XF050	UL, CSA, TÜV
RXEF050-AP	—	—	2,000	10,000	XF050	UL, CSA, TÜV
RXEF065	500	—	—	10,000	XF065	UL, CSA, TÜV
RXEF065-2	—	3,000	—	15,000	XF065	UL, CSA, TÜV
RXEF065-AP	—	—	2,000	10,000	XF065	UL, CSA, TÜV
RXEF075	500	—	—	10,000	XF075	UL, CSA, TÜV
RXEF075-2	—	3,000	—	15,000	XF075	UL, CSA, TÜV
RXEF075-AP	—	—	2,000	10,000	XF075	UL, CSA, TÜV
RXEF090	500	—	—	10,000	XF090	UL, CSA, TÜV
RXEF090-2	—	3,000	—	15,000	XF090	UL, CSA, TÜV
RXEF090-AP	—	—	2,000	10,000	XF090	UL, CSA, TÜV
RXEF110	500	—	—	10,000	XF110	UL, CSA, TÜV
RXEF110-2	—	1,500	—	7,500	XF110	UL, CSA, TÜV
RXEF110-AP	—	—	1,000	5,000	XF110	UL, CSA, TÜV
RXEF135	500	—	—	10,000	XF135	UL, CSA, TÜV
RXEF135-2	—	1,500	—	7,500	XF135	UL, CSA, TÜV
RXEF135-AP	—	—	1,000	5,000	XF135	UL, CSA, TÜV
RXEF160	500	—	—	10,000	XF160	UL, CSA, TÜV
RXEF160-2	—	1,500	—	7,500	XF160	UL, CSA, TÜV
RXEF160-AP	—	—	1,000	5,000	XF160	UL, CSA, TÜV
RXEF185	500	—	—	10,000	XF185	UL, CSA, TÜV
RXEF185-2	—	1,500	—	7,500	XF185	UL, CSA, TÜV
RXEF185-AP	—	—	1,000	5,000	XF185	UL, CSA, TÜV

**Table R6 Packaging and Marking Information for Radial-leaded Devices**

Cont'd

Part Number	Bag Quantity	Tape & Reel Quantity	Ammo Pack Quantity	Standard Package Quantity	Part Marking	Agency Recognition
<b>RXEF</b>						
<b>72V</b>						
RXEF250	250	—	—	5,000	XF250	UL, CSA, TÜV
RXEF250-2	—	1,000	—	5,000	XF250	UL, CSA, TÜV
RXEF250-AP	—	—	1,000	5,000	XF250	UL, CSA, TÜV
RXEF300	250	—	—	5,000	XF300	UL, CSA, TÜV
RXEF300-2	—	1,000	—	5,000	XF300	UL, CSA, TÜV
RXEF300-AP	—	—	1,000	5,000	XF300	UL, CSA, TÜV
RXEF375	250	—	—	5,000	XF375	UL, CSA, TÜV
<b>RKEF</b>						
<b>60V</b>						
RKEF050	500	—	—	10,000	KF050	UL, CSA, TÜV
RKEF065	500	—	—	10,000	KF065	UL, CSA, TÜV
RKEF075	500	—	—	10,000	KF075	UL, CSA, TÜV
RKEF090	500	—	—	10,000	KF090	UL, CSA, TÜV
RKEF110	500	—	—	10,000	KF110	UL, CSA, TÜV
RKEF135	500	—	—	10,000	KF135	UL, CSA, TÜV
RKEF160	500	—	—	10,000	KF160	UL, CSA, TÜV
RKEF185	500	—	—	10,000	KF185	UL, CSA, TÜV
RKEF250	500	—	—	10,000	KF250	UL, CSA, TÜV
RKEF300	250	—	—	5,000	KF300	UL, CSA, TÜV
RKEF375	250	—	—	5,000	KF375	UL, CSA, TÜV
RKEF400	250	—	—	5,000	KF400	UL, CSA, TÜV
RKEF500	250	—	—	5,000	KF500	UL, CSA, TÜV
<b>RUEF</b>						
<b>30V</b>						
RUEF090	500	—	—	10,000	UF090	UL, CSA, TÜV, CQC
RUEF090-2	—	3,000	—	15,000	UF090	UL, CSA, TÜV, CQC
RUEF090-AP	—	—	2,000	10,000	UF090	UL, CSA, TÜV, CQC
RUEF110	500	—	—	10,000	UF110	UL, CSA, TÜV, CQC
RUEF110-2	—	3,000	—	15,000	UF110	UL, CSA, TÜV, CQC
RUEF110-AP	—	—	2,000	10,000	UF110	UL, CSA, TÜV, CQC
RUEF135	500	—	—	10,000	UF135	UL, CSA, TÜV, CQC
RUEF135-2	—	3,000	—	15,000	UF135	UL, CSA, TÜV, CQC
RUEF135-AP	—	—	2,000	10,000	UF135	UL, CSA, TÜV, CQC
RUEF160	500	—	—	10,000	UF160	UL, CSA, TÜV, CQC
RUEF160-2	—	3,000	—	15,000	UF160	UL, CSA, TÜV, CQC
RUEF160-AP	—	—	2,000	10,000	UF160	UL, CSA, TÜV, CQC
RUEF185	500	—	—	10,000	UF185	UL, CSA, TÜV, CQC
RUEF185-2	—	3,000	—	15,000	UF185	UL, CSA, TÜV, CQC
RUEF185-AP	—	—	2,000	10,000	UF185	UL, CSA, TÜV, CQC
RUEF250	500	—	—	10,000	UF250	UL, CSA, TÜV, CQC
RUEF250-2	—	3,000	—	15,000	UF250	UL, CSA, TÜV, CQC
RUEF250-AP	—	—	2,000	10,000	UF250	UL, CSA, TÜV, CQC
RUEF300	500	—	—	10,000	UF300	UL, CSA, TÜV, CQC
RUEF300-2	—	2,500	—	12,500	UF300	UL, CSA, TÜV, CQC
RUEF300-AP	—	—	1,000	5,000	UF300	UL, CSA, TÜV, CQC
RUEF400	500	—	—	10,000	UF400	UL, CSA, TÜV, CQC
RUEF400-2	—	1,500	—	7,500	UF400	UL, CSA, TÜV, CQC
RUEF400-AP	—	—	1,000	5,000	UF400	UL, CSA, TÜV, CQC
RUEF500	250	—	—	5,000	UF500	UL, CSA, TÜV, CQC
RUEF500-2	—	1,500	—	7,500	UF500	UL, CSA, TÜV, CQC
RUEF500-AP	—	—	1,000	5,000	UF500	UL, CSA, TÜV, CQC
RUEF600	250	—	—	5,000	UF600	UL, CSA, TÜV, CQC
RUEF600-2	—	1,000	—	5,000	UF600	UL, CSA, TÜV, CQC
RUEF600-AP	—	—	1,000	5,000	UF600	UL, CSA, TÜV, CQC

**Table R6 Packaging and Marking Information for Radial-leaded Devices**

Cont'd

Part Number	Bag Quantity	Tape & Reel Quantity	Ammo Pack Quantity	Standard Package Quantity	Part Marking	Agency Recognition
<b>RUEF</b>						
<b>30V</b>						
RUEF700	250	—	—	5,000	UF700	UL, CSA, TÜV, CQC
RUEF700-2	—	1,000	—	5,000	UF700	UL, CSA, TÜV, CQC
RUEF700-AP	—	—	1,000	5,000	UF700	UL, CSA, TÜV, CQC
RUEF800	250	—	—	5,000	UF800	UL, CSA, TÜV, CQC
RUEF800-2	—	1,000	—	5,000	UF800	UL, CSA, TÜV, CQC
RUEF800-AP	—	—	1,000	5,000	UF800	UL, CSA, TÜV, CQC
RUEF900	250	—	—	5,000	UF900	UL, CSA, TÜV, CQC
RUEF900-2	—	1,000	—	4,000	UF900	UL, CSA, TÜV, CQC
RUEF900-AP	—	—	1,000	4,000	UF900	UL, CSA, TÜV, CQC
<b>RHEF</b>						
<b>30V - High Temperature</b>						
RHEF050	500	—	—	10,000	HF0.5	UL, CSA, TÜV
RHEF050-2	—	2,500	—	12,500	HF0.7	UL, CSA, TÜV
RHEF070	500	—	—	10,000	HF0.7	UL, CSA, TÜV
RHEF070-2	—	2,500	—	12,500	HF0.7	UL, CSA, TÜV
RHEF100	500	—	—	10,000	HF1.0	UL, CSA, TÜV
RHEF100-2	—	2,500	—	12,500	HF1.0	UL, CSA, TÜV
<b>RUSBF</b>						
<b>16V</b>						
RUSBF090	500	—	—	10,000	RF090	UL, CSA, TÜV
RUSBF090-2	—	3,000	—	15,000	RF090	UL, CSA, TÜV
RUSBF090-AP	—	—	2,000	10,000	RF090	UL, CSA, TÜV
RUSBF110	500	—	—	10,000	RF110	UL, CSA, TÜV
RUSBF110-2	—	3,000	—	15,000	RF110	UL, CSA, TÜV
RUSBF110-AP	—	—	2,000	10,000	RF110	UL, CSA, TÜV
RUSBF135	500	—	—	10,000	RF135	UL, CSA, TÜV
RUSBF135-2	—	3,000	—	15,000	RF135	UL, CSA, TÜV
RUSBF135-AP	—	—	2,000	10,000	RF135	UL, CSA, TÜV
RUSBF160	500	—	—	10,000	RF160	UL, CSA, TÜV
RUSBF160-2	—	3,000	—	15,000	RF160	UL, CSA, TÜV
RUSBF160-AP	—	—	2,000	10,000	RF160	UL, CSA, TÜV
RUSBF185	500	—	—	10,000	RF185	UL, CSA, TÜV
RUSBF185-2	—	3,000	—	15,000	RF185	UL, CSA, TÜV
RUSBF185-AP	—	—	2,000	10,000	RF185	UL, CSA, TÜV
RUSBF250	500	—	—	10,000	RF250	UL, CSA, TÜV
RUSBF250-2	—	3,000	—	15,000	RF250	UL, CSA, TÜV
RUSBF250-AP	—	—	2,000	10,000	RF250	UL, CSA, TÜV
<b>RGEF</b>						
<b>16V</b>						
RGEF250	500	—	—	10,000	GF250	UL, CSA, TÜV
RGEF250-2	—	3,000	—	15,000	GF250	UL, CSA, TÜV
RGEF250-AP	—	—	2,000	10,000	GF250	UL, CSA, TÜV
RGEF300	500	—	—	10,000	GF300	UL, CSA, TÜV
RGEF300-2	—	2,500	—	12,500	GF300	UL, CSA, TÜV
RGEF300-AP	—	—	2,000	10,000	GF300	UL, CSA, TÜV
RGEF400	500	—	—	10,000	GF400	UL, CSA, TÜV
RGEF400-2	—	2,500	—	12,500	GF400	UL, CSA, TÜV
RGEF400-AP	—	—	2,000	10,000	GF400	UL, CSA, TÜV
RGEF500	500	—	—	10,000	GF500	UL, CSA, TÜV
RGEF500-2	—	2,000	—	10,000	GF500	UL, CSA, TÜV
RGEF500-AP	—	—	2,000	10,000	GF500	UL, CSA, TÜV
RGEF600	500	—	—	10,000	GF600	UL, CSA, TÜV
RGEF600-2	—	2,000	—	10,000	GF600	UL, CSA, TÜV
RGEF600-AP	—	—	2,000	10,000	GF600	UL, CSA, TÜV

**Table R6 Packaging and Marking Information for Radial-leaded Devices**

Cont'd

Part Number	Bag Quantity	Tape & Reel Quantity	Ammo Pack Quantity	Standard Package Quantity	Part Marking	Agency Recognition
<b>RGEF</b>						
<b>16V</b>						
RGEF700	500	—	—	10,000	GF700	UL, CSA, TÜV
RGEF700-2	—	1,500	—	7,500	GF700	UL, CSA, TÜV
RGEF700-AP	—	—	1,500	7,500	GF700	UL, CSA, TÜV
RGEF800	500	—	—	10,000	GF800	UL, CSA, TÜV
RGEF800-2	—	1,000	—	5,000	GF800	UL, CSA, TÜV
RGEF800-AP	—	—	1,000	5,000	GF800	UL, CSA, TÜV
RGEF900	500	—	—	10,000	GF900	UL, CSA, TÜV
RGEF900-2	—	1,000	—	5,000	GF900	UL, CSA, TÜV
RGEF900-AP	—	—	1,000	5,000	GF900	UL, CSA, TÜV
RGEF1000	250	—	—	5,000	GF1000	UL, CSA, TÜV
RGEF1000-2	—	1,000	—	5,000	GF1000	UL, CSA, TÜV
RGEF1000-AP	—	—	1,000	5,000	GF1000	UL, CSA, TÜV
RGEF1100	250	—	—	5,000	GF1100	UL, CSA, TÜV
RGEF1100-2	—	1,000	—	5,000	GF1100	UL, CSA, TÜV
RGEF1100-AP	—	—	1,000	5,000	GF1100	UL, CSA, TÜV
RGEF1200	250	—	—	5,000	GF1200	UL, CSA, TÜV
RGEF1200-2	—	1,000	—	5,000	GF1200	UL, CSA, TÜV
RGEF1200-AP	—	—	1,000	5,000	GF1200	UL, CSA, TÜV
RGEF1400	250	—	—	5,000	GF1400	UL, CSA, TÜV
RGEF1400-2	—	1,000	—	5,000	GF1400	UL, CSA, TÜV
RGEF1400-AP	—	—	1,000	5,000	GF1400	UL, CSA, TÜV
<b>RHEF</b>						
<b>16V - High Temperature</b>						
RHEF200	500	—	—	10,000	HF2.0	UL, CSA, TÜV
RHEF200-2	—	2,500	—	12,500	HF2.0	UL, CSA, TÜV
RHEF200-AP	—	—	2,500	12,500	HF2.0	UL, CSA, TÜV
RHEF300	500	—	—	10,000	HF3	UL, CSA, TÜV
RHEF300-2	—	2,000	—	10,000	HF3	UL, CSA, TÜV
RHEF300-AP	—	—	2,000	10,000	HF3	UL, CSA, TÜV
RHEF400	500	—	—	10,000	HF4	UL, CSA, TÜV
RHEF400-2	—	1,500	—	7,500	HF4	UL, CSA, TÜV
RHEF400-AP	—	—	1,500	7,500	HF4	UL, CSA, TÜV
RHEF450	500	—	—	10,000	HF4.5	UL, CSA, TÜV
RHEF450-2	—	1,500	—	7,500	HF4.5	UL, CSA, TÜV
RHEF450-AP	—	—	1,500	7,500	HF4.5	UL, CSA, TÜV
RHEF550	500	—	—	10,000	HF5.5	UL, CSA, TÜV
RHEF550-2	—	2,000	—	10,000	HF5.5	UL, CSA, TÜV
RHEF550-AP	—	—	2,000	10,000	HF5.5	UL, CSA, TÜV
RHEF600	500	—	—	10,000	HF6	UL, CSA, TÜV
RHEF600-2	—	1,500	—	7,500	HF6	UL, CSA, TÜV
RHEF600-AP	—	—	1,500	7,500	HF6	UL, CSA, TÜV
RHEF650	500	—	—	10,000	HF6.5	UL, CSA, TÜV
RHEF650-2	—	1,500	—	7,500	HF6.5	UL, CSA, TÜV
RHEF650-AP	—	—	1,500	7,500	HF6.5	UL, CSA, TÜV
RHEF700	500	—	—	10,000	HF7	UL, CSA, TÜV
RHEF700-2	—	1,500	—	7,500	HF7	UL, CSA, TÜV
RHEF700-AP	—	—	1,500	7,500	HF7	UL, CSA, TÜV
RHEF750	500	—	—	10,000	HF7.5	UL, CSA, TÜV
RHEF750-2	—	1,000	—	5,000	HF7.5	UL, CSA, TÜV
RHEF750-AP	—	—	1,000	5,000	HF7.5	UL, CSA, TÜV
RHEF800	500	—	—	10,000	HF8	UL, CSA, TÜV
RHEF800-2	—	1,000	—	5,000	HF8	UL, CSA, TÜV
RHEF800-AP	—	—	1,000	5,000	HF8	UL, CSA, TÜV

**Table R6 Packaging and Marking Information for Radial-leaded Devices**

Cont'd

Part Number	Bag Quantity	Tape & Reel Quantity	Ammo Pack Quantity	Standard Package Quantity	Part Marking	Agency Recognition
<b>RHEF</b>						
<b>16V - High Temperature</b>						
RHEF900	250	—	—	5,000	HF9	UL, CSA, TÜV
RHEF900-2	—	1,000	—	5,000	HF9	UL, CSA, TÜV
RHEF900-AP	—	—	1,000	5,000	HF9	UL, CSA, TÜV
RHEF1000	250	—	—	5,000	HF10	UL, CSA, TÜV
RHEF1000-2	—	1,000	—	5,000	HF10	UL, CSA, TÜV
RHEF1000-AP	—	—	1,000	5,000	HF10	UL, CSA, TÜV
RHEF1100	250	—	—	5,000	HF11	UL, CSA, TÜV
RHEF1100-2	—	1,000	—	5,000	HF11	UL, CSA, TÜV
RHEF1100-AP	—	—	1,000	5,000	HF11	UL, CSA, TÜV
RHEF1300	250	—	—	5,000	HF13	UL, CSA, TÜV
RHEF1300-2	—	1,000	—	5,000	HF13	UL, CSA, TÜV
RHEF1300-AP	—	—	1,000	5,000	HF13	UL, CSA, TÜV
RHEF1400	250	—	—	5,000	HF14	UL, CSA, TÜV
RHEF1400-2	—	1,000	—	5,000	HF14	UL, CSA, TÜV
RHEF1400-AP	—	—	1,000	5,000	HF14	UL, CSA, TÜV
RHEF1500	250	—	—	5,000	HF15	UL, CSA, TÜV
RHEF1500-2	—	1,000	—	5,000	HF15	UL, CSA, TÜV
RHEF1500-AP	—	—	1,000	5,000	HF15	UL, CSA, TÜV
<b>RUSBF</b>						
<b>6V</b>						
RUSBF075	500	—	—	10,000	RF075	UL, CSA, TÜV
RUSBF075-2	—	3,000	—	15,000	RF075	UL, CSA, TÜV
RUSBF075-AP	—	—	2,000	10,000	RF075	UL, CSA, TÜV
RUSBF120	500	—	—	10,000	RF120	UL, CSA, TÜV
RUSBF120-2	—	3,000	—	15,000	RF120	UL, CSA, TÜV
RUSBF120-AP	—	—	2,000	10,000	RF120	UL, CSA, TÜV
RUSBF155	500	—	—	10,000	RF155	UL, CSA, TÜV
RUSBF155-2	—	3,000	—	15,000	RF155	UL, CSA, TÜV
RUSBF155-AP	—	—	2,000	10,000	RF155	UL, CSA, TÜV

**Agency Recognitions for Radial-leaded Devices**

UL	File # E74889
CSA	File # CA78165
TÜV	Certificate number available on request (per IEC 60730-1).

**Table R7 Tape and Reel Specifications for Radial-leaded Devices**

RXEF, BBRF and RKEF devices are available in tape and reel packaging per EIA468-B/IEC60286-2 standards. See Figures R22 and R23 for details.

Description	EIA Mark	Dimension (mm)	Tolerance
Carrier tape width	W	18	-0.5/+1.0
Hold-down tape width	W <sub>4</sub>	11	Minimum
Top distance between tape edges	W <sub>6</sub>	3	Maximum
Sprocket hole position	W <sub>5</sub>	9	-0.5/+0.75
Sprocket hole diameter	D <sub>0</sub>	4	± 0.2
Abscissa to plane (straight lead) (RXEF110 to RXEF300, RKEF135 to RKEF500)	H	18.5	± 2.5
Abscissa to plane (kinked lead) (RXEF010 to RXEF090, BBRF550, RKEF050 to RKEF110)	H <sub>0</sub>	16.0	± 0.5
Abscissa to top (RXEF010 to RXEF090, BBRF550, RKEF050 to RKEF185)	H <sub>1</sub>	32.2	Maximum
Abscissa to top* (RXEF110 to RXEF300, RKEF250 to RKEF500)	H <sub>1</sub>	47.5	Maximum
Overall width with lead protrusion (RXEF010 to RXEF090, BBRF550, RKEF050 to RKEF185)	C <sub>1</sub>	43.2	Maximum
Overall width with lead protrusion* (RXEF110 to RXEF300, RKEF250 to RKEF500)	C <sub>1</sub>	58	Maximum
Overall width without lead protrusion (RXEF010 to RXEF090, BBRF550, RKEF050 to RKEF185)	C <sub>2</sub>	42.5	Maximum
Overall width without lead protrusion* (RXEF110 to RXEF300, RKEF250 to RKEF500)	C <sub>2</sub>	57	Maximum
Lead protrusion	L <sub>1</sub>	1.0	Maximum
Protrusion of cut-out	L	11.0	Maximum
Protrusion beyond hold-down tape	I <sub>2</sub>	Not specified	—
Sprocket hole pitch	P <sub>0</sub>	12.7	± 0.3
Device pitch (RXEF010 to RXEF090, BBRF550, RKEF050 to RKEF185)	—	12.7	± 0.3
Device pitch (RXEF110 to RXEF300, RKEF250 to RKEF500)	—	25.4	± 0.61
Pitch tolerance	—	20 consecutive	± 1
Tape thickness	t	0.9	Maximum
Overall tape and lead thickness (RXEF010 to RXEF090, RKEF050 to RKEF185)	t <sub>1</sub>	1.5	Maximum
Overall tape and lead thickness (RXEF110 to RXEF300, BBRF550, RKEF250 to RKEF500)	t <sub>1</sub>	2.3	Maximum
Splice sprocket hole alignment	—	0	± 0.3
Body lateral deviation	Δh	0	± 1.0
Body tape plane deviation	Δp	0	± 1.3
Ordinate to adjacent component lead (RXEF010 to RXEF185, BBRF550, RKEF050 to RKEF300)	P <sub>1</sub>	3.81	± 0.7
Ordinate to adjacent component lead (RXEF250 to RXEF300, RKEF375 to RKEF500)	P <sub>1</sub>	7.62	± 0.7
Lead spacing* (RXEF010 to RXEF185, BBRF550, RKEF050 to RKEF300)	F	5.05	± 0.75
Lead spacing* (RXEF250 to RXEF300, RKEF375 to RKEF500)	F	10.15	± 0.75
Reel width (RXEF010 to RXEF090, RKEF050 to RKEF185)	w <sub>2</sub>	56.0	Maximum
Reel width* (RXEF110 to RXEF300, RKEF250 to RKEF500)	w <sub>2</sub>	63.5	Maximum
Reel diameter	a	370.0	Maximum
Space between flanges* (RXEF010 to RXEF090, RKEF050 to RKEF185)	w <sub>1</sub>	48.00	Maximum
Space between flanges* (RXEF110 to RXEF300, RKEF250 to RKEF500)	w <sub>1</sub>	55.00	Maximum
Arbor hold diameter	c	26.0	± 12.0
Core diameter*	n	91.0	Maximum
Box	—	64/372/362	Maximum
Consecutive missing places	—	None	—
Empty places per reel	—	0.1%	Maximum

\*Differs from EIA specification.



**Table R7 Tape and Reel Specifications for Radial-leaded Devices**

Cont'd

RUEF and RUSBF devices are available in tape and reel packaging per EIA468-B/IEC60286-2 standards. See Figures R22 and R23 for details.

Description	EIA Mark	Dimension (mm)	Tolerance
Carrier tape width	W	18	-0.5/+1.0
Hold-down tape width	W <sub>4</sub>	11	Minimum
Top distance between tape edges	W <sub>6</sub>	3	Maximum
Sprocket hole position	W <sub>5</sub>	9	-0.5/+0.75
Sprocket hole diameter	D <sub>0</sub>	4	± 0.2
Abscissa to plane (straight lead)* (RUEF300 to RUEF900)	H	18.5	± 2.5
Abscissa to plane (kinked lead) (RUSBF075 to RUSBF250, RUEF090 to RUEF250)	H <sub>0</sub>	16.0	± 0.5
Abscissa to top (RUSBF075 to RUSBF250, RUEF090 to RUEF300)	H <sub>1</sub>	32.2	Maximum
Abscissa to top* (RUEF400 to RUEF900)	H <sub>1</sub>	45.0	Maximum
Overall width with lead protrusion (RUSBF075 to RUSBF250, RUEF090 to RUEF300)	C <sub>1</sub>	43.2	Maximum
Overall width with lead protrusion (RUEF400 to RUEF900)	C <sub>1</sub>	56	Maximum
Overall width without lead protrusion (RUSBF075 to RUSBF250, RUEF090 to RUEF300)	C <sub>2</sub>	42.5	Maximum
Overall width without lead protrusion (RUEF400 to RUEF900)	C <sub>2</sub>	56	Maximum
Lead protrusion	L <sub>1</sub>	1.0	Maximum
Protrusion of cut-out	L	11	Maximum
Protrusion beyond hold-down tape	I <sub>2</sub>	Not specified	—
Sprocket hole pitch	P <sub>0</sub>	12.7	± 0.3
Device pitch (RUSBF075 to RUSBF250, RUEF090 to RUEF300)	—	12.7	± 0.3
Device pitch (RUEF400 to RUEF900)	—	25.4	± 0.6
Pitch tolerance	—	20 consecutive	± 1
Tape thickness	t	0.9	Maximum
Overall tape and lead thickness (RUSBF075 to RUSBF250, RUEF090 to RUEF250)	t <sub>1</sub>	1.5	Maximum
Overall tape and lead thickness* (RUEF300 to RUEF900)	t <sub>1</sub>	2.3	Maximum
Splice sprocket hole alignment	—	0	± 0.3
Body lateral deviation	Δh	0	± 1.0
Body tape plane deviation	Δp	0	± 1.3
Ordinate to adjacent component lead (RUSBF075 to RUSBF250, RUEF090 to RUEF300)	P <sub>1</sub>	3.81	± 0.7
Ordinate to adjacent component lead (RUEF400 to RUEF900)	P <sub>1</sub>	7.62	± 0.7
Lead spacing* (RUSBF075 to RUSBF250, RUEF090 to RUEF400)	F	5.05	± 0.75
Lead spacing* (RUEF500 to RUEF900)	F	10.15	± 0.75
Reel width (RUEF090 to RUEF400, RUSBF075 to RUSBF250)	w <sub>2</sub>	56.0	Maximum
Reel width (RUEF500* to RUEF900)	w <sub>2</sub>	63.5	Maximum
Reel diameter	a	370.0	Maximum
Space between flanges* (RUEF090 to RUEF400, RUSBF075 to RUSBF250)	w <sub>1</sub>	48.0	Maximum
Space between flanges* (RUEF500 to RUEF900)	w <sub>1</sub>	55.0	Maximum
Arbor hold diameter	c	26.0	± 12.0
Core diameter*	n	91.0	Maximum
Box	—	64/372/362	Maximum
Consecutive missing places	—	None	—
Empty places per reel	—	0.1%	Maximum

\*Differs from EIA specification.

**Table R7 Tape and Reel Specifications for Radial-leaded Devices**

Cont'd

RGEF and RHEF devices are available in tape and reel packaging per EIA468-B/IEC60286-2 standards. See Figures R22 and R23 for details.

Description	EIA Mark	Dimension (mm)	Tolerance
Carrier tape width	W	18	-0.5/+1.0
Hold-down tape width	W <sub>4</sub>	11	Minimum
Top distance between tape edges	W <sub>6</sub>	3	Maximum
Sprocket hole position	W <sub>5</sub>	9	-0.5/+0.75
Sprocket hole diameter	D <sub>0</sub>	4	± 0.2
Abscissa to plane (straight lead) (RGEF250 to RGEF1400)	H	18.5	± 2.5
Abscissa to plane (kinked lead) (RHEF050 to RHEF1500)	H <sub>0</sub>	16.0	± 0.5
Abscissa to top (RGEF250 to RGEF500, RHEF050 to RHEF450)	H <sub>1</sub>	32.2	Maximum
Abscissa to top* (RGEF600 to RGEF1400, RHEF550 to RHEF1500)	H <sub>1</sub>	45.0	Maximum
Overall width with lead protrusion (RGEF250 to RGEF600, RHEF050 to RHEF450)	C <sub>1</sub>	43.2	Maximum
Overall width with lead protrusion (RGEF700 to RGEF1400, RHEF550 to RHEF1500)	C <sub>1</sub>	55	Maximum
Overall width without lead protrusion (RGEF250 to RGEF600, RHEF050 to RHEF450)	C <sub>2</sub>	42.5	Maximum
Overall width without lead protrusion (RGEF700 to RGEF1400, RHEF550 to RHEF1500)	C <sub>2</sub>	54	Maximum
Lead protrusion	L <sub>1</sub>	1.0	Maximum
Protrusion of cut-out	L	11	Maximum
Protrusion beyond hold-down tape	I <sub>2</sub>	Not specified	—
Sprocket hole pitch	P <sub>0</sub>	12.7	± 0.3
Device pitch (RGEF250 to RGEF700, RHEF050 to RHEF600)	—	25.4	± 0.61
Device pitch (RGEF800 to RGEF1400, RHEF650 to RHEF1500)	—	25.4	± 0.6
Pitch tolerance	—	20 consecutive	± 1
Tape thickness	t	0.9	Maximum
Overall tape and lead thickness* (RGEF250 to RGEF1100, RHEF050 to RHEF1100)	t <sub>1</sub>	2.0	Maximum
Overall tape and lead thickness* (RGEF1200 to RGEF1400, RHEF1300 to RHEF1500)	t <sub>1</sub>	2.3	Maximum
Splice sprocket hole alignment	—	0	± 0.3
Body lateral deviation	Δh	0	± 1.0
Body tape plane deviation	Δp	0	± 1.3
Ordinate to adjacent component lead (RGEF250 to RGEF1100, RHEF050 to RHEF900)	P <sub>1</sub>	3.81	± 0.7
Ordinate to adjacent component lead (RGEF1200 to RGEF1400, RHEF1000 to RHEF1500)	P <sub>1</sub>	7.62	± 0.7
Lead spacing* (RGEF250 to RGEF1100, RHEF050 to RHEF900)	F	5.05	± 0.75
Lead spacing* (RGEF1200 to RGEF1400, RHEF1000 to RHEF1500)	F	10.15	± 0.75
Reel width (RGEF250 to RGEF600, RHEF050 to RHEF450)	w <sub>2</sub>	56.0	Maximum
Reel width* (RGEF700 to RGEF1400 & RHEF550 to RHEF1500)	w <sub>2</sub>	63.5	Maximum
Reel diameter	a	370.0	Maximum
Space between flanges* (RGEF250 to RGEF600, RHEF050 to RHEF450)	w <sub>1</sub>	48.0	Maximum
Space between flanges* (RGEF700 to RGEF1400, RHEF550 to RHEF1500)	w <sub>1</sub>	55.0	Maximum
Arbor hold diameter	c	26.0	± 12.0
Core diameter*	n	91.0	Maximum
Box	—	64/372/362	Maximum
Consecutive missing places	—	None	—
Empty places per reel	—	0.1%	Maximum

\*Differs from EIA specification.

**Figure R22 EIA Referenced Taped Component Dimensions for Radial-leaded Devices**

**Figure R23 EIA Referenced Reel Dimensions for Radial-leaded Devices**

**Part Numbering System for Radial-leaded Devices**
**RUEF 250 U 2**

**Packaging**

- Blank = Packaged in bags
- 1 = 25.4mm (1.0 inch) minimum lead length
- 2 = Tape and reel
- AP = Ammo pack
- X.X = Special lead cut length (inch)

**Modifier**

- K = Standard kinked lead
- B = Special kinked lead
- S = Straight lead
- U = Uncoated device

**Hold Current Indicator**
**Product Series**

An "F" at the end of product series indicates Pb-free version of product.

**Note:** Kinked part is recommended to well control the height of part on the PCB in non-auto PCB application.

**Warning :**

- Users should independently evaluate the suitability of and test each product selected for their own application.
- Operation beyond the maximum ratings or improper use may result in device damage and possible electrical arcing and flame.
- These devices are intended for protection against damage caused by occasional overcurrent or overtemperature fault conditions and should not be used when repeated fault conditions or prolonged trip events are anticipated.
- Contamination of the PPTC material with certain silicone-based oils or some aggressive solvents can adversely impact the performance of the devices.
- Device performance can be impacted negatively if devices are handled in a manner inconsistent with recommended electronic, thermal, and mechanical procedures for electronic components.
- PPTC devices are not recommended for installation in applications where the device is constrained such that its PTC properties are inhibited, for example in rigid potting materials or in rigid housings, which lack adequate clearance to accommodate device expansion.
- Operation in circuits with a large inductance can generate a circuit voltage ( $Ldi/dt$ ) above the rated voltage of the device.