

Features

- 4:1 Wide Input Voltage Range
- 30 Watts Output Power
- 1.6kVDC Isolation
- UL Pending
- Fixed Operating Frequency
- Six-Sided Continuous Shield
- Standard 50.8 x25.4x10.2mm Package
- Efficiency to 91%

POWERLINE
DC/DC-Converter

RECOM

Description

The RP30-FW series DC/DC converters are designed to meet to UL 60950-1 and to cUL 60950-1. This makes them ideal for all telecom and industrial applications where approved safety standards are required. The industry standard 2" x 1" package meets military standards for thermal shock and vibration tolerance.

Selection Guide 24V and 48V Input Types

Part Number	Input Range	Output Voltage	Output Current	Input Current ⁽⁴⁾		Efficiency ⁽⁵⁾	Capacitive ⁽⁶⁾ Load max.
	VDC	VDC	mA	No Load	Full Load		
RP30-243.3SFW	9-36	3.3	7500	70	1258	86	20000µF
RP30-2405SFW	9-36	5	6000	105	1488	88	14400µF
RP30-2412SFW	9-36	12	2500	20	1471	89	3000µF
RP30-2415SFW	9-36	15	2000	30	1471	89	2000µF
RP30-483.3SFW	18-75	3.3	7500	45	629	86	20000µF
RP30-4805SFW	18-75	5	6000	65	744	88	14400µF
RP30-4812SFW	18-75	12	2500	60	727	90	3000µF
RP30-4815SFW	18-75	15	2000	50	718	91	2000µF
RP30-2405DFW	9-36	±5	±3000	90	1488	88	±3000µF
RP30-2412DFW	9-36	±12	±1250	25	1506	87	±2000µF
RP30-2415DFW	9-36	±15	±1000	25	1506	87	±1300µF
RP30-4805DFW	18-75	±5	±3000	50	744	88	±3000µF
RP30-4812DFW	18-75	±12	±1250	15	744	88	±2000µF
RP30-4815DFW	18-75	±15	±1000	15	744	88	±1300µF



UL-60950-1 Certified
E196683

RP30-FW

* no suffix for CTRL function with Positive Logic (1=ON, 0=OFF), this is standard

* add **N** for CTRL function with Negative Logic (0=ON, 1=OFF)

* add suffix **-HC** for premounted heatsink and clips

Ordering Examples

RP30-2405SFW = 24V Input, 5V Output, Positive Logic CTRL pin fitted

RP30-4812DFW/N-HC = 48V Input, ±12V Output, Negative Logic CTRL pin fitted, Heatsink fitted

Please Read Application
Notes

www.recom-electronic.com

Derating Graph (Ambient Temperature)

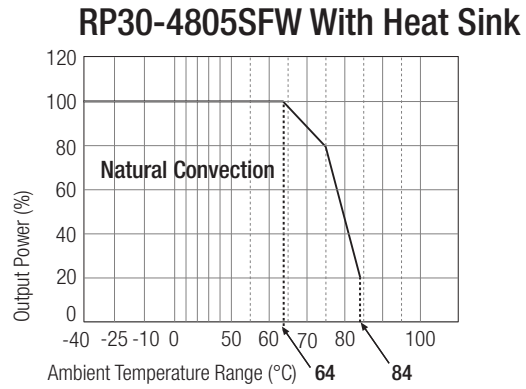
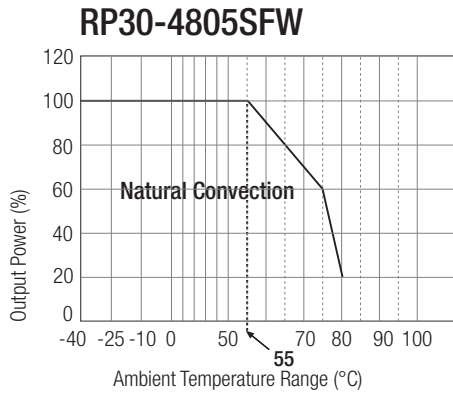

Derating graphs are valid only for the shown part numbers. If you need detailed derating-information about a part-number not shown here please contact our technical support service at info@recom-development.at

Typical Characteristics

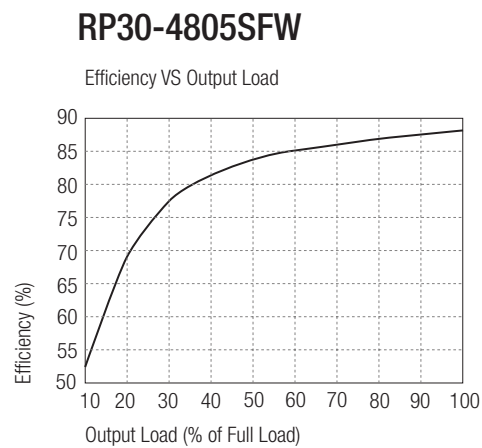
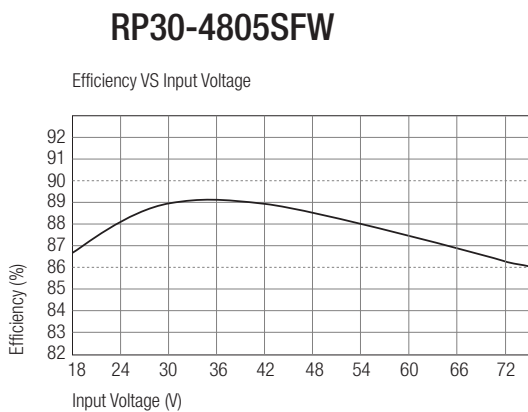

Specifications (typical at nominal input and 25°C unless otherwise noted)

Input Voltage Range	24V nominal input	9-36VDC
	48V nominal input	18-75VDC
Input Filter		Pi Type
Input Surge Voltage (100 ms max.)	24V Input	50VDC
	48V Input	100VDC
Input Reflected Ripple (nominal Vin and full load) (see Note 3)		20mA _{p-p}
Start Up Time (nominal Vin and constant resistor load)	Power up	30ms typ.
	Remote ON/OFF	30ms typ.
Start-up voltage	24V Input	9VDC
	48V Input	18VDC
Shutdown voltage	24V Input	8VDC
	48V Input	16VDC

continued on next page

Specifications (typical at nominal input and 25°C unless otherwise noted)

Remote ON/OFF (Optional. See Note 7) (Positive logic)(Standard)	DC-DC ON	Open or 3V < Vr < 12V
	DC-DC OFF	Short or 0V < Vr < 1.2V
(Negative logic)(Option)	DC-DC ON	Short or 0V < Vr < 1.2V
	DC-DC OFF	Open or 3V < Vr < 12V
Input current of Remote control pin	Nominal input	-0.5mA ~ +0.5mA
Remote OFF state input current	Nominal input	3mA
Output Power		30W max.
Output Voltage Accuracy (full Load and nominal Vin)		±1%
Voltage Adjustability		±10%
Minimum Load		0%
Line Regulation (low line, high line at full load)		±0.2%
Load Regulation (No load to full load)	Single	±0.5%
	Dual	±1%
Cross Regulation (asymmetrical 25% <>100% load)	Dual	±5%
Ripple and Noise (20MHz bandwidth)	3.3, 5V	100mVp-p
(Measured with a 1uF/50V MLCC)	12, 15V	150mVp-p
Temperature Coefficient		±0.02%/°C max.
Transient Response (25% load step change)		250µs
Over Voltage Protection	3.3V	3.9V
Zener diode clamp (only single)	5V, ±5V	6.2V
	12V, ±12V	15V
	15V, ±15V	18V
Over Load Protection (% of full load at nominal Vin)		150% typ
Short Circuit Protection		Hiccup, automatic recovery
Efficiency		see „Selection Guide“ table
Isolation Voltage	Input to Output	1600VDC min.
	Input (Output) to case	1600VDC min.
Case grounding		Connect case to -Vin with decoupling Y Cap
Isolation Resistance		1GΩ min.
Isolation Capacitance		1500pF max.
Operating Frequency		430kHz typ.
Operating Temperature Range		-40°C to +50°C(without derating) -40°C to +85°C(with derating)
Maximum Case Temperature		+105°C
Storage Temperature Range		-55°C to +125°C
Over Temperature Protection		+115°C typ.
Thermal Impedance	Natural convection	12°C/Watt
(see Note 8)	Natural convection with Heat Sink	10°C/Watt
Thermal Shock		MIL-STD-810F
Vibration		MIL-STD-810F
Relative Humidity		5% to 95% RH
Case Material		Nickel plated copper
Base Material		FR4 PCB
Potting Material		Epoxy (UL94-V0)

continued on next page

Specifications (typical at nominal input and 25°C unless otherwise noted)

EMI (see Note 10)	EN55022		Class A
ESD	EN61000-4-2	Air ±8KV	Perf. Criteria A
	EN61000-4-2	Contact ±6KV	Perf. Criteria A
Radiated Immunity	EN61000-4-3	10V/m	Perf. Criteria A
Fast Transient (see Note 9)	EN61000-4-4	±2KV	Perf. Criteria A
Surge (see Note 9)	EN61000-4-5	±1KV	Perf. Criteria A
Conducted Immunity	EN61000-4-6	10 Vr.m.s	Perf. Criteria A
Weight			30.5g
Dimensions			50.8 x 25.4 x 10.2mm
MTBF (see Note 2)	Belcore-TR-NWT-000332		3.163 x 10 ⁶ hours
	MIL-HDBK-217F		4.347 x 10 ⁵ hours

Notes :

- The RP30-S_DFW series does not require any minimum load.
- BELLCORE TR-NWT-000332. Case I: 50% Stress, Temperature at 40°C (Ground fixed and controlled environment)
MIL-HDBK-217F Notice2 @ TA= 25°C, Full load (Ground, Begign, controlled environment)
- Simulated source impedance of 12µH. 12µH inductor in series with +Vin.
- Typical value at nominal input voltage and no load of standard type
Maximum value at nominal input voltage and full load of standard type.
- Typical value at nominal input voltage and full load.
- Test by minimum Vin and constant resistor load.
- The ON/OFF control function can be positive or negative logic. The pin voltage is referenced to negative input.
Positive logic ON/OFF is standard, no suffix (Ex. RP30-2405SFW)
Negative logic ON/OFF is marked with suffix-N (Ex. R320-2405SFW/N).
- Heat sink is optional and P/N: 7G-0020C . Powerline DC/DC Converters can be ordered with pre-mounted heatsinks including antivibration fixing clips (add suffix -HC). See Application Notes for heatsink details.
- An external filter capacitor is required if the module has to meet EN61000-4-4,EN61000-4-5.
The filter capacitor RECOM suggest: 24Vin : Nippon chemi-con KY series, 330?F/50V, ESR 55m?.
48Vin : Nippon chemi-con KY series, 220?F/100V, ESR 48m?.
- Meets class A with external components shown below. See application notes for Class B common mode filter suggestion

RP30-FW

Package Style and Pinning (mm)

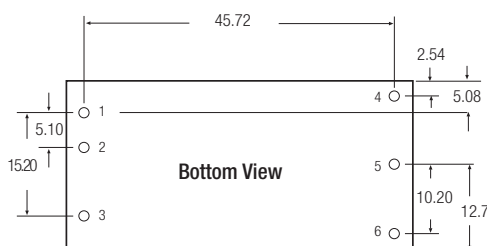
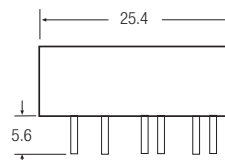
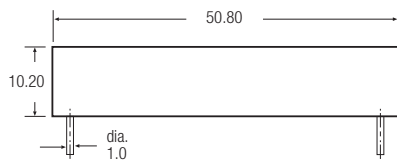

Pin Connections

Pin #	Single	Dual
1	+Vin	+Vin
2	-Vin	-Vin
3	CTRL	CTRL
4	+Vout	+Vout
5	-Vout	Com
6	Trim	-Vout

Pin Pitch Tolerance ±0.25 mm

EMC Filtering - For Class A filter suggestion, see Application Notes

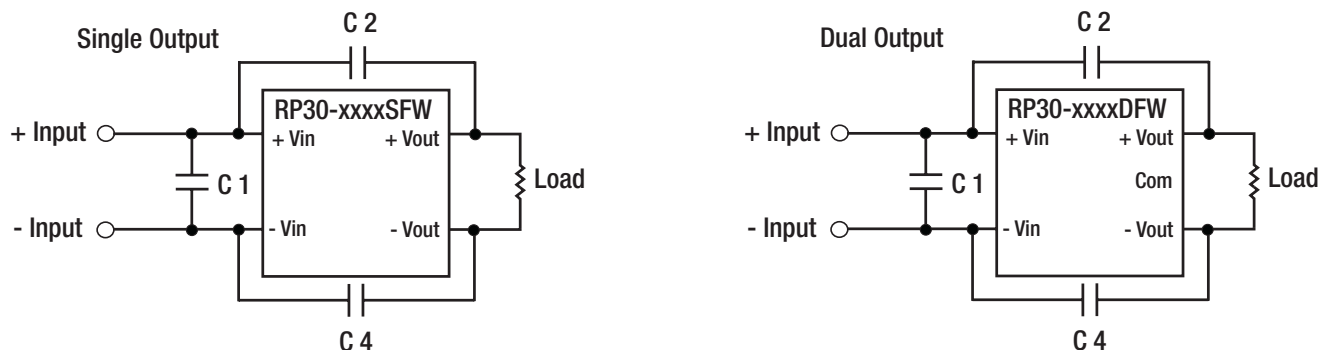

Single Output	C1	C2 & C3
RP30-24xxSFW	6.8 μ F/50V 1812 MLCC	1000pF/2KV 1808 MLCC
RP30-48xxSFW	2.2 μ F/100V 1812 MLCC	1000pF/2KV 1808 MLCC

Dual Output	C1	C2 & C4
RP30-24xxDFW	6.8 μ F/50V 1812 MLCC	1000pF/2KV 1808 MLCC
RP30-48xxDFW	2.2 μ F/100V 1812 MLCC	1000pF/2KV 1808 MLCC

Recommended EN55022 Class A Filter Circuit Layouts

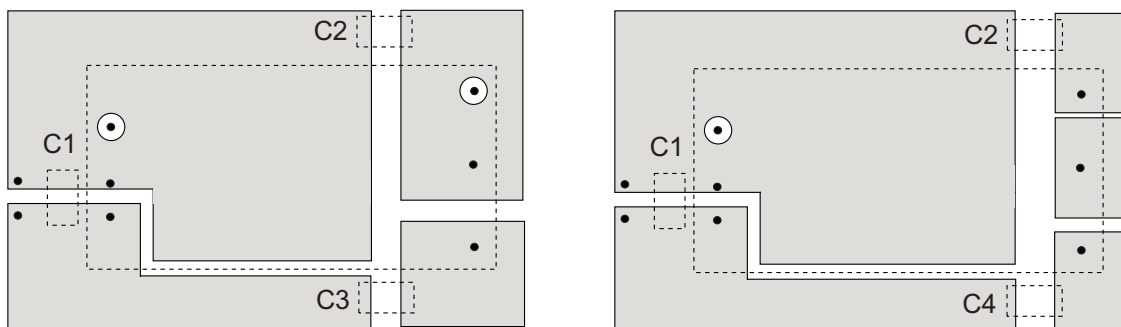

External Output Trimming

Output can be externally trimmed by using the method shown below. See Application Notes for details.

