

Features

Relays for automatic control of lighting according to ambient light level - with separate light sensor

11.31 - 1 NO 16 A output contact

- Sensitivity adjustment from 1 to 100 lux
- One module, 17.5mm wide
- Low energy consumption

11.41 - 1 CO 16 A output contact

- Patented "Zero hysteresis" for energy saving; patent pending for the "light feedback compensation" principle
- Selector with 4 positions:
 - Standard range (threshold setting 1...80 lx)
 - High range (threshold setting 30...1000 lx)
 - continuous light (helpful during installation and initial testing and for maintenance purposes)
 - light off (useful for vacations)

- For the first 3 working cycles the delay time (On and Off) is reduced to zero in order to aid installation
- LED status indication
- SELV separation between contact and supply circuit
- Double insulation between supply and light sensor
- 35 mm rail (EN 60715) mount
- Cadmium free contact material
- Cadmium free light sensor (IC photo diode)

For outline drawing see page 8

NEW 11.31



- 1 pole
- 17.5 mm wide

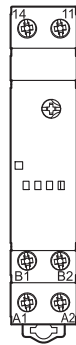

NEW 11.41



- 1 pole
- "zero hysteresis"
- 4 position selector

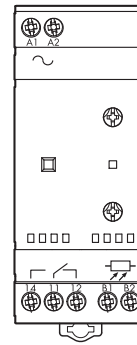

Contact specification			
Contact configuration		1 NO (SPST-NO)	1 CO (SPDT)
Rated current/Maximum peak current (I_N/I_{max}) A		16 / 30 (120 – 5 ms)	16 / 30 (120 – 5 ms)
Rated voltage/Maximum switching voltage (U_N/U_{max}) V AC		250 / 400	250 / 400
Rated load AC1 VA		4,000	4,000
Rated load AC15 (230 V AC) VA		750	750
Nominal lamp rating (230 V): incandescent W		2,000	2,000
compensated fluorescent W		750	750
uncompensated fluorescent W		1,000	1,000
halogen W		2,000	2,000
Minimum switching load mW (V/mA)		1,000 (10 / 10)	1,000 (10 / 10)
Standard contact material		AgSnO ₂	AgSnO ₂
Supply specification			
Nominal voltage (U_N) V AC (50/60 Hz)		110...230	230
	U_N DC	–	–
Rated power (P_N) VA (50 Hz)/W		2.5 / 0.9	5.2 / 2
Operating range V AC (50 Hz)		90...260	(0.8 ... 1.1) U_N
	DC	–	–
Technical data			
Electrical life at rated load in AC1 cycles		100 · 10 ³	100 · 10 ³
Threshold setting: Standard range lx		1...100	1...80
High range lx		–	30...1,000
Hysteresis (switching Off/On ratio)		1.25	1
Delay time: switching On / Off s		15 / 30	15 / 30
Ambient temperature range °C		–20...+50	–20...+50
Protection category: light dependent relay/light sensor		IP 20 / IP 54	IP 20 / IP 54
Approvals (according to type)			

Features

Relays for automatic control of lighting according to ambient light level - with separate light sensor

11.42 - 1 CO + 1 NO 12 A output contacts

- Two independent outputs with individual lux setting
- Selector with 4 positions:
 - Standard range (threshold setting 1...80 lx)
 - High range (threshold setting 20...1000 lx)
 - continuous light (helpful during installation and initial testing and for maintenance purposes)
 - light off (useful for vacations)
- For the first 6 working cycles (in total for channels 1 & 2) the delay time (On and Off) is reduced to zero in order to aid installation
- LED status indication

11.91 - 1 CO 16 A output contact (+ auxiliary output for Power Module)

- Daily time switch function - programmable to inhibit main output (for energy saving)
- Auxiliary output - directly driven by the photosensor
- Patent pending for the "light feedback compensation" principle
- Sensitivity adjustment from 2 to 150 lux
- LCD status indication, set-up and programming
- Internal battery for set-up/programming without supply and for time/program back-up in case of power failure

- SELV separation between contact and supply circuit
- Double insulation between supply and light sensor
- 35 mm rail (EN 60715) mount
- Cadmium free contact material
- Cadmium free light sensor (IC photo diode)

* 11.91 auxiliary output: 12 V DC, 1 W max
For outline drawing see page 8

NEW 11.42



- 2 independent outputs
- 2 individual lux settings
- 4 position selector

NEW 11.91



- Light dependent relay + time switch
- Auxiliary output (light dependent) with 19.91 power module available

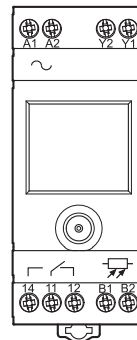
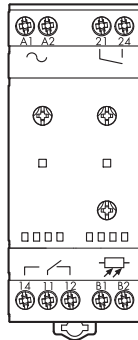

Contact specification			
Contact configuration		1 CO (SPDT) + 1 NO (SPST-NO)	1 CO (SPDT) + 1 aux output*
Rated current/Maximum peak current (I_N/I_{max}) A		12 / 24 (120 – 5 ms)	16 / 30 (120 – 5 ms)
Rated voltage/Maximum switching voltage (U_N/U_{max}) V AC		250 / 400	250 / 400
Rated load AC1	VA	3,000	4,000
Rated load AC15 (230 V AC)	VA	750	750
Nominal lamp rating (230 V):	incandescent W	2,000	2,000
	compensated fluorescent W	750	750
	uncompensated fluorescent W	1,000	1,000
	halogen W	2,000	2,000
Minimum switching load	mW (V/mA)	1,000 (10 / 10)	1,000 (10 / 10)
Standard contact material		AgSnO ₂	AgSnO ₂
Supply specification			
Nominal voltage	(U_N) V AC (50/60 Hz)	230	230
	U_N DC	–	–
Rated power	(P_N) VA (50 Hz)/W	7.4 / 2.8	6.6 / 2.9
Operating range	V AC (50 Hz)	(0.8 ... 1.1) U_N	(0.8 ... 1.1) U_N
	DC	–	–
Technical data			
Electrical life at rated load in AC1	cycles	100 · 10 ³	100 · 10 ³
Threshold setting:	Standard range lx	1...80	2...150
	High range lx	20...1,000	–
Hysteresis (switching Off/On ratio)		1.25	$\Delta = 3$ lx
Delay time: switching On / Off	s	15 / 30	25 / 50
Ambient temperature range	°C	–20...+50	–20 ... + 50
Protection category: light dependent relay/light sensor		IP 20 / IP 54	IP 20 / IP 54
Approvals (according to type)			

Ordering information

Example: 11 series light dependent relay with time switch, 1 CO (SPDT) 16 A contact, 230 V AC supply.

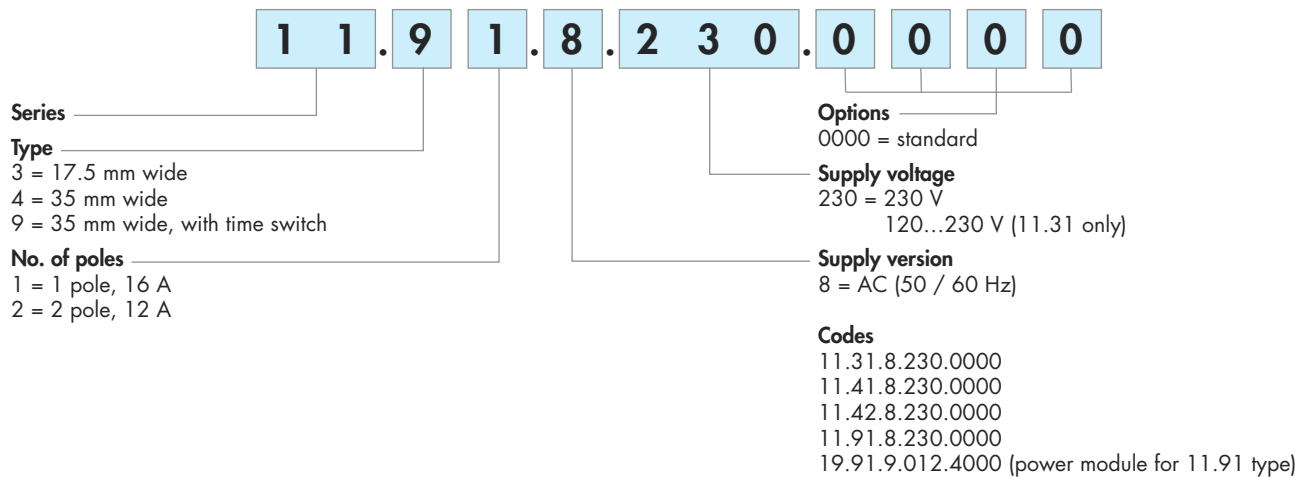

Technical data

Insulation		Dielectric strength	Impulse (1.2/50 μs)		
	between supply and contacts	4,000 V AC	6 kV		
	between supply and light sensor	2,000 V AC	4 kV		
	between open contacts	1,000 V AC	1.5 kV		
EMC specifications					
Type of test		Reference standard	11.31	11.41 / 42 / 91	
Electrostatic discharge	contact discharge	EN 61000-4-2	4 kV		
	air discharge	EN 61000-4-2	8 kV		
Radiated electromagnetic field (80 ... 1000 MHz)		EN 61000-4-3	10 V/m		
Fast transients (burst 5/50 ns, 5 and 100 kHz)	on supply terminals	EN 61000-4-4	3 kV	4 kV	
	on light sensor connection	EN 61000-4-4	3 kV	4 kV	
Voltage pulses on supply terminals (surge 1.2/50 μs)	common mode	EN 61000-4-5	4 kV		
	differential mode	EN 61000-4-5	3 kV	4 kV	
Radiofrequency common mode voltage (0.15...80 MHz)	on supply terminals	EN 61000-4-6	10 V		
	on light sensor	EN 61000-4-6	3 V		
Voltage dips	70 % U _N , 40 % U _N	EN 61000-4-11	10 cycles		
Short interruptions		EN 61000-4-11	10 cycles		
Radio frequency conducted emissions	0.15...30 MHz	EN 55014	class B		
Radiated emissions	30...1000 MHz	EN 55014	class B		
Terminals					
Screw torque		0.8 Nm			
Max. wire size	solid cable	1 x 6 / 2 x 4 mm ²	1 x 10 / 2 x 12 AWG		
	stranded cable	1 x 4 / 2 x 2.5 mm ²	1 x 12 / 2 x 14 AWG		
Wire strip length		9 mm			
Other data					
Cable grip of light sensor		7.5 ...9 mm			
Maximum cable length relay to light sensor		50 m (2 x 1.5 mm ²)			
Preset threshold		10 lx			
Power lost to the environment		11.31	11.41	11.42	11.91
	in stand-by	0.3 W	1.3 W	1.4 W	1.4 W
	without contact current	0.9 W	2.0 W	2.8 W	2.9 W
	with rated current	1.7 W	2.6 W	3.8 W	3.5 W

Wiring diagrams

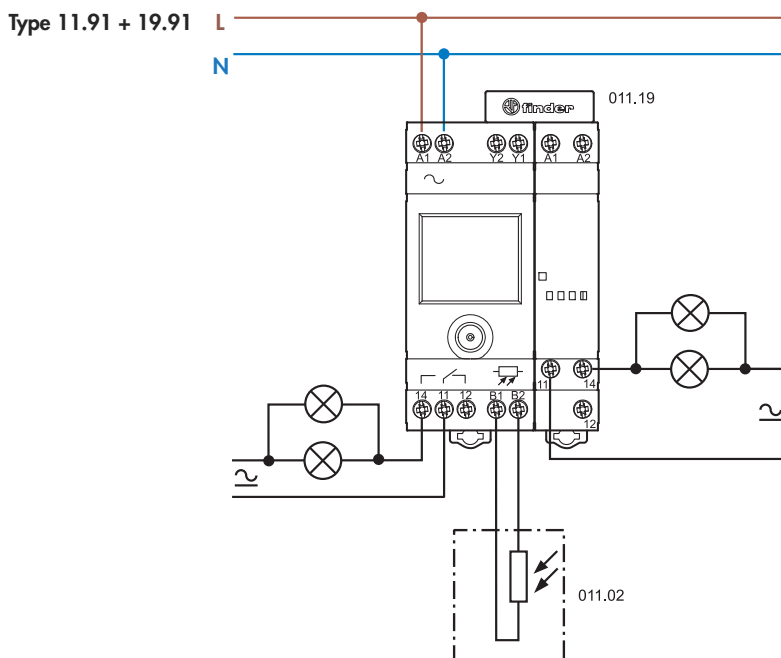
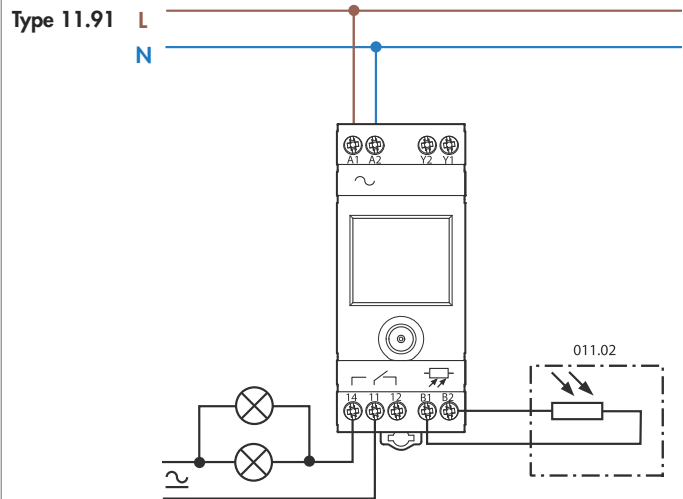
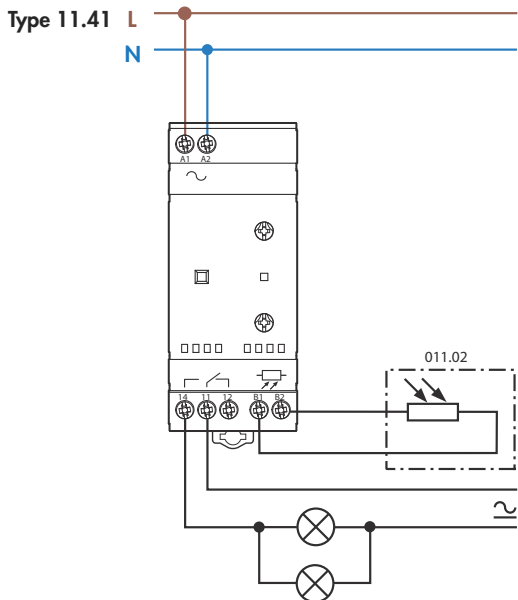
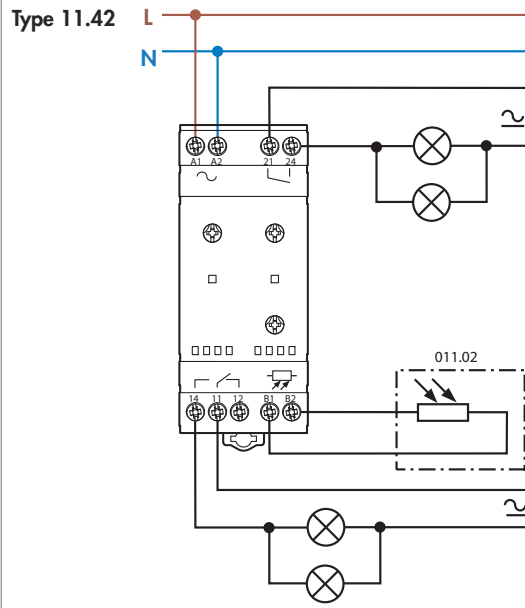
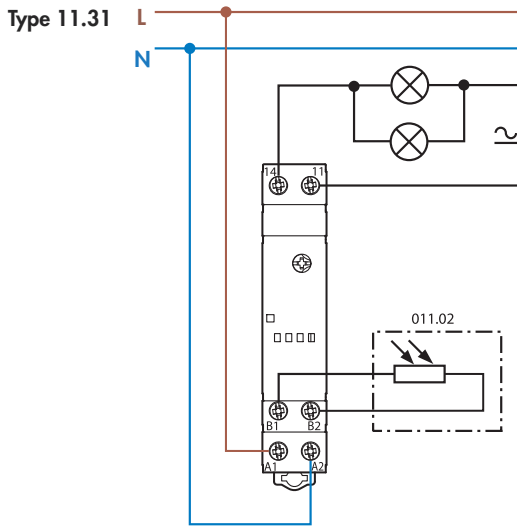

Advantage of the "Zero hysteresis" patented circuit:

ensures reliable switching without wasting energy

TYPE 11.41 "ZERO HYSTERESIS" LIGHT DEPENDENT RELAYS

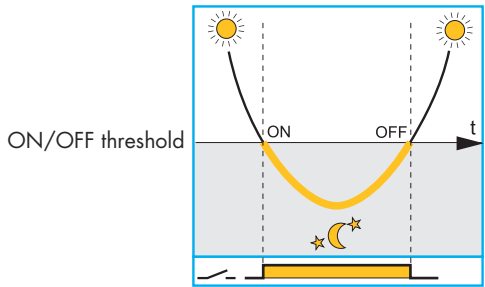

Switch OFF level = Switch ON level. Patented "Zero Hysteresis" circuitry ensures reliable switching without wasting energy.

TRADITIONAL LIGHT DEPENDENT RELAYS

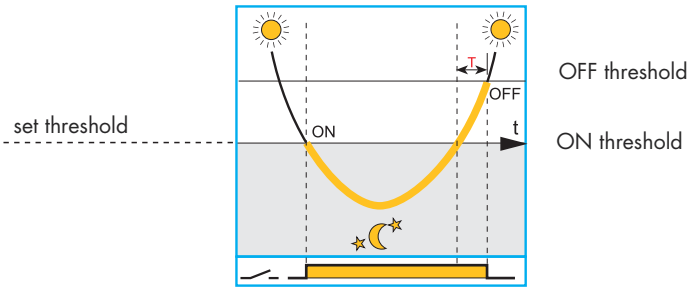

"Traditional" light dependent relays incorporate switching hysteresis to prevent malfunctioning or tripping. This results in an unnecessary delay in switching off, and a resulting waste of energy (over period T).

- Brightness of the natural light
- The NO of the light dependent relay is closed (light is switched on)

Advantage of the "light feedback compensation" patent pending principle:

avoids the effect of the lamps repeatedly "hunting" between On and Off, due to poor installation

Light dependent relay where the lighting being controlled does not influence the light level seen by the light sensor

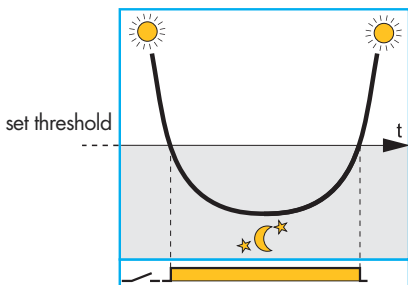

Correct functioning - provided the light sensor can be shielded from the effects of the controlled lighting switching On and Off

Traditional light dependent relay where the lighting being controlled influences the light level seen by the light sensor

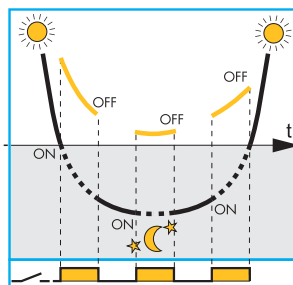

Incorrect functioning where the lamps cycle between On and Off, because their effect is being detected by the light sensor

Type 11.41 and 11.91 light dependent relay with "light feedback compensation"

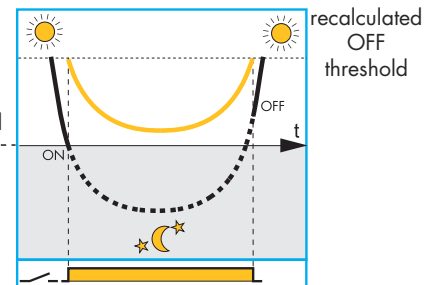

The innovative principle of "light feedback compensation" avoids the annoying and damaging effects of the lamps repeatedly "hunting" between On and Off, due to poor installation

- Ambient light level as measured by the light dependent relay's light sensor.
- Ambient light + controlled light level as measured by the light dependent relay's light sensor.

Notes

1. It is good practice to try to achieve a correct installation where the light emitted from the lamp(s) does not influence the light level seen by the light sensor, although the "light feedback compensation" principle will help when this is not fully achievable. In this case it should be appreciated that the "light feedback compensation" principle may delay slightly the time of Switch Off - beyond the ideal.
2. The compensation principle is not effective where the combined effect of the ambient light and the controlled lighting exceeds a maximum value (200 lux for the 11.91, 160/2,000 lux for standard/high range of the 11.41).
3. The 11.41 and 11.91 types are compatible with gas discharge lamps that attain full output within 10 minutes, since the electronic circuit monitors lamps' light output over a 10 minute period to achieve a true assessment of its contribution to the overall lighting level.

Functions 11.91

	Switch-OFF time	Switch-ON time		Application examples
	NO	NO		Working as a standard light-dependent relay
11 14	YES	NO		Working where lighting is not required from 10 PM onwards
	YES	YES		Working where lighting is not required between 1 AM and 5 AM
AUX Y1 Y2				Additional output - light dependent without time switch intervention

All the functions and the values can be set through the front joystick and are displayed on the front LCD.



Display mode

During normal operation, with AC supply connected, the following is displayed:

- the current time
- the current lux level (upper bars)
- the set lux threshold (lower bars)
- the status (open/closed) of the 11-14 output contact
- the "moon" symbol (only if the current lux level is lower than the set threshold). It also indicates that the Auxiliary output is On, although the main output contact 11-14 may be On, depending on the chrono program.
- the "chrono" symbol (only if a switch-off time is enabled).

From **Display mode** it is possible to enter **Program mode** or **Set-up mode** with a short or long (> 2s) press respectively, to the joystick centre. From **Display mode** it is also possible to enter **Hand mode**, where (independently of the lux level and the Chrono program) the 11-14 output contact is forced into the On or Off position with a long (> 2s) press of the joystick upper or lower quadrants, respectively. The "hand" symbol is then displayed. A long press to the opposite quadrant will reset the hand mode.

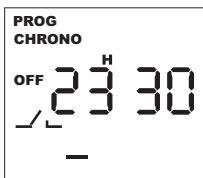

Program mode

In this mode it is possible to set the lux threshold level, to enable and to set the switch-off time, to enable and to set the switch-on time. With a short press to the joystick right or left quadrant it is possible to progress from one program step to another (accepting the values set). At any program step it is possible to modify the set values with a short press to the joystick upper or lower quadrant. A long (> 1s) press allows the fast increment (or decrement) of values. A short press to the joystick centre will resume the display mode.

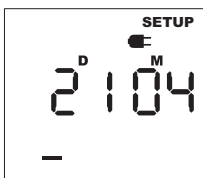

Set-up mode

In this mode it is possible to set the current year, month, day, hour and minute (in this order) and to enable european "Daylight saving".

With a short press to the joystick right or left quadrant it is possible to progress from one set-up step to another (accepting the values set); in any step it is possible to modify the set values with a short press to the joystick upper or lower quadrant. A long (> 1s) press allows the fast increment (or decrement) of values.

A short press to the joystick centre will resume the display mode.

Note: the product is supplied with central european time factory set and "Daylight saving" enabled.

Power-off mode

If the 230 V AC supply is not connected, the relay enters power-off mode and to ensure the long life of the built-in back-up battery only the clock is maintained active. The display turns off and no other operation (including light measurement) is performed.

With a press to the joystick during power-off mode it is possible to "awaken" the device and to enter program or set-up mode (the "electrical plug" symbol is displayed); after about 1 minute inactivity the power-off mode is resumed.

Note: with the supply not connected, the program or set-up modes absorb a higher current than the power-off mode, thus influencing the battery life.







Auxiliary output

A solid state output at terminals Y1-Y2 is provided (rated 12 V DC, 80 mA 1 W max.): this can be used with the power module **19.91.9.012.4000** connected by the dedicated **011.19** connector. Or, it is possible to connect a suitable relay (for example, 38-48-49-4C-58-59 interface module) provided the coil is within the rating, and the wiring does not exceed 40 cm length. The auxiliary output is driven exclusively by the light sensor of the device, and is consequently independent of the time switch. With the main contact, this permits a flexible lighting system controlled by the ambient light, both with and without the influence of the time switch function.



19.91 power module specification		
Contact configuration		1 CO (SPDT)
Rated current/Maximum peak current	I_N/I_{max}	16 / 30 A (120 A – 5 ms)
Rated voltage/Maximum switching voltage	U_N/U_{max}	250 / 400 V AC
Rated load AC15 (230 VAC)		750 VA
Nominal lamp rating (230 V):	incandescent	2,000 W
	compensated fluorescent	750 W
Nominal supply voltage	U_N	12 V DC
Ambient temperature range		-20...+50 °C
Protection category		IP 20

11.31/41/42

LED	Supply voltage	NO output contact	
		11.41 / 11.42	11.31
	OFF	Open	Open
	ON	Open	Open
	ON	Open (timing to close in progress)	Open (timing to close in progress)
	ON	Closed	Closed
	ON	Closed (timing to open in progress)	Closed (timing to open in progress)
	ON	Fixed position (On or Off on selector)	—

Outline drawings

11.31
Screw terminal

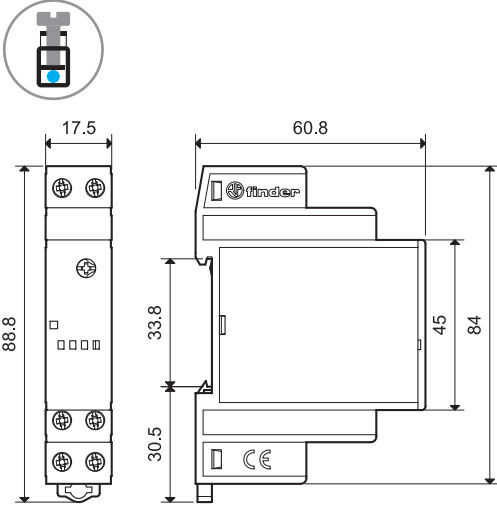

11.42
Screw terminal

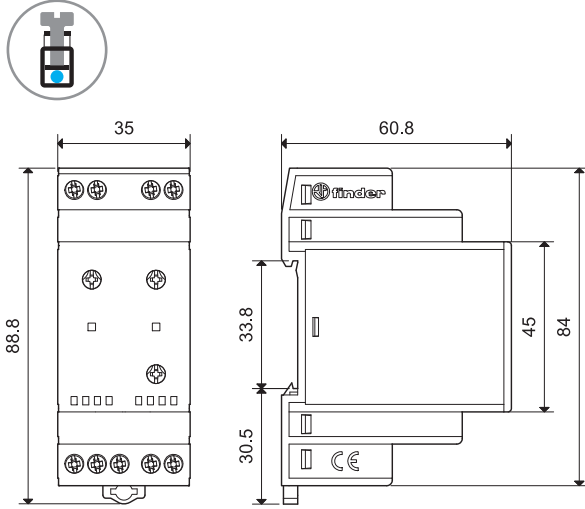

11.41
Screw terminal

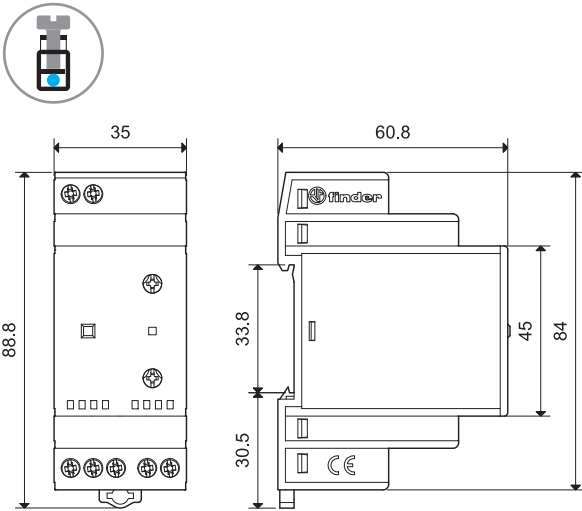

11.91
Screw terminal

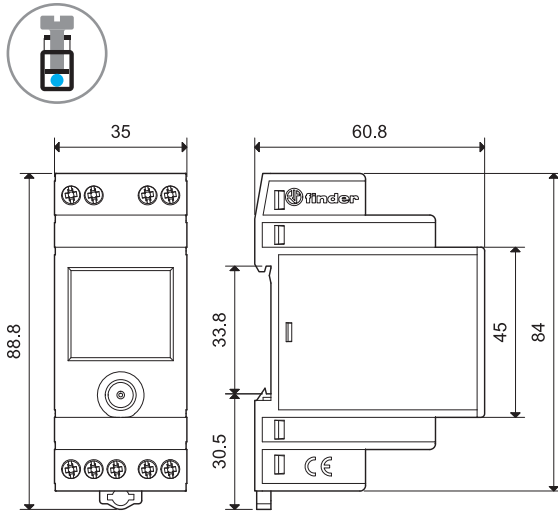

19.91 (power module for 11.91)
Screw terminal

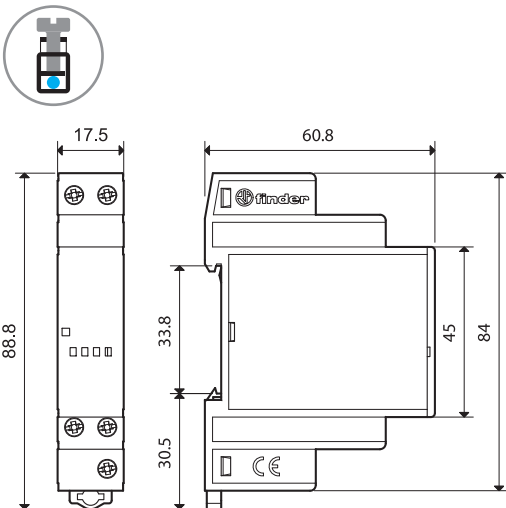

11.91 + 19.91 power module
Screw terminal

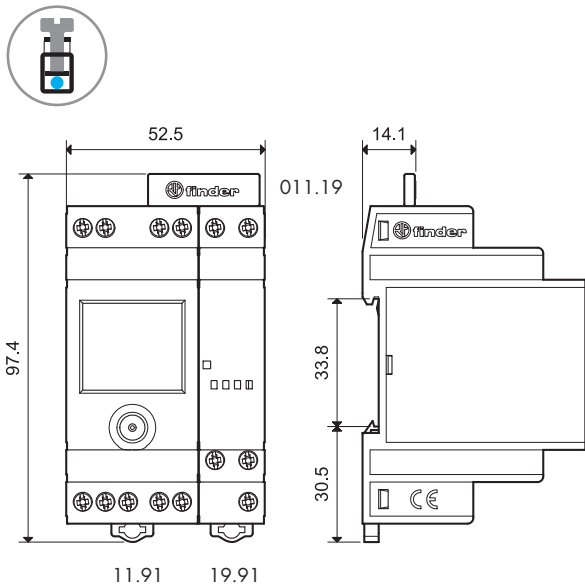

Accessories



011.02

Light sensor (supplied with light dependent relay)	011.02
<ul style="list-style-type: none"> - Cadmium free - Non polarized - Double insulated with respect to light dependent relay supply - Not compatible with old 11.01 and 11.71 light dependent relay (to be used with 011.00 photosensor) 	

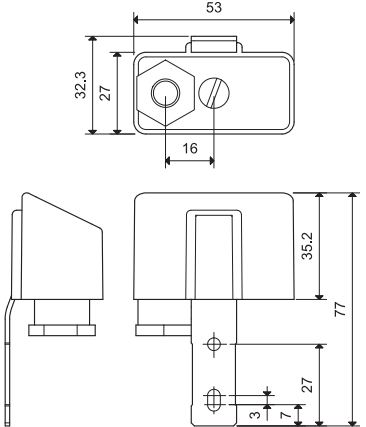

011.03

Flush-mounted light sensor (protection category: IP65)	011.03
<ul style="list-style-type: none"> - Cable length: 500 mm - Cadmium free - Non polarized - Double insulated with respect to light dependent relay supply - Not compatible with old 11.01 and 11.71 light dependent relay 	

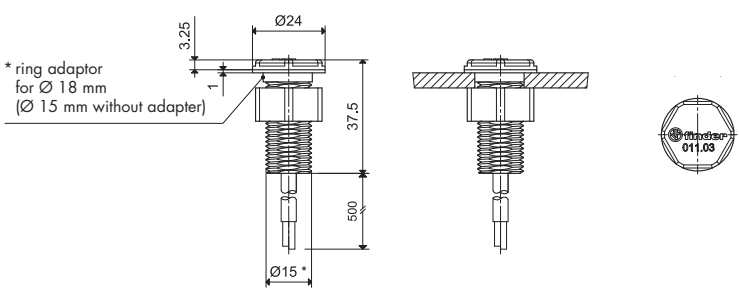

011.01

Adaptor for panel mounting (supplied with light dependent relay), 35 mm wide	011.01
---	--------

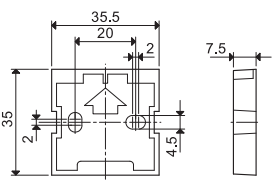

011.19

2-pole connector (for type 11.91 and 19.91 power module)	011.19
---	--------

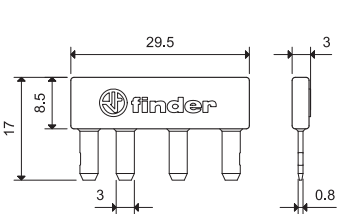

For direct connection of 11.91 auxiliary output (Y1-Y2) to 19.91 supply (A1-A2)

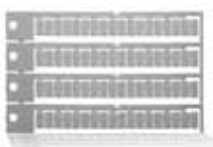
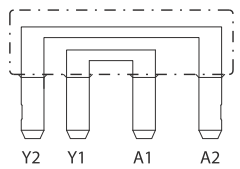

060.72

Sheet of marker tags , for types 11.31, 11.41, 11.42, 19.91, plastic, 72 tags, 6x12 mm	060.72
---	--------



019.01

Identification tag , for types 11.41 and 11.42, plastic, 1 tag, 17x25.5 mm	019.01
---	--------

