

## Features

- 1 & 2 Pole - Low profile (15.7 mm height)  
 41.31 - 1 Pole 12 A (3.5 mm pin pitch)  
 41.52 - 2 Pole 8 A (5 mm pin pitch)  
 41.61 - 1 Pole 16 A (5 mm pin pitch)

### PCB mount

- direct or via PCB socket
- 35 mm rail mount
- via screw and screwless sockets

- DC coils - 400 mW
- 8 mm, 6 kV (1.2/50 μs) isolation, coil-contacts
- Cadmium Free contact materials
- Flux proof: RT II standard, (RT III option)

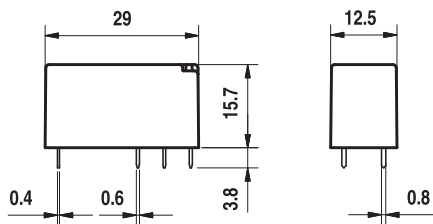

FOR UL HORSEPOWER AND PILOT DUTY RATINGS  
 SEE "General technical information" page V

### NEW 41.31



- 3.5 mm contact pin pitch
- 1 Pole 12 A
- PCB direct or via socket

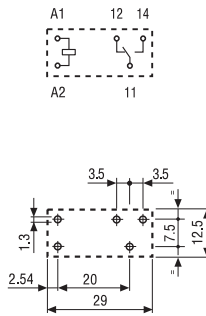

Copper side view

### NEW 41.52



- 5 mm contact pin pitch
- 2 Pole 8 A
- PCB direct or via socket

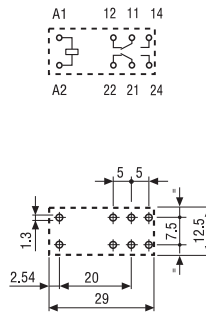

Copper side view

### NEW 41.61



- 5 mm contact pin pitch
- 1 Pole 16 A
- PCB direct or via socket

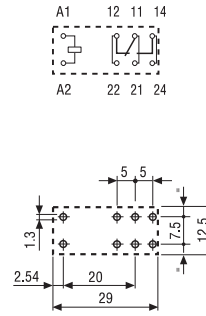

Copper side view

Contact specification				
Contact configuration		1 CO (SPDT)	2 CO (DPDT)	1 CO (SPDT)
Rated current/Maximum peak current	A	12/25	8/15	16/30
Rated voltage/Maximum switching voltage	V AC	250/400	250/400	250/400
Rated load AC1	VA	3,000	2,000	4,000
Rated load AC15 (230 V AC)	VA	600	400	750
Single phase motor rating (230 V AC)	kW	0.5	0.3	0.5
Breaking capacity DC1: 30/110/220 V	A	12/0.3/0.12	8/0.3/0.12	16/0.3/0.12
Minimum switching load	mW (V/mA)	300 (5/5)	300 (5/5)	300 (5/5)
Standard contact material		AgNi	AgNi	AgNi
Coil specification				
Nominal voltage (U <sub>N</sub> )	V AC (50/60 Hz)	—	—	—
	V DC	12 - 24 - 48 - 60 - 110	12 - 24 - 48 - 60 - 110	12 - 24 - 48 - 60 - 110
Rated power AC/DC	VA (50 Hz)/W	—/0.4	—/0.4	—/0.4
Operating range	AC	—	—	—
	DC	(0.7...1.5)U <sub>N</sub>	(0.7...1.5)U <sub>N</sub>	(0.7...1.5)U <sub>N</sub>
Holding voltage	AC/DC	—/0.4U <sub>N</sub>	—/0.4 U <sub>N</sub>	—/0.4 U <sub>N</sub>
Must drop-out voltage	AC/DC	—/0.1U <sub>N</sub>	—/0.1 U <sub>N</sub>	—/0.1 U <sub>N</sub>
Technical data				
Mechanical life AC/DC	cycles	—/30·10 <sup>6</sup>	—/30·10 <sup>6</sup>	—/30·10 <sup>6</sup>
Electrical life at rated load AC1	cycles	150 · 10 <sup>3</sup>	80 · 10 <sup>3</sup>	70 · 10 <sup>3</sup>
Operate/release time	ms	5/4	5/4	5/4
Insulation between coil and contacts (1.2/50 μs)	kV	6 (8 mm)	6 (8 mm)	6 (8 mm)
Dielectric strength between open contacts	V AC	1,000	1,000	1,000
Ambient temperature range	°C	−40...+85	−40...+85	−40...+85
Environmental protection		RT II	RT II	RT II

Approvals (according to type)

## Features

### Solid State Relays

#### Printed circuit mount:

- direct or via PCB socket

#### 35 mm rail mount:

- via screw or screwless sockets

- Single circuit output switching options
  - 5 A 24 V DC
  - 3 A 240 V AC
- Silent, high speed switching with long electrical life
- Low profile (15.7 mm)
- Wash tight: RT III
- 2,500 V insulation, input-output

### NEW 41.81 - 9024



- 5 A, 24 V DC output switching
- PCB or 93 Series sockets

### NEW 41.81 - 8240



- 3 A, 240 V AC output switching
- Zero crossing switching
- PCB or 93 Series sockets

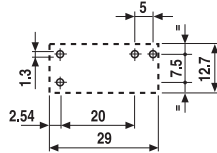
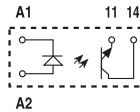
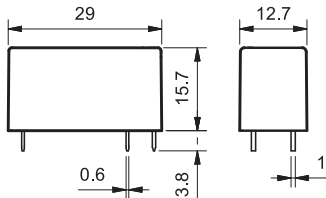

Copper side view

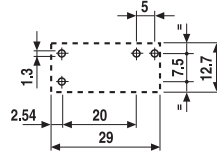
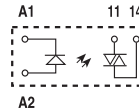

Copper side view

Output circuit			
Contact configuration		1 NO (SPST-NO)	1 NO (SPST-NO)
Rated current/Maximum peak current (100 µs)A		5/40	3/40
Rated voltage/Maximum blocking voltage	V	(24/35)DC	(240/275)AC
Switching voltage range	V	(1.5...35)DC	(12...275)AC
Minimum switching current	mA	1	50
Max. "OFF-state" leakage current	mA	0.01	1
Max. "ON-state" voltage drop	V	0.3	1.1
Input circuit			
Nominal voltage	V DC	24	24
Operating range	V DC	10...32	10...32
Control current	mA	9	9
Release voltage	V DC	9	9
Impedance	Ω	2,600	2,600
Technical data			
Operate/release time	ms	0.05/0.25	10/10
Dielectric strength between input/output	V	2,500	2,500
Ambient temperature range	°C	-20...+60	-20...+60
Environmental protection		RT III	RT III
Approvals (according to type)			

## Ordering information

### Electromechanical relay (EMR)

Example: 41 series low-profile PCB relay, 2 CO (DPDT), 24 V DC coil.

**4 1 . 5 2 . 9 . 0 2 4 . 0 0 1 0**

A      B      C      D

**Series** ————

**Type** ————  
 3 = PCB - 3.5 mm pinning  
 5 = PCB - 5 mm pinning  
 6 = PCB - 5 mm pinning

**No. of poles** ————  
 1 = 1 pole for  
     41.31, 12 A  
     41.61, 16 A  
 2 = 2 pole for  
     41.52, 8 A

**Coil version** ————  
 9 = DC

**Coil voltage** ————  
 See coil specifications

**A: Contact material**  
 0 = Standard AgNi  
 4 = AgSnO<sub>2</sub>  
 5 = AgNi + Au (5 µm)

**B: Contact circuit**  
 0 = CO (nPDT)  
 3 = NO (nPST)

**C: Options**  
 1 = None

**D: Special versions**  
 0 = Flux proof (RT II)  
 1 = Wash tight (RT III)

**Selecting features and options: only combinations in the same row are possible.**  
 Preferred selections for best availability are shown in **bold**.

Type	Coil version	A	B	C	D
41.31	DC	<b>0</b> - 4 - 5	<b>0</b> - 3	<b>1</b>	<b>0</b> - 1
41.52	DC	<b>0</b> - 5	<b>0</b> - 3	<b>1</b>	<b>0</b> - 1
41.61	DC	<b>0</b> - 4	<b>0</b> - 3	<b>1</b>	<b>0</b> - 1

### Solid state relay (SSR)

Example: 41 series SSR relay, 5 A output, 24 V DC supply.

**4 1 . 8 1 . 7 . 0 2 4 . 9 0 2 4**

**Series** ————

**Type** ————  
 8 = SSR type

**Output** ————  
 1 = 1 NO (SPST-NO)

**Input circuit** ————  
 See input specifications

**Output circuit**  
 9024 = 5 A - 24 V DC  
 8240 = 3 A - 240 V AC

## Electromechanical relay

### Technical data

Insulation according to EN 61810-1					
		1 pole		2 pole	
Nominal voltage of supply system	V AC	230/400		230/400	
Rated insulation voltage	V AC	250	400	250	400
Pollution degree		3	2	3	2
<b>Insulation between coil and contact set</b>					
Type of insulation		Reinforced (8 mm)		Reinforced (8 mm)	
Overvoltage category		III		III	
Rated impulse voltage	kV (1.2/50 µs)	6		6	
Dielectric strength	V AC	4,000		4,000	
<b>Insulation between adjacent contacts</b>					
Type of insulation		—		Basic	
Overvoltage category		—		III	
Rated impulse voltage	kV (1.2/50 µs)	—		4	
Dielectric strength	V AC	—		2,000	
<b>Insulation between open contacts</b>					
Type of disconnection		Micro-disconnection		Micro-disconnection	
Dielectric strength	V AC/kV (1.2/50 µs)	1,000/1.5		1,000/1.5	
<b>Conducted disturbance immunity</b>					
Burst (5...50)ns, 5 kHz, on A1 - A2		EN 61000-4-4		level 4 (4 kV)	
Surge (1.2/50 µs) on A1 - A2 (differential mode)		EN 61000-4-5		level 3 (2 kV)	
<b>Other data</b>					
Bounce time: NO/NC	ms	2/5			
Vibration resistance (5...55)Hz: NO/NC	g	15/2			
Shock resistance	g	16			
Power lost to the environment	without contact current	W	0.4		
	with rated current	W	1.7 (41.31)	1.2 (41.52)	1.8 (41.61)
Recommended distance between relays mounted on PCB	mm	≥ 5			

## Contact specification

**F 41 - Electrical life (AC) v contact current**  
Types 41.31/61

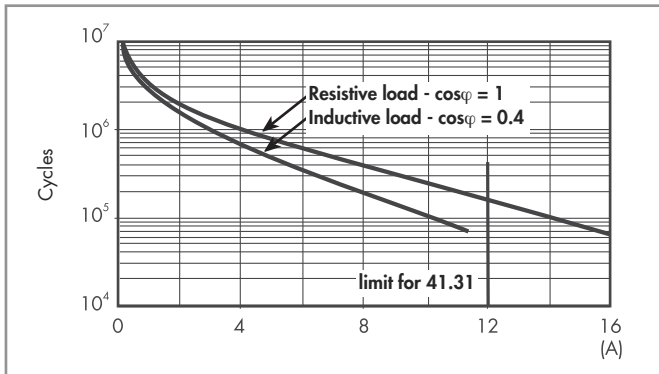

**F 41 - Electrical life (AC) v contact current**  
Type 41.52

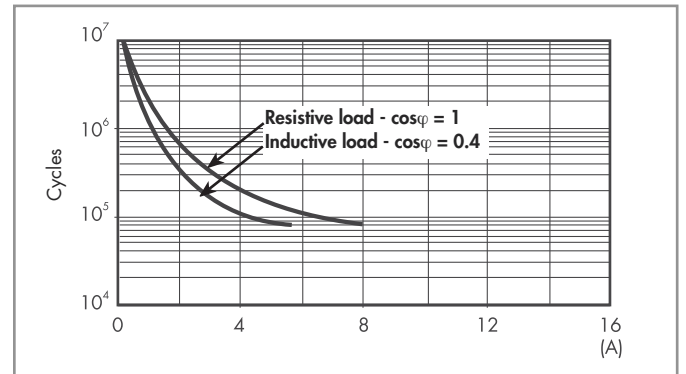

**H 41- Maximum DC1 breaking capacity**

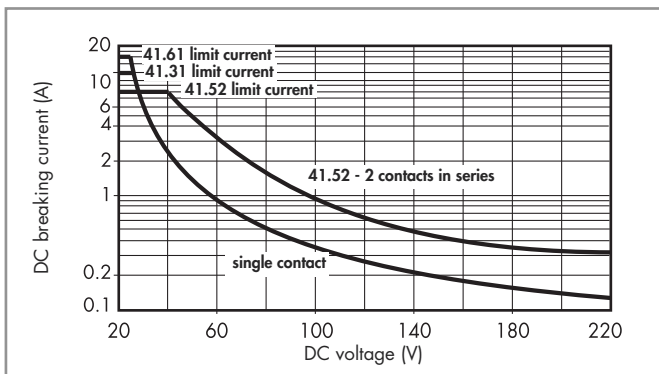

- When switching a resistive load (DC1) having voltage and current values under the curve, an electrical life of  $\geq 100 \cdot 10^3$  can be expected.
- In the case of DC13 loads, the connection of a diode in parallel with the load will permit a similar electrical life as for a DC1 load.  
Note: the release time for the load will be increased.

## Coil specifications

### DC coil data

Nominal voltage $U_N$ V	Coil code	Operating range		Resistance R $\Omega$	Rated coil consumption I at $U_N$ mA
		$U_{min}$ V	$U_{max}$ V		
12	9.012	8.4	18	360	33.3
24	9.024	16.8	36	1,440	16.7
48	9.048	33.6	72	5,760	8.3
60	9.060	42	90	9,000	6.6
110	9.110	77	165	24,200	4.5

**R 41 - DC coil operating range v ambient temperature**

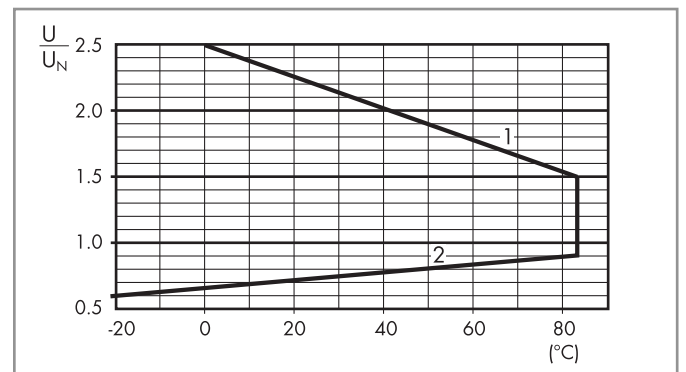

- 1 - Max. permitted coil voltage.
- 2 - Min. pick-up voltage with coil at ambient temperature.

## Solid state relay

### Technical data

Other data		41.81 - 9024	41.81 - 8240
Power lost to the environment	without current	W	0.25
	with maximum current	W	1.75

### Input specification

#### Input data - DC types

Nominal voltage $U_N$ V	Input code	Operating range		Release voltage V	Impedance $\Omega$	Control current I at $U_N$ mA
		$U_{min}$ V	$U_{max}$ V			
24	7.024	10	32	9	2,600	9

### Output specification

**L 41 - Output current v ambient temperature**  
SSR - 5 A DC output types

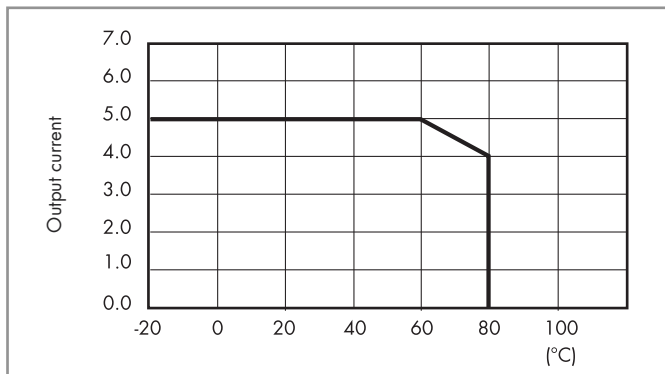

**L 41 - Output current v ambient temperature**  
SSR - 3 A AC output types

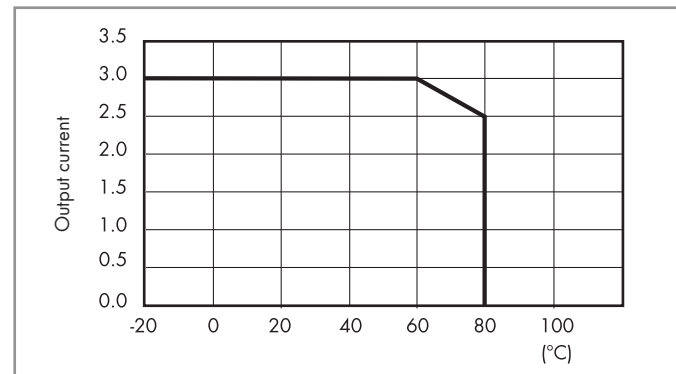



93.02

Approvals  
(according to type):



**Screw terminal socket 35 mm (EN 60715) mounting**

Supply voltage	Relay type	Socket type
6 V AC/DC	41.52.9.005.0010	93.02.0.024
12 V AC/DC	41.52.9.012.0010	93.02.0.024
24 V AC/DC	41.52.9.024.0010	93.02.0.024
60 V AC/DC	41.52.9.060.0010	93.02.0.060
(110...125)V AC/DC	41.52.9.110.0010	93.02.0.125
(220...240)V AC/DC	41.52.9.110.0010	93.02.0.240
6 V DC	41.52.9.005.0010	93.02.7.024
12 V DC	41.52.9.012.0010	93.02.7.024
24 V DC	41.52.9.024.0010 or 41.81.7.024.xxxx	93.02.7.024
48 V DC	41.52.9.048.0010	93.02.7.060
60 V DC	41.52.9.060.0010	93.02.7.060

**Accessories**

8-way jumper link	093.08 (see specification next page)
Plastic separator	093.01 (see specification next page)
Sheet of marker tags, 72 tags	090.72 (see specification next page)

**Technical data**

Rated values	10 A - 250 V	
Dielectric strength	6 kV (1.2/50 μs) between coil and contacts	
Protection category	IP 20	
Ambient temperature	°C (-40...+70)°C - (U <sub>N</sub> ≤ 60 V DC), (-40...+55)°C - (U <sub>N</sub> > 60 V DC)	
⊕ Screw torque	Nm	0.5
Wire strip length	mm	8
Max. wire size for 93.02 socket	solid wire	stranded wire
	mm <sup>2</sup>	1x6 / 2x2.5
	AWG	1x10 / 2x14

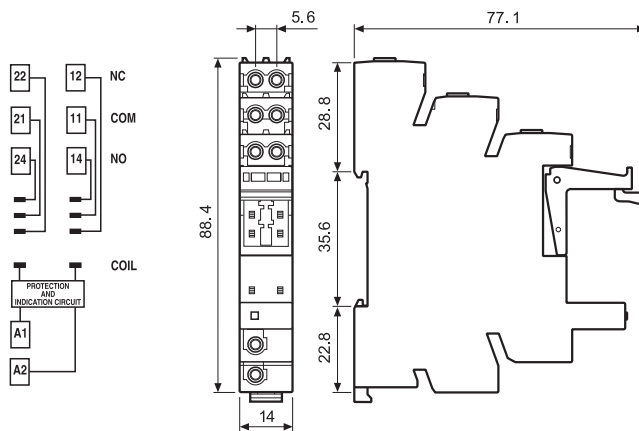



93.52

Approvals  
(according to type):

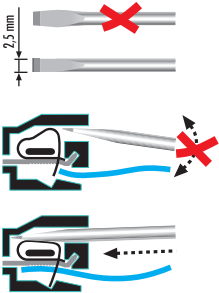

### Screwless terminal socket 35 mm (EN 60715) mounting

Supply voltage	Relay type	Socket type
6 V AC/DC	41.52.9.005.0010	93.52.0.024
12 V AC/DC	41.52.9.012.0010	93.52.0.024
24 V AC/DC	41.52.9.024.0010	93.52.0.024
60 V AC/DC	41.52.9.060.0010	93.52.0.060
(110...125)V AC/DC	41.52.9.110.0010	93.52.0.125
(220...240)V AC/DC	41.52.9.110.0010	93.52.0.240
6 V DC	41.52.9.005.0010	93.52.7.024
12 V DC	41.52.9.012.0010	93.52.7.024
24 V DC	41.52.9.024.0010 or 41.81.7.024.xxxx	93.52.7.024
48 V DC	41.52.9.048.0010	93.52.7.060
60 V DC	41.52.9.060.0010	93.52.7.060

### Accessories

8-way jumper link	093.08 (see table below)
Plastic separator	093.01 (see table below)
Sheet of marker tags, 72 tags	090.72 (see table below)

### Technical data

Rated values	10 A - 250 V		
Dielectric strength	6 kV (1.2/50 μs) between coil and contacts		
Protection category	IP 20		
Ambient temperature	°C (-40...+70)°C - (U <sub>N</sub> ≤ 60 V DC), (-40...+55)°C - (U <sub>N</sub> > 60 V DC)		
Wire strip length	mm	8	
Max. wire size for 93.52 socket	solid wire	stranded wire	
	mm <sup>2</sup>	1x2.5	1x2.5
	AWG	1x14	1x14

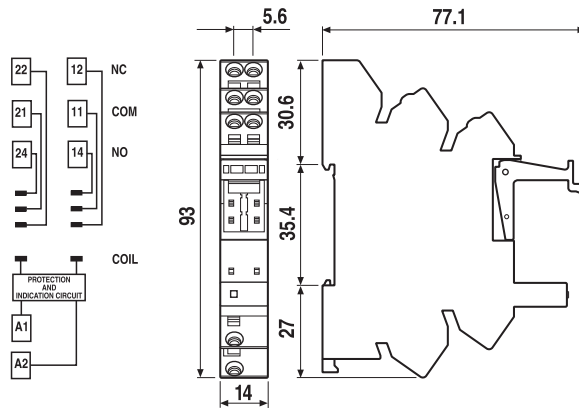

## Accessories



093.08

Approvals  
(according to type):



<b>8-way jumper link</b> for 93.02 and 93.52 sockets	093.08 (blue)	093.08.0 (black)
Rated values	10 A - 250 V	

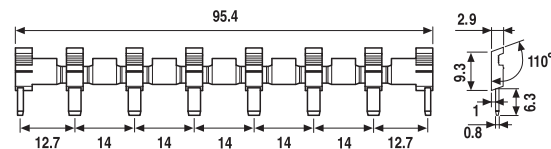

093.01

<b>Plastic separator</b> for 93.02 and 93.52 sockets	093.01
--	--------

Thickness 2 mm, required at the start and the end of a group of interfaces.

Can be used for visual separation group, must be used for:

- protective separation of different voltages of neighbouring PLC interfaces according to VDE 0106-101
- protection of cut jumper links

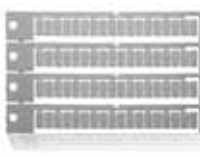

060.72

<b>Sheet of marker tags</b> for 38.x2, plastic, 72 tags, 6x12 mm	060.72
--	--------





95.13.2



95.15.2

Approvals  
(according to type):



PCB socket	95.13.2 (blue)	95.13.20 (black)	95.15.2 (blue)	95.15.20 (black)
For relay type	41.31		41.52, 41.61, 41.81 <sup>(1)</sup>	
<b>Accessories</b>				
Plastic retaining clip				095.42
<b>Technical data</b>				
Rated values	10 A - 250 V *			
Dielectric strength	6 kV (1.2/50 μs) between coil and contacts			
Protection category	IP 20			
Ambient temperature	°C -40...+70			

\* For currents >10 A, contact terminals must be connected in parallel (21 with 11, 24 with 14, 22 with 12).

<sup>(1)</sup> With the relay 41.81 the NO change-over contact will be 11-14.

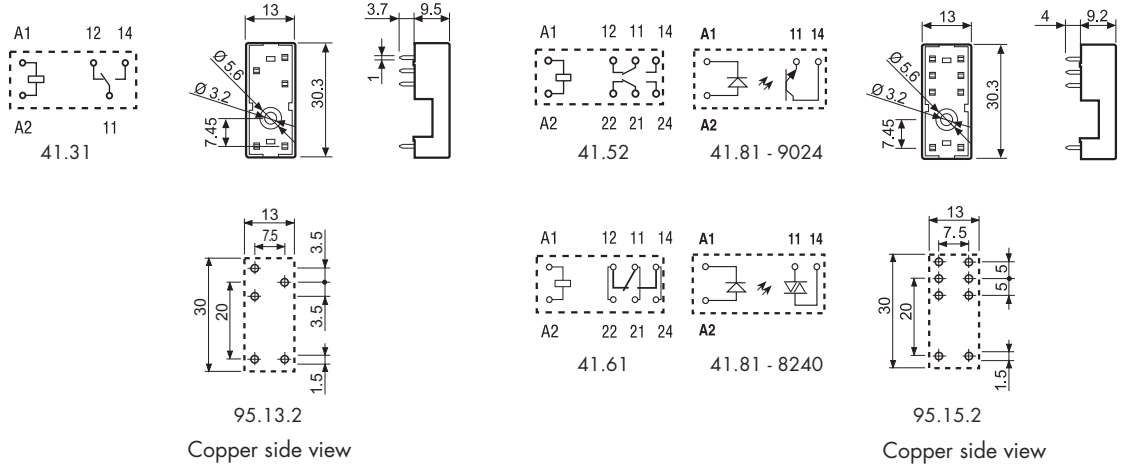

## Packaging codes

How to code and identify retaining clip and packaging options for sockets.

Example:



A Standard packaging

SL Plastic retaining clip



Without retaining clip

