

CMS3005

Highly Dynamic MagnetoResistive Current Sensor ($I_{PN} = 5\text{ A}$)

Data sheet

The CMS3000 current sensor family is designed for highly dynamic electronic measurement of DC, AC, pulsed and mixed currents with integrated galvanic isolation. The MagnetoResistive technology enables an excellent dynamic response without the hysteresis that is present in iron core based designs.

With a **bandwidth up to 2 MHz** and a temperature range of -40°C to $+105^{\circ}\text{C}$ the CMS3000 enables new application fields for highly-dynamic and compact current measurement.

The CMS3000 product family offers PCB-mountable THT current sensors in the range of 5 A up to 100 A nominal current for industrial applications.



CMS3005

Product overview CMS3005

Product description	Package	Delivery Type
CMS3005ABA	THT	Tray

Quick reference guide

Symbol	Parameter	Min.	Typ.	Max.	Unit
V_{CC}	Supply voltage	± 12	± 15	-	V
I_{PN}	Primary nominal current (RMS)	-	-	5	A
I_{PR}	Primary measuring range ¹⁾	-20	-	+20	A
f_{CO}	Frequency bandwidth (-3dB)	2	-	-	MHz
ϵ_{Σ}	Accuracy ²⁾	-	± 0.6	± 0.8	% of I_{PN}

¹⁾ For 3 s in a 60 s interval ($RMS \leq I_{PN}$) and $V_{CC} = \pm 15\text{ V}$.

²⁾ $\epsilon_{\Sigma} = \epsilon_G$ & ϵ_{lin} with $V_{CC} = \pm 15\text{ V}$, $I_P = I_{PN}$, $T_{amb} = 25^{\circ}\text{C}$

Qualification overview

Standard	Name	Status
2002/95/EC	RoHS-conformity	Approved
EN 61800-5-1: 2007	Adjustable speed electrical power drive systems	Approved
DIN EN 50178	Electronic equipment for use in power installations	Approved
UL508 (E251279)	Industrial control equipment	Pending

Features

- Based on the Anisotropic MagnetoResistive (AMR) effect
- Measuring range up to 4 times nominal current
- Galvanic isolation between primary and measurement circuit
- Pin-compatible with CMS2000 current sensor family
- Bipolar 15 V power supply

Advantages

- Very high bandwidth > 2 MHz
- Highly dynamic step response
- High signal-to-noise ratio
- Large temperature range -40°C to $+105^{\circ}\text{C}$
- Excellent accuracy
- Negligible hysteresis

Applications

- Electrical motor control
- DC/DC converter
- Laser diode driver
- Audio amplifier
- Condition Monitoring
- Switched mode power supplies
- Sensorless BLDC motors
- Induction heating converters
- Inductive charging



REG.-Nr.E150

CMS3005

Highly Dynamic MagnetoResistive Current Sensor ($I_{PN} = 5\text{ A}$)

Absolute maximum ratings

In accordance with the absolute maximum rating system (IEC60134).

Symbol	Parameter	Min.	Max.	Unit
V_+	Positive supply voltage	-0.3	17	V
V_-	Negative supply voltage	-17	0.3	V
I_{PM}	Maximum primary current ¹⁾	-50	+50	A
T_{amb}	Ambient temperature	-40	+105	°C
T_{stg}	Storage temperature	-40	+105	°C
T_B	Busbar temperature	-40	+105	°C

¹⁾ For 20 ms in a 20 s interval ($RMS \leq I_{PN}$).

Stresses beyond those listed under "Absolute Maximum Ratings" may cause permanent damage to the device. This is a stress rating only and functional operation of the device at these or any other conditions beyond those indicated in the operational sections of this specification is not implied. Exposure to absolute maximum rating conditions for extended periods may affect device reliability.

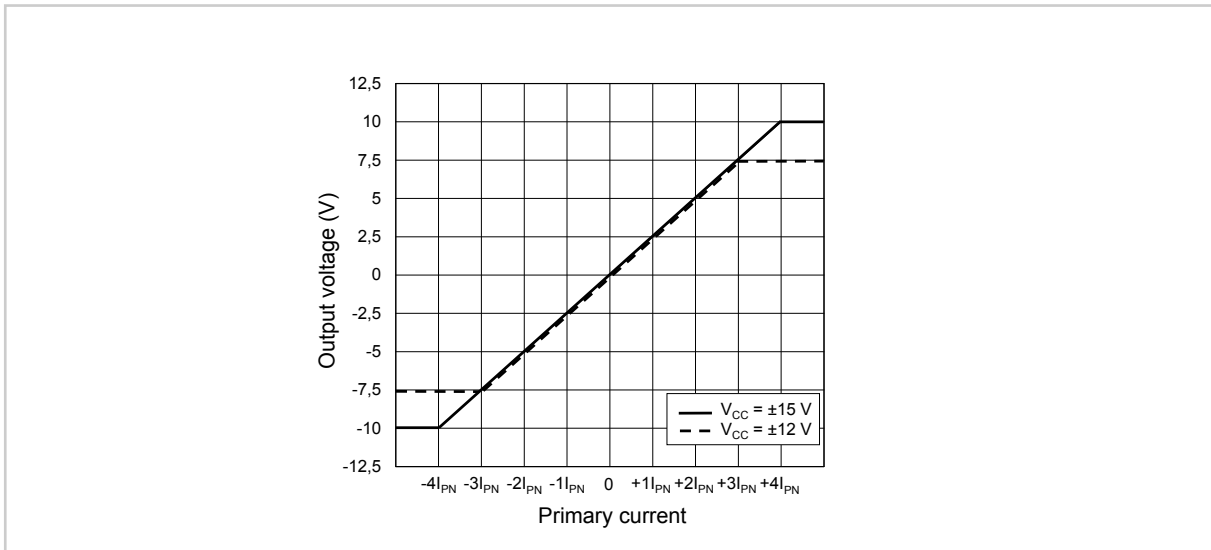

Fig. 1: Output voltage range for different supply voltages

CMS3005

Highly Dynamic MagnetoResistive Current Sensor ($I_{PN} = 5\text{ A}$)

Electrical data

$T_{amb} = 25\text{ °C}$; $V_{CC} = \pm 15\text{ V}$; unless otherwise specified.

Symbol	Parameter	Conditions	Min.	Typ.	Max.	Unit
V_+	Positive supply voltage		+14.3	+15.0	+15.7	V
V_-	Negative supply voltage		-14.3	-15.0	-15.7	V
I_{PN}	Primary nominal current (RMS)		-	-	5	A
I_{PR}	Measuring range ¹⁾		-20	-	+20	A
V_{outN}	Nominal output voltage (RMS)	$I_P = I_{PN}$, comp. Fig.1	-	2.5	-	V
R_M	Internal burden resistor for output signal		80	128	150	Ω
R_P	Resistance of primary conductor		-	9.5	12	m Ω
I_Q	Quiescent current	$I_P = 0$	-	21	25	mA
I_{CN}	Nominal current consumption	$I_P = I_{PN}$	-	40	50	mA
I_{CR}	Measuring range current consumption	$I_P = I_{PR}$	-	105	110	mA
I_{CM}	Maximal current consumption ²⁾	$I_P > I_{PR}$	-	-	130	mA

$T_{amb} = 25\text{ °C}$; $V_{CC} = \pm 12\text{ V}$; unless otherwise specified.

Symbol	Parameter	Conditions	Min.	Typ.	Max.	Unit
V_+	Positive supply voltage		+11.4	+12.0	+12.6	V
V_-	Negative supply voltage		-11.4	-12.0	-12.6	V
I_{PN}	Primary nominal current (RMS)		-	-	5	A
I_{PR}	Measuring range ¹⁾		-15	-	+15	A
V_{outN}	Nominal output voltage (RMS)	$I_P = I_{PN}$, comp. Fig.1	-	2.5	-	V
R_M	Internal burden resistor for output signal		80	128	150	Ω
R_P	Resistance of primary conductor		-	9.5	12	m Ω
I_Q	Quiescent current	$I_P = 0$	-	21	25	mA
I_{CN}	Nominal current consumption	$I_P = I_{PN}$	-	40	50	mA
I_{CR}	Measuring range current consumption	$I_P = I_{PR}$	-	80	95	mA
I_{CM}	Maximum current consumption ²⁾	$I_P > I_{PR}$	-	-	100	mA

Notes:

- ¹⁾ For 3 s in a 60 s interval ($RMS \leq I_{PN}$).
²⁾ Limited by output driver

CMS3005

Highly Dynamic MagnetoResistive Current Sensor ($I_{PN} = 5\text{ A}$)

Accuracy

$T_{amb} = 25\text{ °C}$; $V_{CC} = \pm 15\text{ V}$; unless otherwise specified.

Symbol	Parameter	Conditions	Min.	Typ.	Max.	Unit
ϵ_{Σ}	Accuracy ^{1) 2)}	$I_P \leq I_{PN}$	-	± 0.6	± 0.8	% of I_{PN}
ϵ_G	Gain error ²⁾	$I_P \leq I_{PN}$	-	± 0.5	± 0.7	% of I_{PN}
ϵ_{off}	Offset error ³⁾	$I_P = 0$	-	± 0.3	± 0.8	% of I_{PN}
ϵ_{Lin}	Linearity error	$I_P \leq I_{PN}$; symmetrical current feed	-	± 0.1	± 0.15	% of I_{PN}
ϵ_{Hys}	Hysteresis	$4 \cdot I_{PN}$, $\Delta t = 20\text{ ms}$	-	-	0.02	% of I_{PN}
PSRR	Power supply rejection rate	$f_{\Delta V_{CC}} \leq 5\text{ kHz}$	-	-63	-	dB
PSRR	Power supply rejection rate	$f_{\Delta V_{CC}} \leq 15\text{ kHz}$	-	-55	-45	dB
N_{RMS}	Noise level (RMS)	$f \leq 80\text{ kHz}$	-	0.25	0.3	mV
N_{pk}	Noise level (peak)	$f \leq 80\text{ kHz}$	-	2.2	3.0	mV

$T_{amb} = (-40 \dots +105)\text{ °C}$; $V_{CC} = \pm 15\text{ V}$; unless otherwise specified.

Symbol	Parameter	Conditions	Min.	Typ.	Max.	Unit
$T\epsilon_G$	Additional temperature induced gain error		-	-	± 1.0	% of I_{PN}
$T\epsilon_{G'}$	Additional temperature induced gain error	$T_{amb} = (-25 \dots +85)\text{ °C}$	-	-	± 0.7	% of I_{PN}
$T\epsilon_{off}$	Additional temperature induced offset error		-	-	± 2.0	% of I_{PN}
$T\epsilon_{off}$	Additional temperature induced offset error	$T_{amb} = (-25 \dots +105)\text{ °C}$	-	-	± 1.5	% of I_{PN}
$T\epsilon_{Lin}$	Additional temperature induced linearity error		-	-	± 0.1	% of I_{PN}
$T\epsilon_{\Sigma}$	Typical total accuracy ⁴⁾	$I_P \leq I_{PN}$	-	± 1.5	-	% of I_{PN}

Notes:

- ¹⁾ Accuracy contains ϵ_G and ϵ_{Lin} .
- ²⁾ Does not include additional error of 1.5% (I_{PN}) due to aging.
- ³⁾ Does not include additional error of 0.5% (I_{PN}) due to aging.
- ⁴⁾ Typical total accuracy measured in temperature range (including error at $T_{amb} = 25\text{ °C}$).

CMS3005

Highly Dynamic MagnetoResistive Current Sensor ($I_{PN} = 5\text{ A}$)

General data

Symbol	Parameter	Conditions	Min.	Typ.	Max.	Unit
T_{amb}	Ambient temperature ¹⁾		-40	-	+105	°C
T_{stg}	Storage temperature		-40	-	+105	°C
T_B	Busbar temperature ¹⁾		-40	-	+105	°C
T_{THT}	Solder temperature ²⁾	For 7 seconds.	-	-	265	°C
m	Mass		-	4.3	4.5	g

Dynamic data

$T_{amb} = 25\text{ °C}$; $V_{CC} = \pm 15\text{ V}$; unless otherwise specified.

Symbol	Parameter	Conditions	Min.	Typ.	Max.	Unit
t_{reac}	Reaction time ³⁾	10 % I_{PN} to 10 % $I_{out,N}$	-	0.02	0.05 ⁴⁾	μs
t_{rise}	Rise time ³⁾	10 % $I_{out,N}$ to 90 % $I_{out,N}$	-	0.04	0.08 ⁴⁾	μs
t_{resp}	Response time ³⁾	90 % I_{PN} to 90 % $I_{out,N}$	-	-	0.04 ⁴⁾	μs
f_{co}	Upper cut-off frequency	-3 dB	2	-	-	MHz
ΔV_{TR}	Transient output voltage	0 V to 530 V (3.7 kV/ μs); see Fig. 3	-	0.075 ⁴⁾	0.22	V
t_{recTR}	Transient recovery time	0 V to 530 V (3.7 kV/ μs); see Fig. 3	-	0.75	1.5 ⁴⁾	μs

Isolation characteristics

Symbol	Parameter	Conditions	Min.	Typ.	Max.	Unit
V_I	Isolation test voltage (RMS)	50/60 Hz, 60 s	4.4	-	-	kV
V_{imp}	Impulse withstand voltage	1.2/50 μs	8	-	-	kV
d_{cp}	Creepage distance		6.2	-	-	mm
d_{cl}	Clearance distance ⁵⁾		6.2	-	-	mm
V_B	System voltage (RMS) ⁶⁾	Reinforced isolation PD2, CAT III	300	-	-	V
V_B'	System voltage (RMS) ⁶⁾	Basic isolation PD2, CAT III	600	-	-	V
ESD	Electro static test voltage	HBM, contact discharge method	-	8	-	kV

Notes:

- ¹⁾ Operating condition.
- ²⁾ Depending on the size of the primary conductor, variation of pre-heating parameters (temperature, duration) might be necessary in order to ensure sufficient soldering results
- ³⁾ $I_P = I_{PN}$, di/dt of 70 A/ μs
- ⁴⁾ With recommended RC output filter values according to page 8.
- ⁵⁾ If mounted on a PCB, the minimal clearance distance might be reduced according to the PCB layout (e.g. diameter of drilling holes and annular rings).
- ⁶⁾ According to DIN EN 50178, DIN EN 61800-5-1

CMS3005

Highly Dynamic MagnetoResistive Current Sensor ($I_{PN} = 5 \text{ A}$)

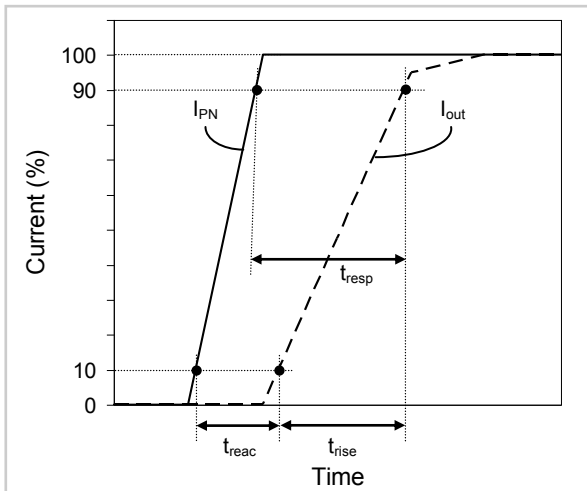

Fig. 2: Definition of reaction time (t_{reac}), rise time (t_{rise}) and response time (t_{resp}).

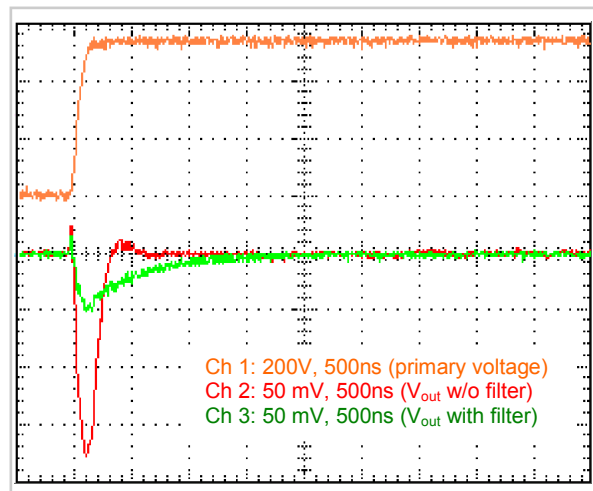

Fig. 3: dV/dt ($3.7\text{kV}/\mu\text{s}$; 530V voltage on primary conductor; filter configuration acc. to Tab. 1)

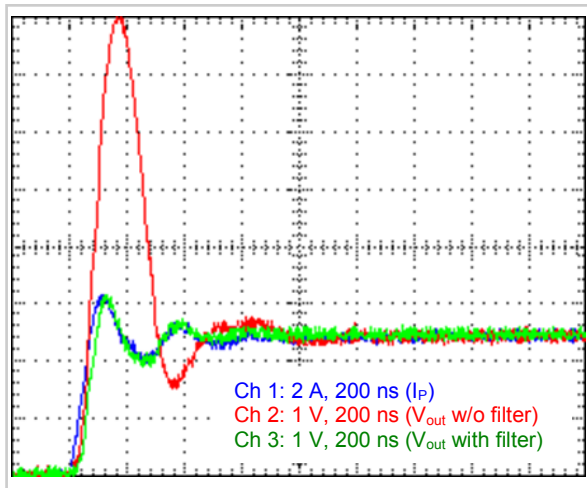

Fig. 4: Step response ($I_P = 5 \text{ A}$; $di/dt \approx 70 \text{ A}/\mu\text{s}$; filter configuration acc. to Tab. 1)

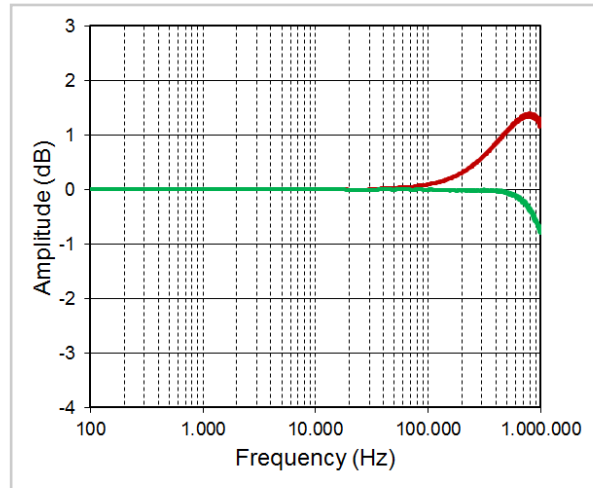

Fig. 5: Typical frequency response with RC-filter (green) and without (red). Filter configuration acc. to Tab. 1.

CMS3005

Highly Dynamic MagnetoResistive Current Sensor ($I_{PN} = 5\text{ A}$)

Pinning

Pin	Symbol	Parameter
1	V_+	Positive supply voltage
2	V_-	Negative supply voltage
3	GND	Ground
4	SGND	Signal ground
5	V_{out}	Signal output
6	I_{in}	Primary current input
7	I_{out}	Primary current output

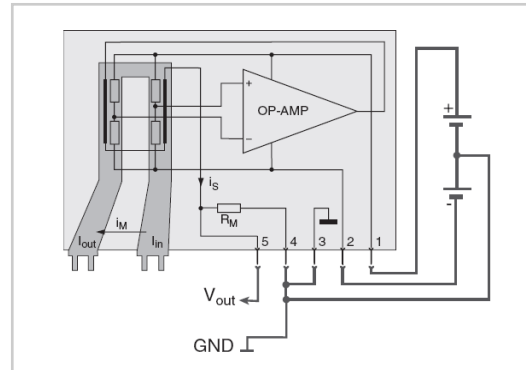

Fig. 6: Pinning of CMS3005.

Dimensions

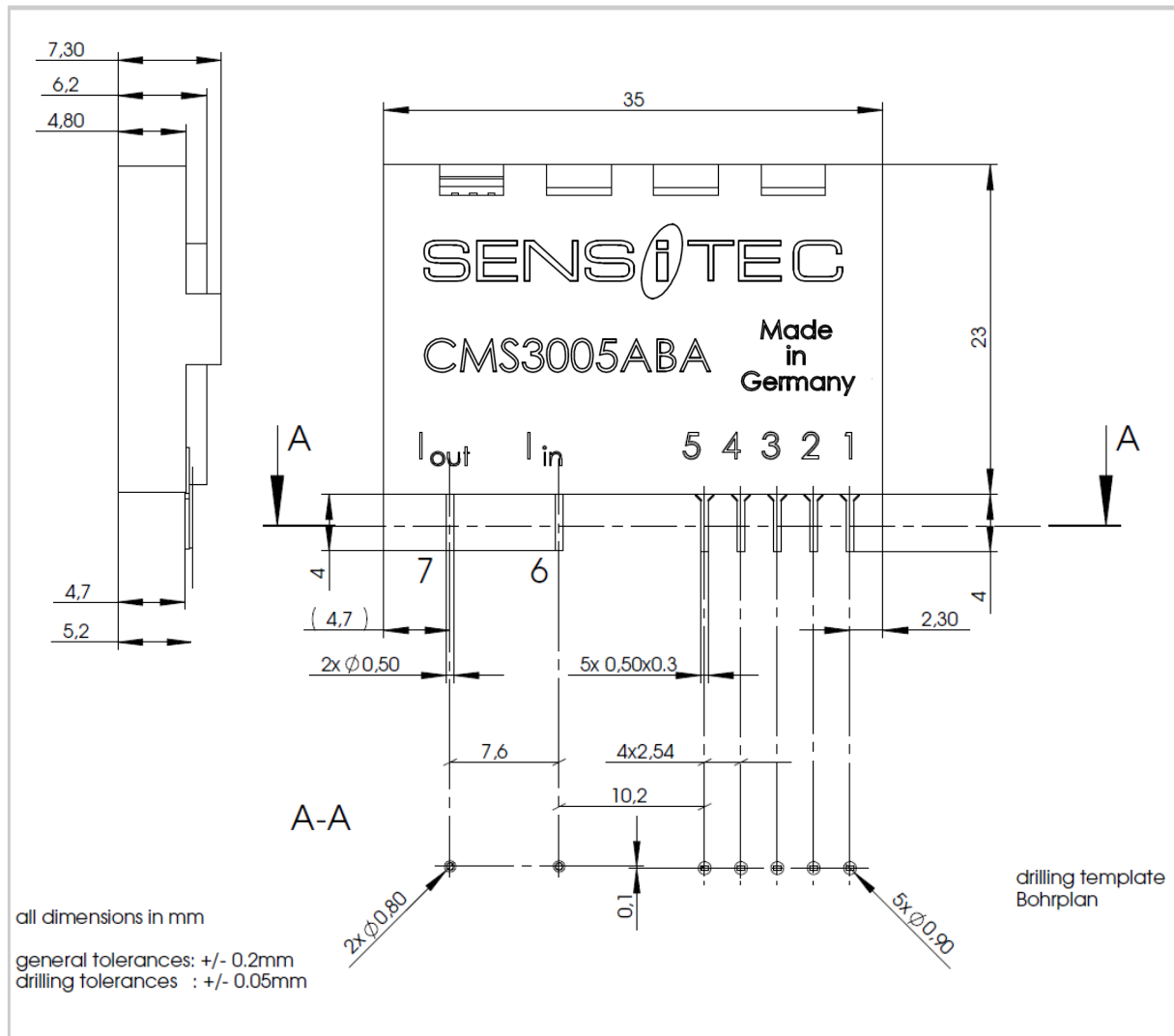

Fig.7: Package outline

CMS3005

Highly Dynamic MagnetoResistive Current Sensor ($I_{PN} = 5\text{ A}$)

Application circuit

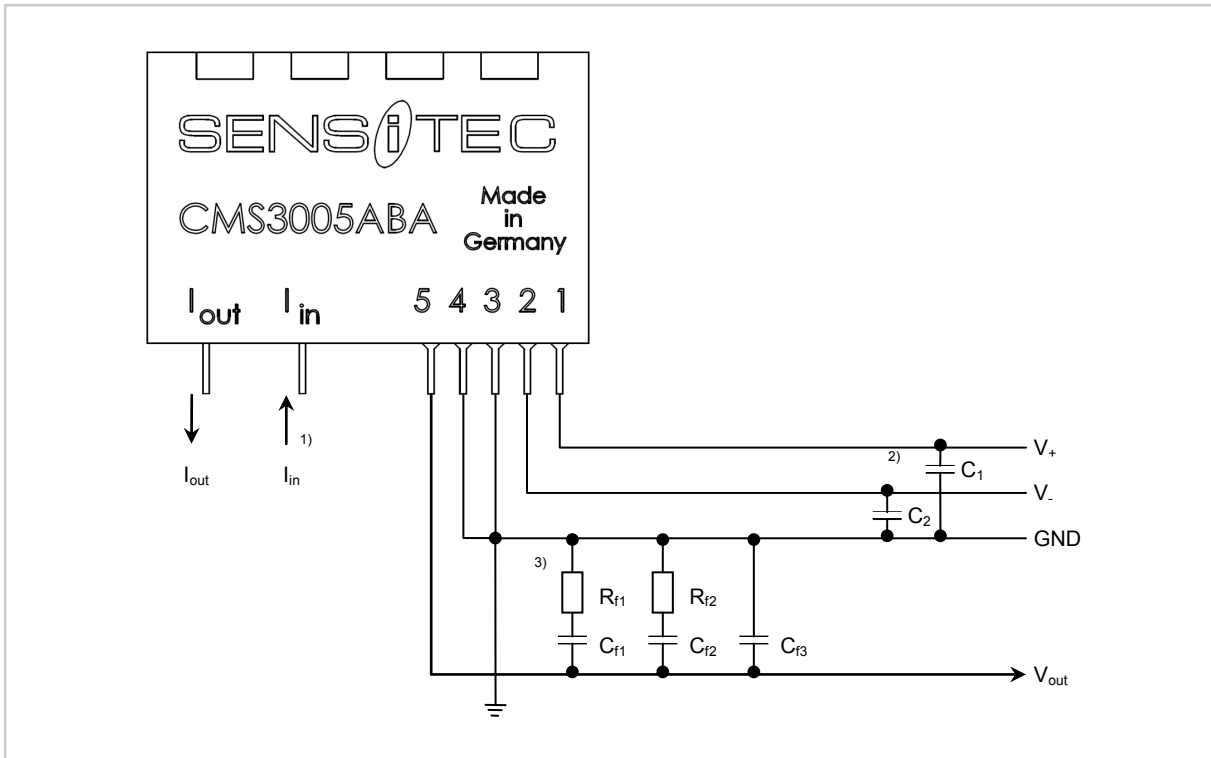

Fig. 8: Typical circuit to improve frequency response using a RC-filter network.

Filter configuration

Recommended RC-filter values for $di/dt \approx 70\text{ A}/\mu\text{s}$:

Type	R_{f1}	C_{f1}	R_{f2}	C_{f2}	C_{f3}
CMS3005ABA	15 Ω	3.3 nF	-	-	-

Notes

- 1) V_{out} is positive, if I_P flows from pin "I_{in}" to pin "I_{out}".
- 2) The power supply should always be buffered by 47 μF electrolytic capacitor C_1 and C_2 .
- 3) To improve the frequency response, an RC-filter is recommended according to Tab.1. Depending on the application, further optimization is possible.

CMS3005

Highly Dynamic MagnetoResistive Current Sensor ($I_{PN} = 5 \text{ A}$)

PCB Layout

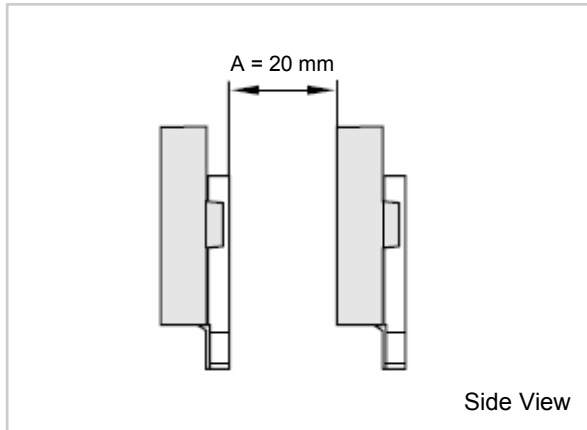

Fig. 9: Recommended clearance A among each other.

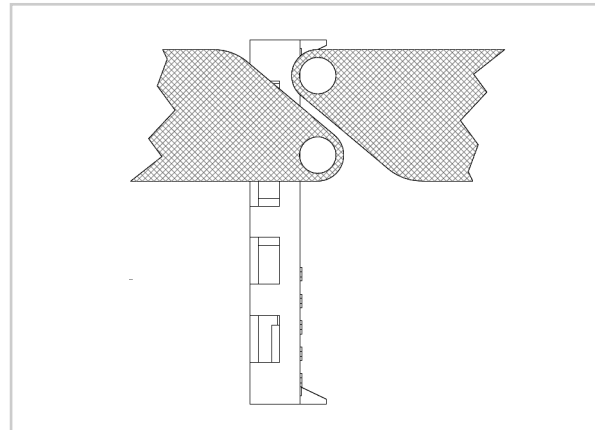

Fig. 10: Recommended current feed layout.

Additional notes for the designer

To operate the sensor within the specified accuracy, the following recommendations should be taken into account:

- In order to limit self-heating of the sensor and hence to not exceed the maximal allowed busbar temperature of 105°C , it is recommended to maximise the area of the current feeds on the PCB to provide a heat sink for the busbar. The required clearance and creepage distances need to be observed.
- The minimum clearance to other sources of magnetic fields (e.g. relays, motors, current conductors or permanent magnets) depends on the strength of the magnetic field. In order to keep the influence of magnetic stray fields on the current sensor signal below 1% (of I_{PN}), both homogeneous magnetic fields and magnetic field gradients at the position of the sensor chip (located at the centre of the primary conductor) should be below 1 kA/m and 15 (A/m)/mm ($18.7 \text{ } \mu\text{T/mm}$), respectively. Generally, shielding is possible to avoid influence of magnetic stray fields.

Example: A conductor carrying 1 A generates a magnetic field of 20 A/m and a magnetic field gradient of 2.5 (A/m)/mm at a distance of 8 mm .

- For multiple sensor arrangements, it is recommended to place the sensors including their current feeds with a clearance (A) of at least 20mm to each other as shown in Fig. 9. A smaller distance may cause cross talk to adjacent sensors. The primary current feeds in the PCB may not to be routed underneath a sensor.
- Parts made of electrically conductive material (e.g. housing parts made of aluminium) placed in close proximity to the sensor may affect the dynamic sensor behaviour due to the induced eddy currents in these parts.
- Parts made of ferromagnetic material (e.g. housing parts made of steel) placed in close proximity to the sensor may affect the sensor's accuracy as the magnetic field generated by the sensor's primary conductor may be disturbed.

CMS3005

Highly Dynamic MagnetoResistive Current Sensor ($I_{PN} = 5\text{ A}$)

The CMS3000 product family

The CMS3005 is a member of the CMS3000 product family offering PCB-mountable THT current sensors from 5 A up to 100 A nominal current with a typical bandwidth of 2 MHz for various industrial applications.

	CMS3005ABA	CMS3015ABA	CMS3025ABA	CMS3050ABA	CMS3100ABA
$I_{PN}^{1)}$	5 A	15 A	25 A	50 A	100 A
$I_{PR}^{2)}$	20 A	60 A	100 A	200 A	400 A

- The CMK3000 demoboard offers the opportunity to learn the features and benefits of the CMS3000 current sensors in a quick and simple manner.

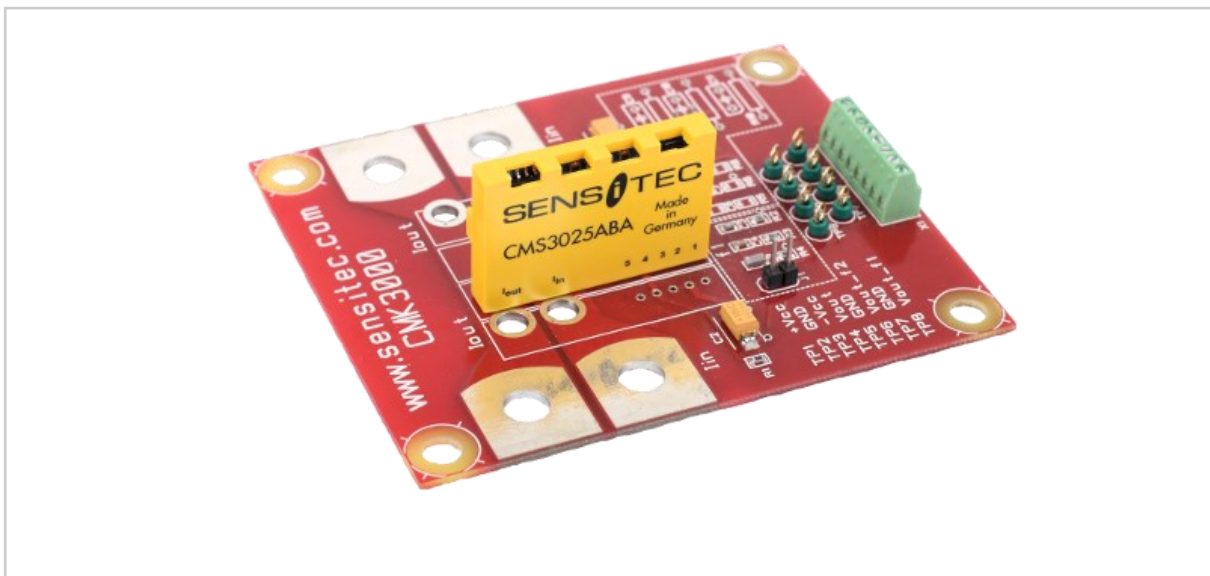

Fig. 11: The CMK3000 demoboards are available for different current ranges



Notes:

- ¹⁾ Nominal primary current (RMS)
- ²⁾ Measurement range

CMS3005

Highly Dynamic MagnetoResistive Current Sensor ($I_{PN} = 5\text{ A}$)

Safety Notes

	<p>Warning! This sensor shall be used in electric and electronic devices according to applicable standards and safety requirements. Sensitec's datasheet and handling instructions must be complied with. Handling instructions for current sensors are available at www.sensitec.com.</p>
	<p>Caution! Risk of electric shock! When operating the sensor, certain parts, e. g. the primary busbar or the power supply, may carry hazardous voltage. Ignoring this warning may lead to serious injuries! Conducting parts of the sensor shall not be accessible after installation.</p>

General information

Product status

Article	Status
CMS3005	The product is in series production.
Note	The status of the product may have changed since this data sheet was published. The latest information is available on the internet at www.sensitec.com .

Disclaimer

Sensitec GmbH reserves the right to make changes, without notice, in the products, including software, described or contained herein in order to improve design and/or performance. Information in this document is believed to be accurate and reliable. However, Sensitec GmbH does not give any representations or warranties, expressed or implied, as to the accuracy or completeness of such information and shall have no liability for the consequences of use of such information. Sensitec GmbH takes no responsibility for the content in this document if provided by an information source outside of Sensitec products.

In no event shall Sensitec GmbH be liable for any indirect, incidental, punitive, special or consequential damages (including but not limited to lost profits, lost savings, business interruption, costs related to the removal or replacement of any products or rework charges) irrespective the legal base the claims are based on, including but not limited to tort (including negligence), warranty, breach of contract, equity or any other legal theory.

Notwithstanding any damages that customer might incur for any reason whatsoever, Sensitec product aggregate and cumulative liability towards customer for the products described herein shall be limited in accordance with the General Terms and Conditions of Sale of Sensitec GmbH.

Nothing in this document may be interpreted or construed as an offer to sell products that is open for acceptance or the grant, conveyance or implication of any license under any copyrights, patents or other industrial or intellectual property rights.

Unless otherwise agreed upon in an individual agreement Sensitec products sold are subject to the General Terms and Conditions of Sales as published at www.sensitec.com.

CMS3005**Highly Dynamic MagnetoResistive Current Sensor ($I_{PN} = 5 \text{ A}$)**

Application information

Applications that are described herein for any of these products are for illustrative purposes only. Sensitec GmbH makes no representation or warranty – whether expressed or implied – that such applications will be suitable for the specified use without further testing or modification.

Customers are responsible for the design and operation of their applications and products using Sensitec products, and Sensitec GmbH accepts no liability for any assistance with applications or customer product design. It is customer's sole responsibility to determine whether the Sensitec product is suitable and fit for the customer's applications and products planned, as well as for the planned application and use of customer's third party customer(s). Customers should provide appropriate design and operating safeguards to minimize the risks associated with their applications and products.

Sensitec GmbH does not accept any liability related to any default, damage, costs or problem which is based on any weakness or default in the customer's applications or products, or the application or use by customer's third party customer(s). Customer is responsible for doing all necessary testing for the customer's applications and products using Sensitec products in order to avoid a default of the applications and the products or of the application or use by customer's third party customer(s). Sensitec does not accept any liability in this respect.

Life critical applications

These products are not qualified for use in life support appliances, aeronautical applications or devices or systems where malfunction of these products can reasonably be expected to result in personal injury.

SENSITEC

MagnetoResistive Sensors

Sensitec GmbH
Georg-Ohm-Straße 11
35633 Lahnau
Germany
Fon +49 (0) 6441 9788-0
Fax +49 (0) 6441 9788-17
E-Mail info@sensitec.com
www.sensitec.com

Solutions for measuring:

- Position
- Angle
- Magnetic field
- Current

Copyright © 2013 by Sensitec GmbH, Germany

All rights reserved. No part of this document may be copied or reproduced in any form or by any means without the prior written agreement of the copyright owner. The information in this document is subject to change without notice. Please observe that typical values cannot be guaranteed.

Sensitec GmbH does not assume any liability for any consequence of its use.