

Optocoupler, Phototransistor Output, High Reliability, 5300 V_{RMS}

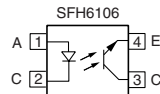
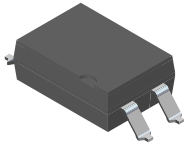
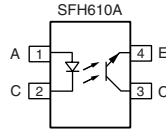
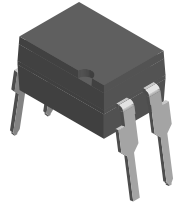

1179056

DESCRIPTION

The SFH610A (DIP) and SFH6106 (SMD) feature a high current transfer ratio, low coupling capacitance and high isolation voltage. These couplers have a GaAs infrared diode emitter, which is optically coupled to a silicon planar phototransistor detector, and is incorporated in a plastic DIP-4 or SMD package.

The coupling devices are designed for signal transmission between two electrically separated circuits.

The couplers are end-stackable with 2.54 mm spacing. Creepage and clearance distances of > 8.0 mm are achieved with option 6. This version complies with IEC 60950 (DIN VDE 0805) for reinforced insulation up to an operation voltage of 400 V_{RMS} or DC. Specifications subject to change.

FEATURES

- Good CTR linearity depending on forward current
- Isolation test voltage, 5300 V_{RMS}
- High collector emitter voltage, V_{CEO} = 70 V
- Low saturation voltage
- Fast switching times
- Low CTR degradation
- Temperature stable
- Low coupling capacitance
- End stackable, 0.100" (2.54 mm) spacing
- High common mode interference immunity
- Lead (Pb)-free component
- Component in accordance to RoHS 2002/95/EC and WEEE 2002/96/EC

RoHS
COMPLIANT

AGENCY APPROVALS

- UL1577, file no. E52744 system code H or J, double protection
- DIN EN 60747-5-5 (VDE 0884) available with option 1
- CSA 93751
- BSI IEC 60950; IEC 60065

ORDER INFORMATION

PART	REMARKS
SFH610A-1	CTR 40 % to 80 %, DIP-4
SFH610A-2	CTR 63 % to 125 %, DIP-4
SFH610A-3	CTR 100 % to 200 %, DIP-4
SFH610A-4	CTR 160 % to 320 %, DIP-4
SFH610A-5	CTR 250 % to 500 %, DIP-4
SFH6106-1	CTR 40 % to 80 %, SMD-4
SFH6106-2	CTR 63 % to 125 %, SMD-4
SFH6106-3	CTR 100 % to 200 %, SMD-4
SFH6106-4	CTR 160 % to 320 %, SMD-4
SFH6106-5T	CTR 250 % to 500 %, SMD-4, tape and reel
SFH610A-1X006	CTR 40 % to 80 %, DIP-4 400 mil
SFH610A-1X018T	CTR 40 % to 80 %, SMD-4 400 mil, wide leadspread
SFH610A-2X006	CTR 63 % to 125 %, DIP-4 400 mil
SFH610A-3X006	CTR 100 % to 200 %, DIP-4 400 mil
SFH610A-3X007	CTR 100 % to 200 %, SMD-4
SFH610A-4X006	CTR 160 % to 320 %, DIP-4 400 mil

Note

For additional information on the available options refer to option information.

ABSOLUTE MAXIMUM RATINGS (1)				
PARAMETER	TEST CONDITION	SYMBOL	VALUE	UNIT
INPUT				
Reverse voltage		V _R	6	V
DC forward current		I _F	60	mA
Surge forward current	t ≤ 10 μs	I _{FSM}	2.5	A
Power dissipation		P _{diss}	100	mW
OUTPUT				
Collector emitter voltage		V _{CE}	70	V
Emitter collector voltage		V _{EC}	7	V
Collector current	t _p ≤ 1.0 ms	I _C	50	mA
		I _C	100	mA
Power dissipation		P _{diss}	150	mW
COUPLER				
Isolation test voltage between emitter and detector		V _{ISO}	5300	V _{RMS}
Creepage distance			≥ 7	mm
Clearance distance			≥ 7	mm
Insulation thickness between emitter and detector			≥ 0.4	mm
Comparative tracking index per DIN IEC112/VDE 0303 part 1			≥ 175	
Isolation resistance	V _{IO} = 500 V, T _{amb} = 25 °C	R _{IO}	≥ 10 ¹²	Ω
	V _{IO} = 500 V, T _{amb} = 100 °C	R _{IO}	≥ 10 ¹¹	Ω
Storage temperature range		T _{stg}	- 55 to + 150	°C
Ambient temperature range		T _{amb}	- 55 to + 100	°C
Soldering temperature (2)	max. 10 s, dip soldering distance to seating plane ≥ 1.5 mm	T _{slid}	260	°C

Notes

(1) T_{amb} = 25 °C, unless otherwise specified.

Stresses in excess of the absolute maximum ratings can cause permanent damage to the device. Functional operation of the device is not implied at these or any other conditions in excess of those given in the operational sections of this document. Exposure to absolute maximum ratings for extended periods of the time can adversely affect reliability.

(2) Refer to reflow profile for soldering conditions for surface mounted devices (SMD). Refer to wave profile for soldering conditions for through hole devices (DIP).

ELECTRICAL CHARACTERISTICS							
PARAMETER	TEST CONDITION	PART	SYMBOL	MIN.	TYP.	MAX.	UNIT
INPUT							
Forward voltage	I _F = 60 mA		V _F		1.25	1.65	V
Reverse current	V _R = 6 V		I _R		0.01	10	μA
Capacitance	V _R = 0 V, f = 1 MHz		C _O		13		pF
Thermal resistance			R _{thja}		750		K/W
OUTPUT							
Collector emitter capacitance	V _{CE} = 5 V, f = 1 MHz		C _{CE}		5.2		pF
Thermal resistance			R _{thja}		500		K/W
Collector emitter leakage current	V _{CE} = 10 V	SFH610A-1	I _{CEO}		2	50	nA
		SFH6106-1	I _{CEO}		2	50	nA
		SFH610A-2	I _{CEO}		2	50	nA
		SFH6106-2	I _{CEO}		2	50	nA
		SFH610A-3	I _{CEO}		5	100	nA
		SFH6106-3	I _{CEO}		5	100	nA
		SFH610A-4	I _{CEO}		5	100	nA
		SFH6106-4	I _{CEO}		5	100	nA
		SFH610A-5	I _{CEO}		5	100	nA
SFH6106-5T	I _{CEO}		5	100	nA		



ELECTRICAL CHARACTERISTICS							
PARAMETER	TEST CONDITION	PART	SYMBOL	MIN.	TYP.	MAX.	UNIT
COUPLER							
Collector emitter saturation voltage	$I_F = 10 \text{ mA}, I_C = 2.5 \text{ mA}$		V_{CEsat}		0.25	0.4	V
Coupling capacitance	$f = 1 \text{ MHz}$		C_C		0.4		pF

Note

$T_{amb} = 25 \text{ }^\circ\text{C}$, unless otherwise specified.

Minimum and maximum values are testing requirements. Typical values are characteristics of the device and are the result of engineering evaluation. Typical values are for information only and are not part of the testing requirements.

CURRENT TRANSFER RATIO							
PARAMETER	TEST CONDITION	PART	SYMBOL	MIN.	TYP.	MAX.	UNIT
I_C/I_F	$I_F = 10 \text{ mA}, V_{CE} = 5.0 \text{ V}$	SFH610A-1	CTR	40		80	%
		SFH6106-1	CTR	40		80	%
		SFH610A-2	CTR	63		125	%
		SFH6106-2	CTR	63		125	%
		SFH610A-3	CTR	100		200	%
		SFH6106-3	CTR	100		200	%
		SFH610A-4	CTR	160		320	%
		SFH6106-4	CTR	160		320	%
	$I_F = 1 \text{ mA}, V_{CE} = 5 \text{ V}$	SFH610A-5	CTR	250		500	%
		SFH6106-5T	CTR	250		500	%
		SFH610A-1	CTR	13	30		%
		SFH6106-1	CTR	13	30		%
		SFH610A-2	CTR	22	45		%
		SFH6106-2	CTR	22	45		%
		SFH610A-3	CTR	34	70		%
		SFH6106-3	CTR	34	70		%
SFH610A-4	CTR	56	90		%		
SFH6106-4	CTR	56	90		%		

SWITCHING CHARACTERISTICS							
PARAMETER	TEST CONDITION	PART	SYMBOL	MIN.	TYP.	MAX.	UNIT
NON-SATURATED							
Current	$V_{CC} = 5 \text{ V}, R_L = 75 \text{ } \Omega$		I_F		10		mA
Rise time	$V_{CC} = 5 \text{ V}, R_L = 75 \text{ } \Omega$		t_r		2		μs
Fall time	$V_{CC} = 5 \text{ V}, R_L = 75 \text{ } \Omega$		t_f		2		μs
Turn-on time	$V_{CC} = 5 \text{ V}, R_L = 75 \text{ } \Omega$		t_{on}		3		μs
Turn-off time	$V_{CC} = 5 \text{ V}, R_L = 75 \text{ } \Omega$		t_{off}		2.3		μs
Cut-off frequency	$V_{CC} = 5 \text{ V}$		F_{CO}		250		kHz
SATURATED							
Current		SFH610A-1	I_F		20		mA
		SFH6106-1					
		SFH610A-2	I_F		10		mA
		SFH6106-2					
		SFH610A-3	I_F		10		mA
		SFH6106-3					
SFH610A-4	I_F		5		mA		
SFH6106-4							

SFH610A, SFH6106

Vishay Semiconductors

Optocoupler, Phototransistor Output,
High Reliability, 5300 V_{RMS}



SWITCHING CHARACTERISTICS							
PARAMETER	TEST CONDITION	PART	SYMBOL	MIN.	TYP.	MAX.	UNIT
SATURATED							
Rise time		SFH610A-1	t_r		2		μs
		SFH6106-1					
		SFH610A-2	t_r		3		
		SFH6106-2					
		SFH610A-3	t_r		3		
		SFH6106-3					
SFH610A-4	t_r	4					
SFH6106-4							
Fall time		SFH610A-1	t_f		11		μs
		SFH6106-1					
		SFH610A-2	t_f		14		
		SFH6106-2					
		SFH610A-3	t_f		14		
		SFH6106-3					
SFH610A-4	t_f	15					
SFH6106-4							
Turn-on time		SFH610A-1	t_{on}		3		μs
		SFH6106-1					
		SFH610A-2	t_{on}		4.2		
		SFH6106-2					
		SFH610A-3	t_{on}		4.2		
		SFH6106-3					
SFH610A-4	t_{on}	6					
SFH6106-4							
Turn-off time		SFH610A-1	t_{off}		18		μs
		SFH6106-1					
		SFH610A-2	t_{off}		23		
		SFH6106-2					
		SFH610A-3	t_{off}		23		
		SFH6106-3					
SFH610A-4	t_{off}	25					
SFH6106-4							

Note

All values presented are typical values.



SAFETY AND INSULATION RATINGS						
PARAMETER	TEST CONDITION	SYMBOL	MIN.	TYP.	MAX.	UNIT
Climatic classification (according to IEC 68 part 1)				55/100/21		
Comparative tracking index		CTI	175		399	
V _{IOTM}			10000			V
V _{IORM}			890			V
P _{SO}					400	mW
I _{SI}					275	mA
T _{SI}					175	°C
Creepage distance	standard DIP-4		7			mm
Clearance distance	standard DIP-4		7			mm
Creepage distance	400 mil DIP-4		8			mm
Clearance distance	400 mil DIP-4		8			mm
Insulation thickness, reinforced rated	per IEC 60950 2.10.5.1		0.4			mm

Note

As per IEC 60747-5-2, § 7.4.3.8.1, this optocoupler is suitable for "safe electrical insulation" only within the safety ratings. Compliance with the safety ratings shall be ensured by means of protective circuits.

TYPICAL CHARACTERISTICS

T_{amb} = 25 °C, unless otherwise specified

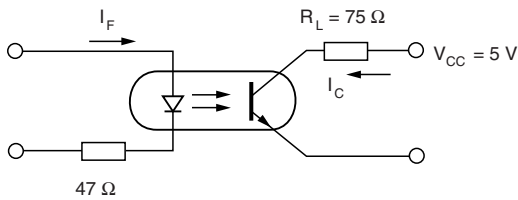

isfh610a_01

Fig. 1 - Linear Operation (without Saturation)

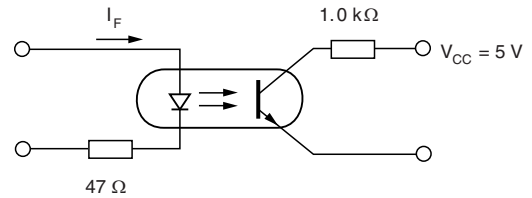

isfh610a_02

Fig. 3 - Switching Operation (with Saturation)

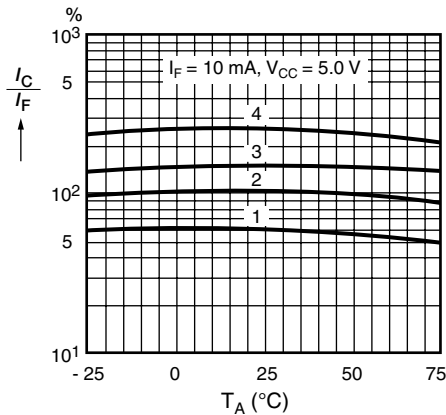

isfh610a_03

Fig. 2 - Current Transfer Ratio (CTR) vs. Temperature

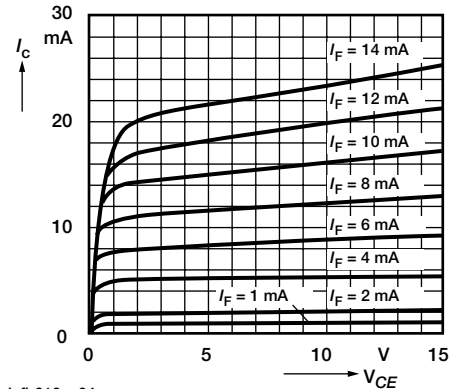

isfh610a_04

Fig. 4 - Output Characteristics (Typ.) Collector Current vs. Collector Emitter Voltage

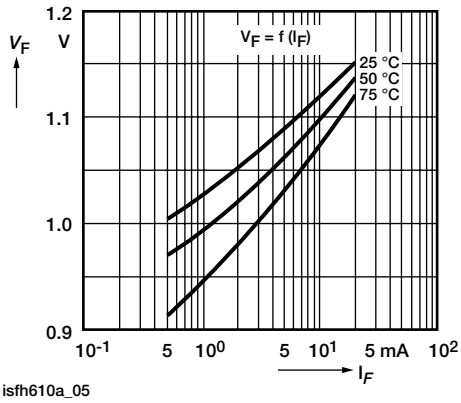

isfh610a_05

Fig. 5 - Diode Forward Voltage vs. Forward Current

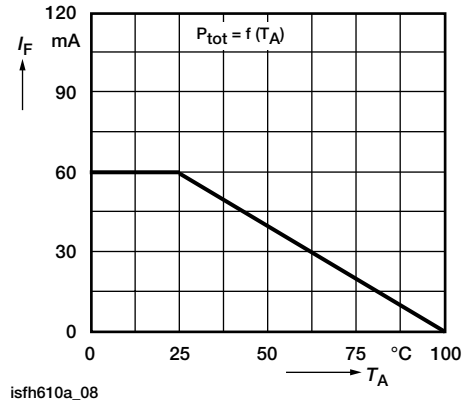

isfh610a_08

Fig. 8 - Permissible Power Dissipation vs. Temperature

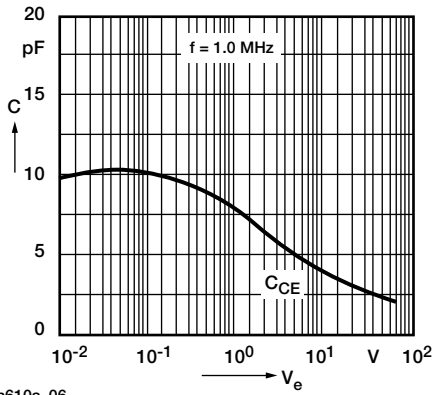

isfh610a_06

Fig. 6 - Transistor Capacitance (Typ.) vs. Collector Emitter Voltage

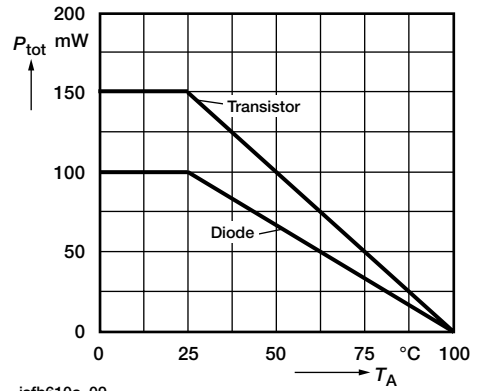

isfh610a_09

Fig. 9 - Permissible Diode Forward Current vs. Ambient Temperature

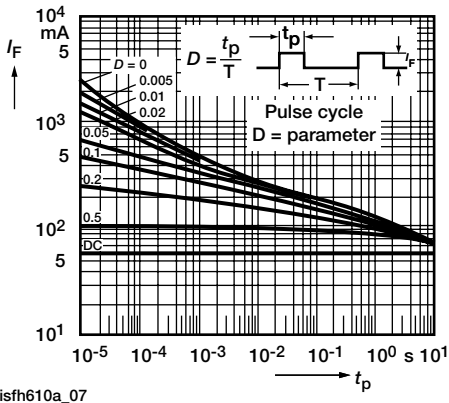

isfh610a_07

Fig. 7 - Permissible Pulse Handling Capability Forward Current vs. Pulse Width



SFH610A, SFH6106

Optocoupler, Phototransistor Output, Vishay Semiconductors
High Reliability, 5300 V_{RMS}

PACKAGE DIMENSIONS in inches (millimeters)

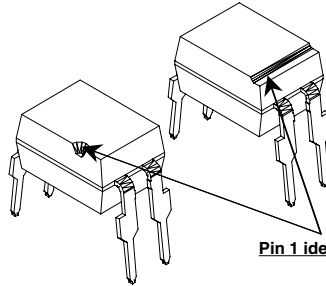
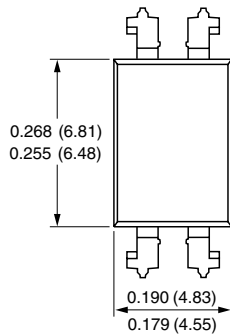

Pin 1 identification

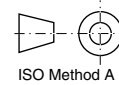
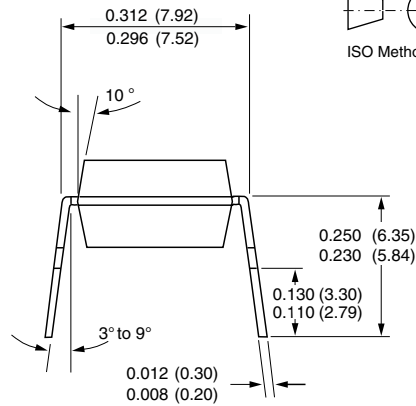
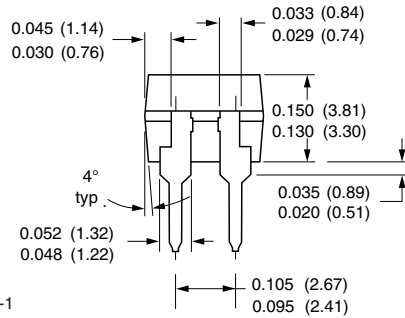

ISO Method A

i178027-1

SMD

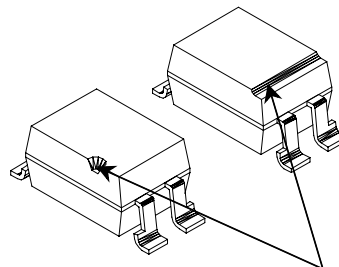
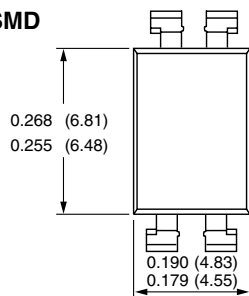

PIN 1 IDENTIFICATION

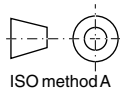
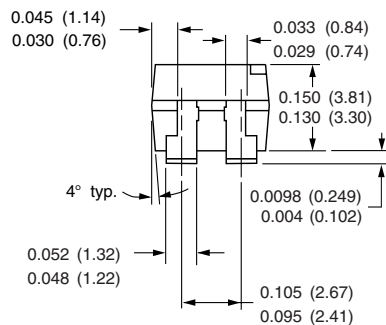
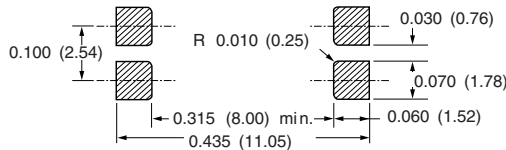

ISO method A

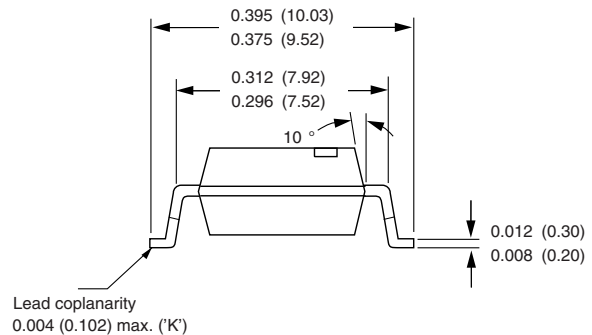

Lead coplanarity
0.004 (0.102) max. ('K')

i178029-2

SFH610A, SFH6106

Vishay Semiconductors

Optocoupler, Phototransistor Output,
High Reliability, 5300 V_{RMS}



Option 6

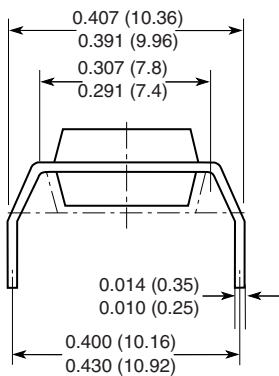

Option 7

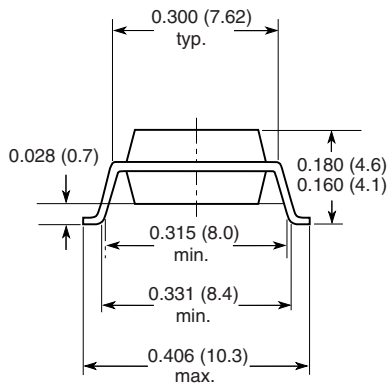

Option 8

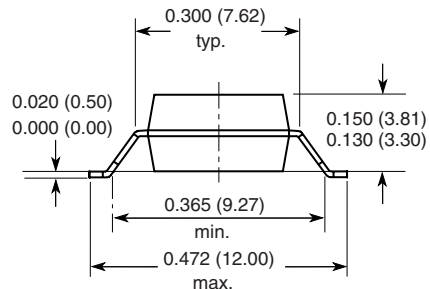

18487

**OZONE DEPLETING SUBSTANCES POLICY STATEMENT**

It is the policy of Vishay Semiconductor GmbH to

1. Meet all present and future national and international statutory requirements.
2. Regularly and continuously improve the performance of our products, processes, distribution and operating systems with respect to their impact on the health and safety of our employees and the public, as well as their impact on the environment.

It is particular concern to control or eliminate releases of those substances into the atmosphere which are known as ozone depleting substances (ODSs).

The Montreal Protocol (1987) and its London Amendments (1990) intend to severely restrict the use of ODSs and forbid their use within the next ten years. Various national and international initiatives are pressing for an earlier ban on these substances.

Vishay Semiconductor GmbH has been able to use its policy of continuous improvements to eliminate the use of ODSs listed in the following documents.

1. Annex A, B and list of transitional substances of the Montreal Protocol and the London Amendments respectively.
2. Class I and II ozone depleting substances in the Clean Air Act Amendments of 1990 by the Environmental Protection Agency (EPA) in the USA.
3. Council Decision 88/540/EEC and 91/690/EEC Annex A, B and C (transitional substances) respectively.

Vishay Semiconductor GmbH can certify that our semiconductors are not manufactured with ozone depleting substances and do not contain such substances.

We reserve the right to make changes to improve technical design
and may do so without further notice.

Parameters can vary in different applications. All operating parameters must be validated for each customer application by the customer. Should the buyer use Vishay Semiconductors products for any unintended or unauthorized application, the buyer shall indemnify Vishay Semiconductors against all claims, costs, damages, and expenses, arising out of, directly or indirectly, any claim of personal damage, injury or death associated with such unintended or unauthorized use.

Vishay Semiconductor GmbH, P.O.B. 3535, D-74025 Heilbronn, Germany



Disclaimer

All product specifications and data are subject to change without notice.

Vishay Intertechnology, Inc., its affiliates, agents, and employees, and all persons acting on its or their behalf (collectively, "Vishay"), disclaim any and all liability for any errors, inaccuracies or incompleteness contained herein or in any other disclosure relating to any product.

Vishay disclaims any and all liability arising out of the use or application of any product described herein or of any information provided herein to the maximum extent permitted by law. The product specifications do not expand or otherwise modify Vishay's terms and conditions of purchase, including but not limited to the warranty expressed therein, which apply to these products.

No license, express or implied, by estoppel or otherwise, to any intellectual property rights is granted by this document or by any conduct of Vishay.

The products shown herein are not designed for use in medical, life-saving, or life-sustaining applications unless otherwise expressly indicated. Customers using or selling Vishay products not expressly indicated for use in such applications do so entirely at their own risk and agree to fully indemnify Vishay for any damages arising or resulting from such use or sale. Please contact authorized Vishay personnel to obtain written terms and conditions regarding products designed for such applications.

Product names and markings noted herein may be trademarks of their respective owners.