

SEMIPACK® 2 Fast Diode¹⁾ Modules

SKKD 150 F
SKMD 150 F
SKND 150 F



V_{RSM} V_{RRM}	I_{FRMS} (maximum values for continuous operation) 220 A		
V	I_{FAV} (sin. 180; $T_{case} = 85\text{ °C}$; 50 Hz) 117 A		
1100	SKKD 150 F 11	SKMD 150 F 11	SKND 150 F 11
1200	SKKD 150 F 12	SKMD 150 F 12	SKND 150 F 12

Symbol	Conditions	SKKD 150 F SKMD 150 F SKND 150 F	Units	
I_{FAV}	sin. 180; $T_{case} = 65\text{ °C}$	140	A	
I_{FSM}	$T_{vj} = 25\text{ °C}$; 10 ms	2 000	A	
	$T_{vj} = 150\text{ °C}$; 10 ms	1 800	A	
i^2t	$T_{vj} = 25\text{ °C}$; 8,3 ... 10 ms	20 000	A^2s	
	$T_{vj} = 150\text{ °C}$; 8,3 ... 10 ms	16 200	A^2s	
I_{RM}	$T_{vj} = 25\text{ °C}$ $\left\{ \begin{array}{l} I_F = 150\text{ A} \\ di/dt = 500\text{ A}/\mu s \\ V_R = 600\text{ V} \end{array} \right.$	40	A	
		70	A	
t_{rr}	$T_{vj} = 25\text{ °C}$	typ. 180	ns	
Q_{rr}	$T_{vj} = 150\text{ °C}$	35	μC	
I_R	$T_{vj} = 25\text{ °C}$; $V_R = V_{RRM}$	1	mA	
	$T_{vj} = 150\text{ °C}$; $V_R = V_{RRM}$	40	mA	
V_F	$T_{vj} = 25\text{ °C}$; $I_F = 150\text{ A}$	2,2	V	
	$T_{vj} = 150\text{ °C}$; $I_F = 150\text{ A}$	2,0	V	
$V_{(TO)}$	$T_{vj} = 150\text{ °C}$	1,2	V	
r_T	$T_{vj} = 150\text{ °C}$	5,5	m Ω	
R_{thjc}	per diode / per module	0,2 / 0,1	$^{\circ}C/W$	
R_{thch}	per diode / per module	0,1 / 0,05	$^{\circ}C/W$	
T_{vj}		- 40 ... +150	$^{\circ}C$	
T_{stg}		- 40 ... +150	$^{\circ}C$	
V_{isol}	a. c. 50 Hz; r.m.s; 1 min	4000	V~	
M_1	to heatsink	SI units	5 \pm 15 %	Nm
		US units	44 \pm 15 %	lb. in
M_2	for terminals	SI units	5 \pm 15 %	Nm
		US units	44 \pm 15 %	lb. in
w	approx.	250	g	
Case	→ page B 2 – 28	SKKD 150 F SKMD 150 F SKND 150 F	A 53 A 51 A 52	

¹⁾ CAL (controlled axial lifetime) technology, patent No. DE 43 10 44

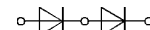

SKKD



SKMD

SKND

Features

- Soft recovery
- Very short recovery times
- Low switching losses
- Up to 1200 V peak inverse voltage
- Heat transfer through ceramic isolated metal baseplate
- **SKKD** half bridge connection
centre tap connections:
SKMD common cathode
SKND common anode
- UL recognized, file no. E63 532

Typical Applications

- Self-commutated inverters
- DC choppers
- AC motor speed control
- Inductive heating
- Uninterruptible power supplies
- Electronic welders
- General power switching applications

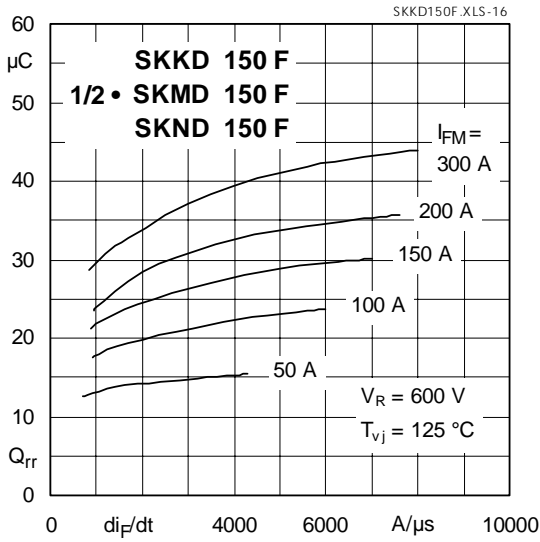

Fig. 16 Typ. recovered charge vs. current decrease

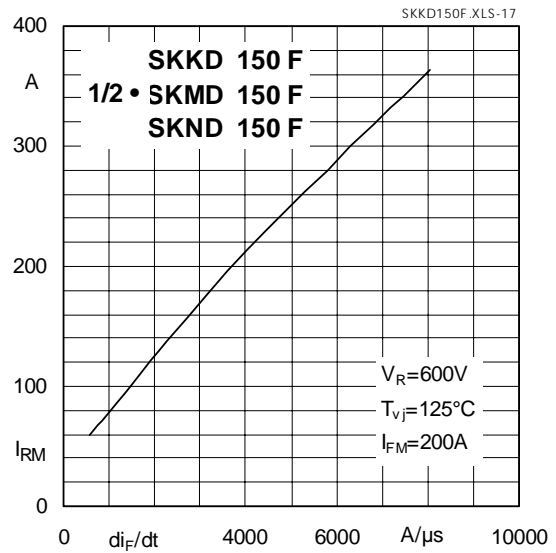

Fig. 17 Typ. peak recovery current vs. current decrease

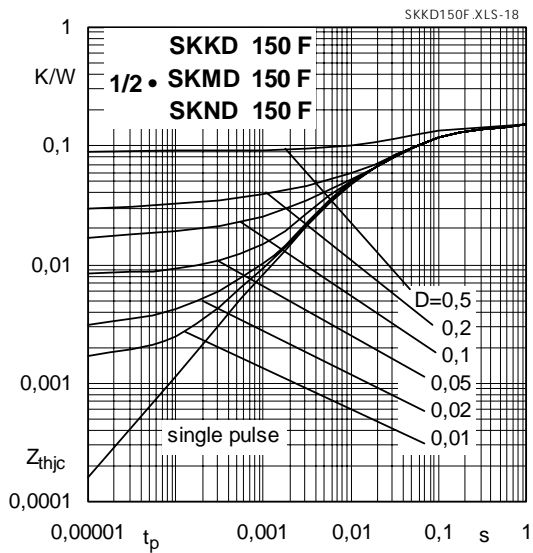

Fig. 18 Typ. transient thermal impedance vs. time

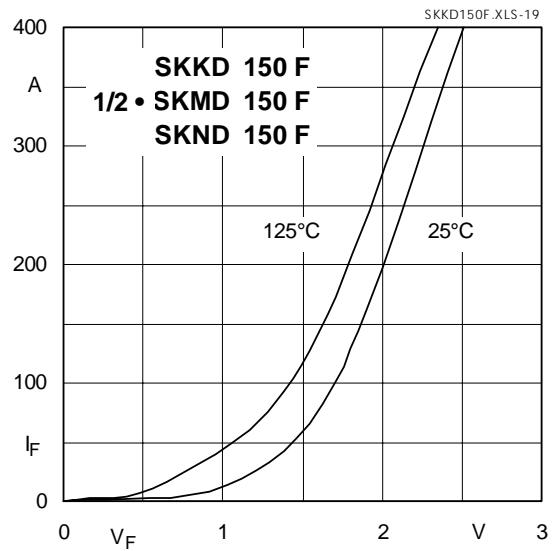

Fig. 19 Typ. forward characteristics

SKKD 105 F, 115 F

Case A 10

IEC 192-2: A 77 A
JEDEC: TO-240 AA

SEMIPACK® 1

UL recognized, file no. E 63 532

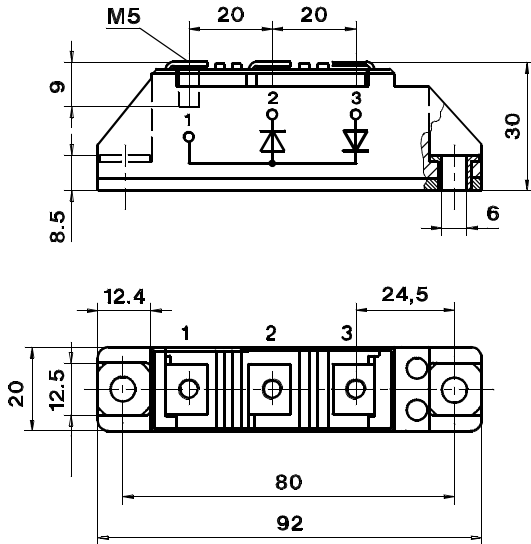
**SKKD 60 F, 75 F**

Case A 23

SEMIPACK® 2

UL recognized, file no. E 63 532

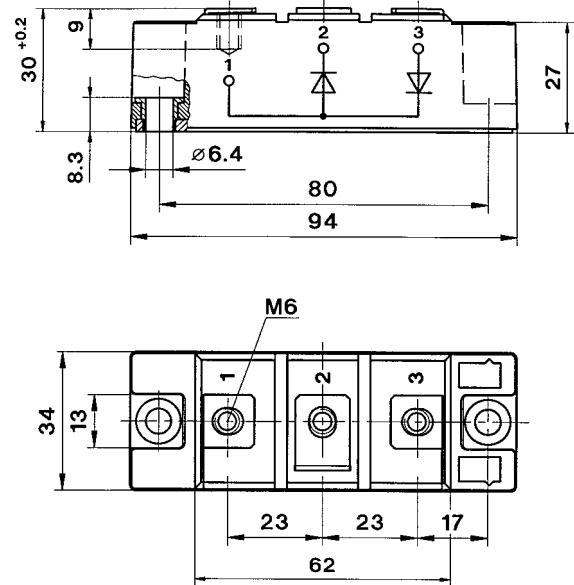
**SKMD 105 F**

Case A 33

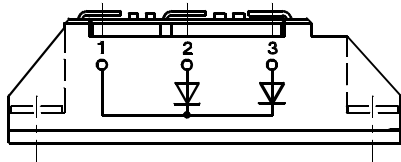
**SKMD 150 F, 202 E**

Case A 51

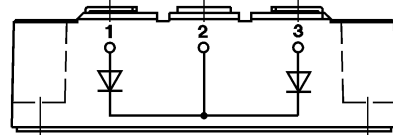
**SKND 105 F**

Case A 37

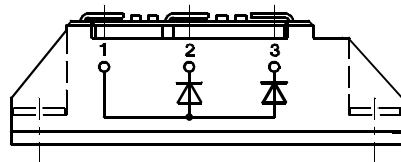

Dimensions in mm

SKND 150 F, 202 E

Case A 52

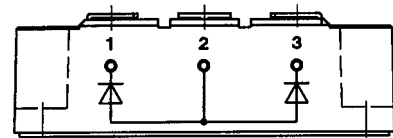
**SKKD 150 F, 170 F**

Case A 53

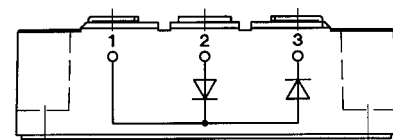

Dimensions in mm