

TDC1000-C2000EVM User's Guide

User's Guide



Literature Number: SNIU023
December 2014

1	EVM Key Features	4
	1.1 EVM	5
2	Equipment List	6
3	Quick Start	6
4	Software Installation.....	7
	4.1 Graphical User Interface (GUI)	7
	4.2 Installing the Driver	7
	4.3 Opening the GUI	8
5	Hardware Configuration	9
	5.1 EVM Connections	9
	5.2 Jumpers	9
	5.3 LEDs.....	10
6	GUI and operation	10
7	Board Layout	14
8	Schematic	19
9	Bill of Materials	22

List of Figures

1	TDC1000-C2000EVM Evaluation Board.....	5
2	Water Container with 1-MHz Transducer.....	6
3	Device Manager with COM Port Name	7
4	TDC1000-C2000 GUI	8
5	EVM J5 and J2 Connectors	9
6	EVM LEDs.....	10
7	EVM GRAPH.....	10
8	TOF of Water in Test Cell	11
9	EVM GUI - TDC1000 Tap.....	12
10	START, COMPIN and STOP Signals on Oscilloscope	13
11	Top Assembly Layer	14
12	Top Layer Routing	15
13	Power Layer Routing	16
14	Ground Layer Routing	17
15	Bottom Layer Routing (Flipped)	18
16	Schematic 1	19
17	Schematic 2	20
18	Schematic 3	21

List of Tables

1	TDC1000-C2000EVM Bill of Materials	22
---	--	----

General Description

This guide details the use of the TDC1000-C2000EVM evaluation module (referred to as EVM for the remainder of this document). The TDC1000-C2000EVM is an evaluation module that allows users to evaluate the operation and performance of the TDC1000-Q1 ultrasonic analog-front-end with C2000 Real-Time Control microcontroller. The board can be used for many ultrasonic sensing applications such as automotive fluid level detection, concentration and fluid identification, and proximity or distance measurements. The EVM allows for two ultrasonic transducer connections, and two Resistance Temperature Detectors (RTD) connections for temperature measurements. The EVM comes with a user-friendly Graphic User Interface (GUI) to modify the registers and display the data.

1 EVM Key Features

1. Evaluate TDC1000 Ultrasonic Analog-Front-End (AFE)
2. On-board C2000-TMS320F28035PAG Microcontroller
3. User Friendly TDC1000-C2000 GUI interface
4. Ports for two Ultrasonic Transducers
5. Ports for two RTD Sensors
6. Powered by USB

1.1 EVM

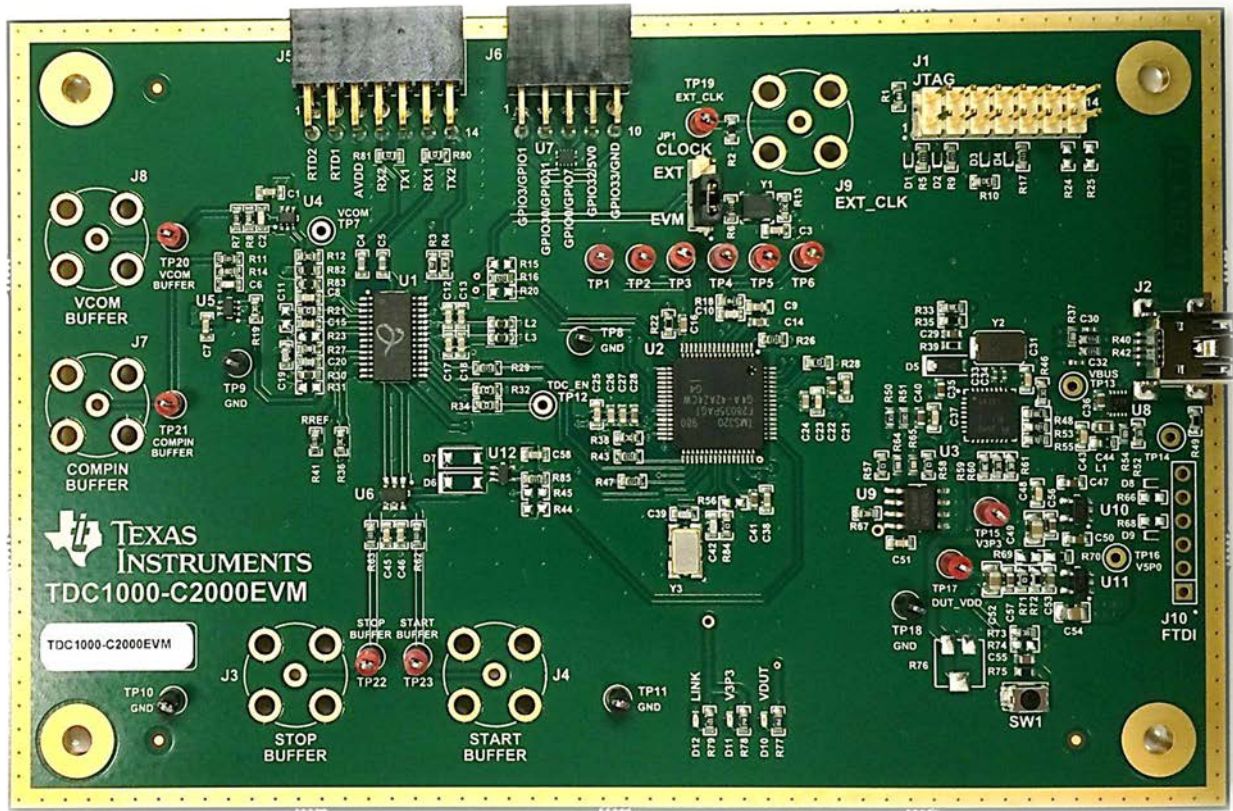

Figure 1. TDC1000-C2000EVM Evaluation Board

2 Equipment List

1. TDC1000-C2000EVM or TIDA-00322EVM
2. TDC1000-C2000 GUI
3. Mini-USB cable
4. PC with Windows XP or Windows 7
5. Transducer (also known as an ultrasonic sensor)
 - (a) For water application, we recommend STEMiNC's 1-Mhz transducer (p/n SMD10T2R111). The sensor should be mounted in a water container. An acrylic container that we recommend can be purchased from Tap Plastics. The example in this user guide uses a 30 mm × 30 mm × 50 mm acrylic container with the STEMiNC's transducer mounted on the side (see [Figure 2](#)).



Figure 2. Water Container with 1-MHz Transducer

- (b) For air application, we recommend Murata's 40kHz transducer (p/n MA40H1S-R) or ProWave's 40 kHz transducer (p/n 400PT160).

3 Quick Start

1. Download and Install TDC1000-C2000EVM (GUI) Software.
2. Fill a test cell with water. Make sure the water level is above the transducer.
3. Connect the test cell to TX1 and GND via J5 connector.
4. Connect the EVM board with a mini USB cable to the PC
5. Launch the GUI.
6. On the "GRAPH" tab, press the "START GRAPH" button.
7. The time of flight should be read in the TDC AVG VALUE section will show the TOF

4 Software Installation

This section describes software installation, firmware upgrade, and updating USB Driver.

4.1 Graphical User Interface (GUI)

Steps to install Windows GUI Installation file (version v1.0.2.59)

1. The latest Software for the EVM can be downloaded from the following locations:
 - (a) TDC1000-Q1 Tools and Software (<http://www.ti.com/product/TDC1000-Q1/toolssoftware>) or
 - (b) TIDA-00322 (<http://www.ti.com/tool/TIDA-00322>)
2. Notes on the software:
 - (a) The software must be installed before connecting the boards to the PC.
 - (b) The software is compatible with Windows XP and Windows 7.
3. Unzip the software folder
4. Run the “setup.exe” file
5. Follow the on-screen instructions to install the software. When the installation completes, click the “Finish” button to exit.

4.2 Installing the Driver

1. To download the UART driver, go to <http://www.ti.com/product/tusb3410/toolssoftware> >>
2. Download the “TI WDF USBUART Single Driver” to your PC.
3. Connect the USB cable from the TDC1000-C2000EVM (J2) to a Windows7 PC/Laptop.
4. On your computer, right click on “My Computer” and select “System Properties”. Open the Device Manager.
5. Scroll to Ports (COM & LPT) and expand this entry. Right click on “Ports (COM & LPT)”, then select “Scan for hardware changes”
6. Select the UART driver that you downloaded (step 2)
7. Once completed, you should be able to see “TUSB3410 Device (COM17)” as seen below.

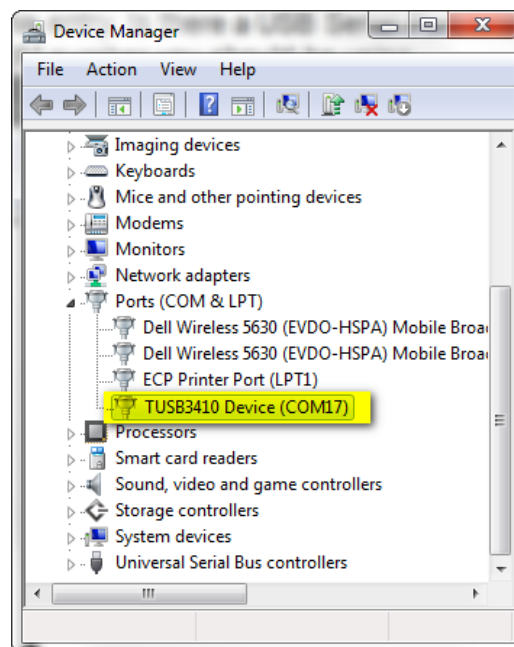

Figure 3. Device Manager with COM Port Name

4.3 Opening the GUI

1. Run the TDC1000_C2000 GUI from the “Start Menu”. By default it is located in “Programs\Texas Instruments\TDC1000_C2000”
2. GUI should automatically connect and show the following screen:

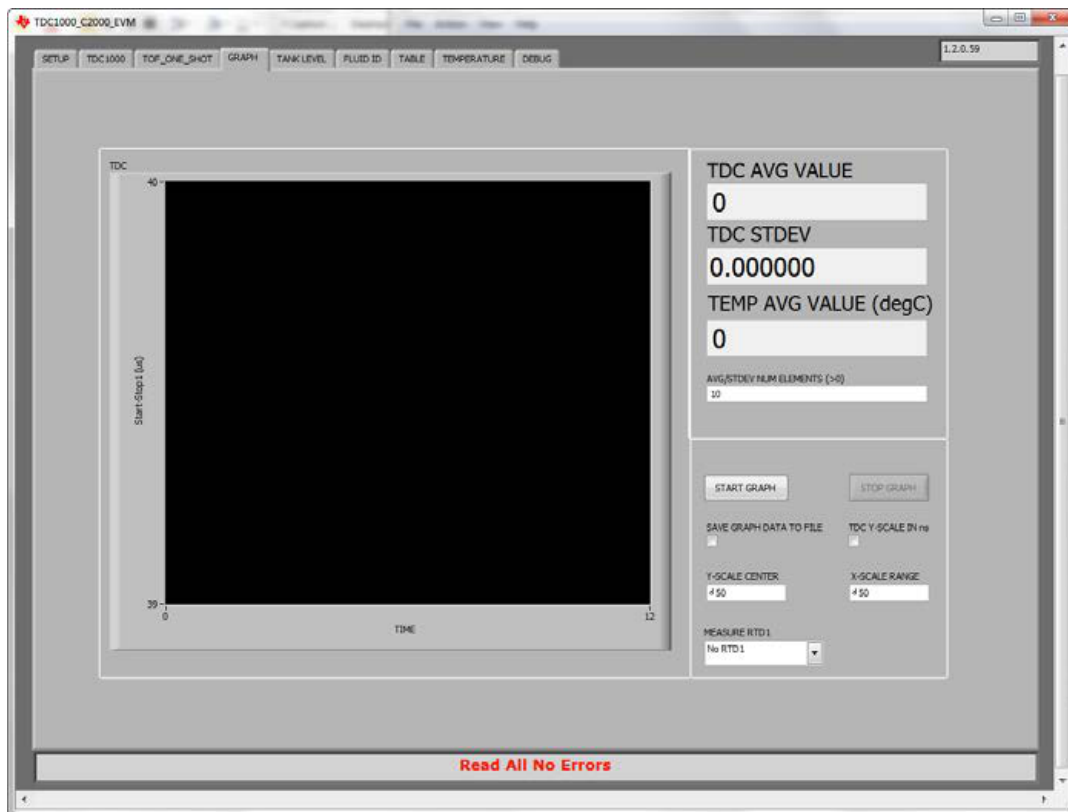

Figure 4. TDC1000-C2000 GUI

5 Hardware Configuration

This section describes how to properly set up the connections on the EVM.

5.1 EVM Connections

1. If you haven't done so, connect the USB cable to (J2) on the EVM and the other end of the cable to the PC.
2. Attach one of the transducer wires to the terminals TX1 (J5.P10) and the other side to any of the ground in (J5) connector (see [Figure 5](#)).

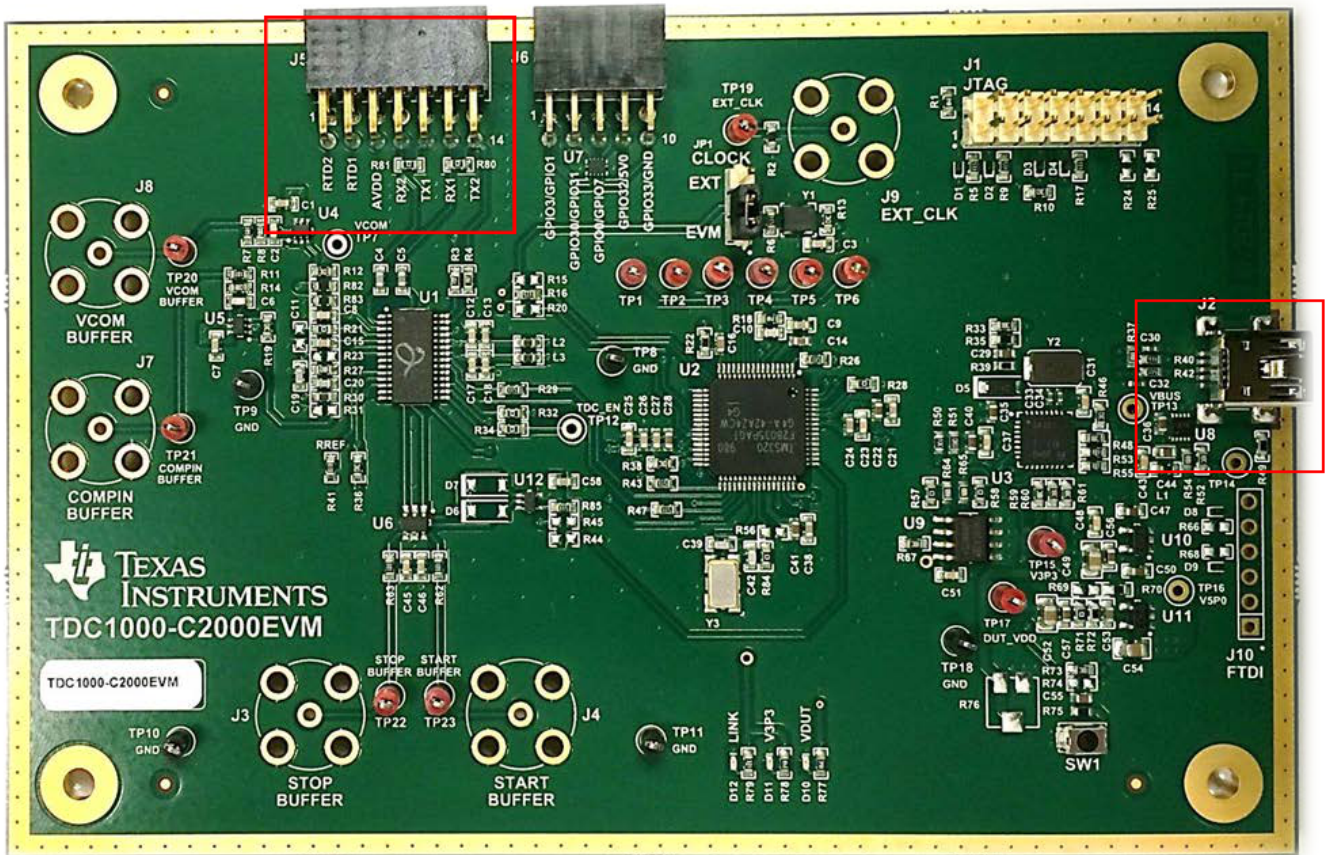

Figure 5. EVM J5 and J2 Connectors

5.2 Jumpers

For default operation, place jumpers on the following:

1. JP1.P1 - CLK-INT

5.3 LEDs

1. The V3p3 (D11) and VDUT (D10) LED are on if the board is powered.
2. If the 3p3V and DUT_VDD LED is off, check the physical connection to the PC.
3. The LINK LED is on if there is an established communication with the PC. If the LINK LED is blinking when the EVM is connected to the PC without the GUI running, then the crystal oscillator has a fault.

NOTE: The LINK LED will blink while the GRAPH in the GUI is running.

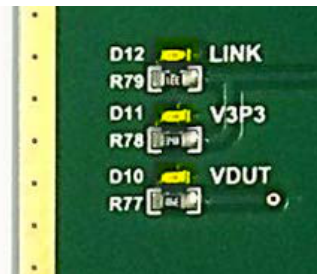

Figure 6. EVM LEDs

6 GUI and operation

1. The EVM GUI software can be run by clicking on Start >> All Programs >> Texas Instruments >> TDC1000_C2000.

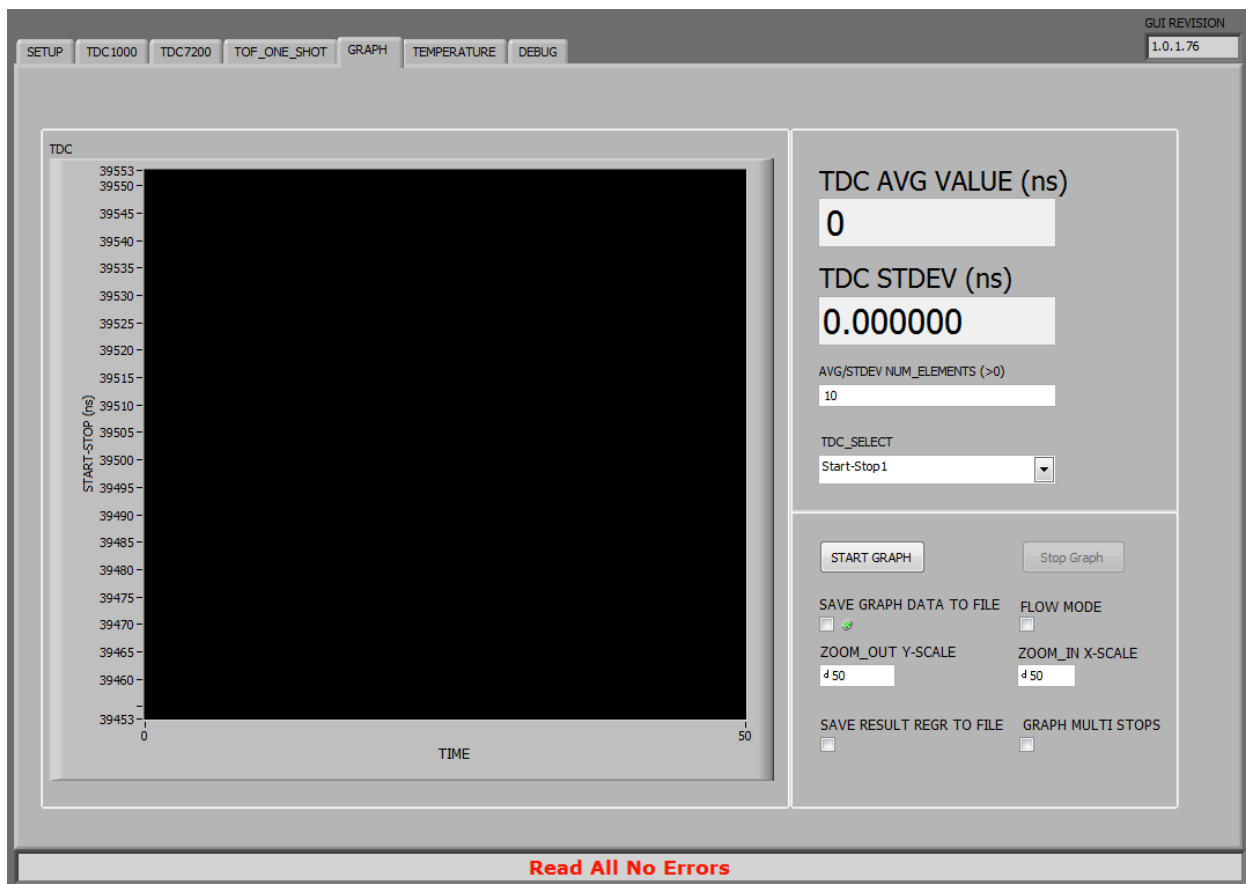

Figure 7. EVM GRAPH

2. The message at the bottom of [Figure 7](#) -- “**Read All No Errors**” -- means that the GUI is up and running and all the registers and hardware connection are correct. Otherwise, refer to [Section 4](#) and make sure to follow all the steps.
3. Go to the “GRAPH” tab on the TDC1000-C2000EVM GUI and click “START GRAPH”.
 - (a) If you are using a 30 mm x 30 mm x 50 mm acrylic water container with STEMiNC’s 1 MHz transducer mounted on the side (as discussed in [Section 2](#)), then you should be able to read the **TDC AVG VALUE ~40.8 μs** as shown below.

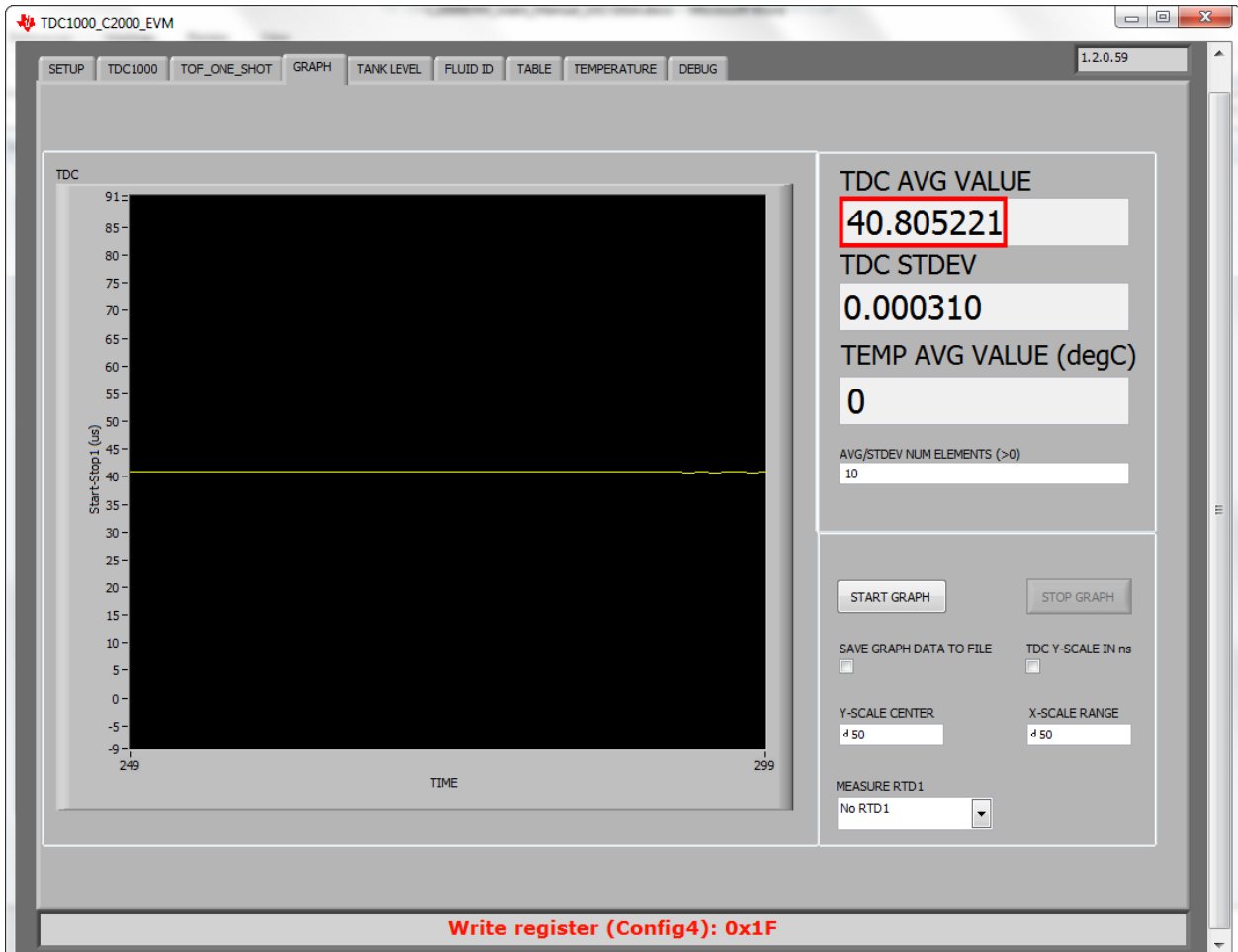

Figure 8. TOF of Water in Test Cell

4. If the substance under test experiences any disturbance, either by impurities being added or by shaking the container, the graph will represent this as a change on the TOF.

5. Follow the next steps to verify the TOF of the GUI on the oscilloscope.
 - (a) Enable constant trigger on the TDC1000 Tap on the GUI. The message "Start Continuous Trigger Successful!!" should appear at the bottom of the GUI (see Figure 9).
 - (b) Connect the oscilloscope to the following connector:
 - (i) START (J4)
 - (ii) STOP (J3)
 - (iii) COMP_IN (J7).

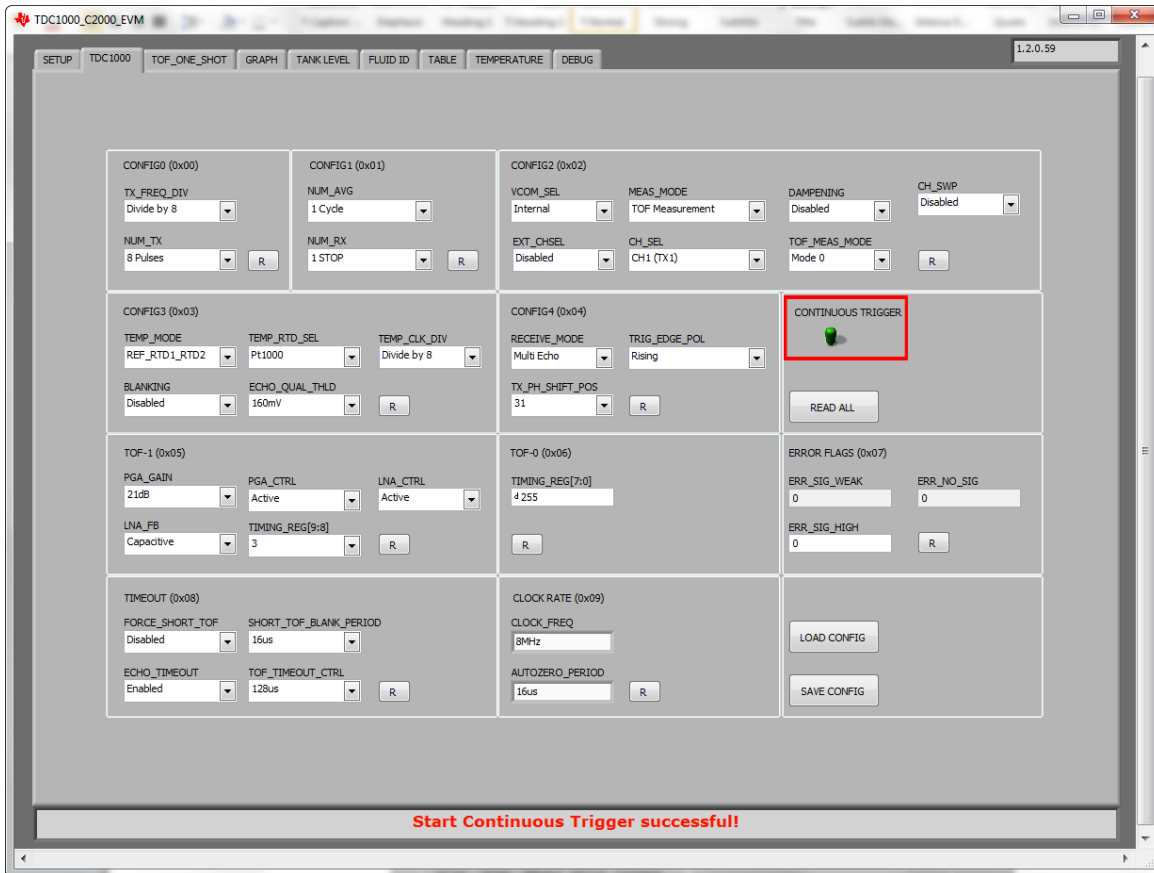

Figure 9. EVM GUI - TDC1000 Tap

NOTE: Each of the registers of this tap are explained in the TDC1000 datasheet



Figure 10. START, COMPIN and STOP Signals on Oscilloscope

6. Observe the START (pink), STOP (blue) and COMP_IN (green) signals on the oscilloscope and measure the time difference between the rising edge of the START signal to the rising edge of the STOP signal. Verify the time difference between the rising edge of the START signal to the rising edge of the STOP signal matches the "TDC AVG VALUE" on the GUI.
7. To verify TOF, use the following equation to find the width of the test cell. To corroborate the calculated value measure the test cell with a metric Caliper.

$$d = \frac{t}{2} v$$

where

- d is the width of the test cell
- t is the time of flight (TOF)
- v is the speed of sound through the medium (water = 1484 m/s at 23°C.)

For example, the TOF of the test cell filled with water is 40.805 μs would be calculated as follows:

$$d = \frac{40.805 \times 10^{-3} \text{ s}}{2} \times 1484 \text{ m/s} = 30.28 \text{ mm} \tag{2}$$

The acrylic water container test cell is therefore 30.28 mm wide.

7 Board Layout

NOTE: The board layout is not to scale. The following figures are intended to show how the board is laid out. It is not intended to be used for manufacturing.

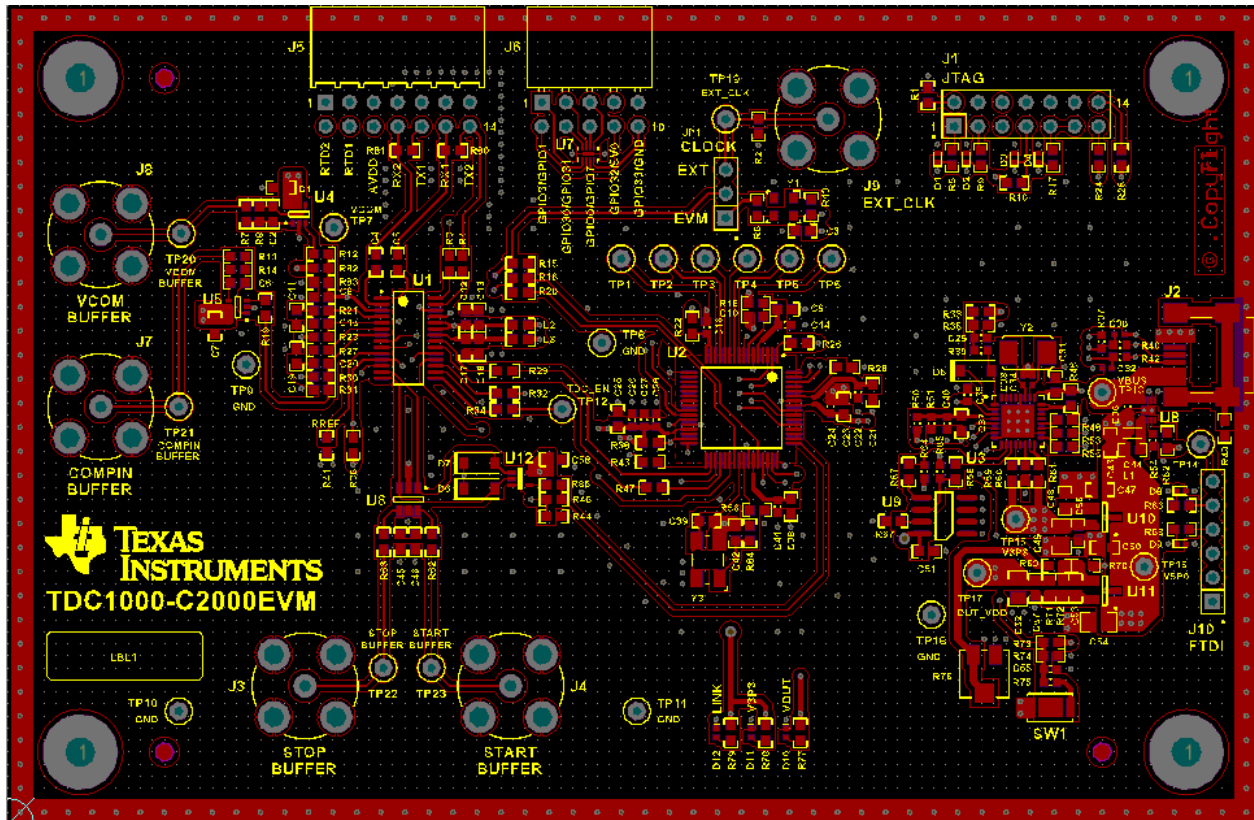

Figure 11. Top Assembly Layer

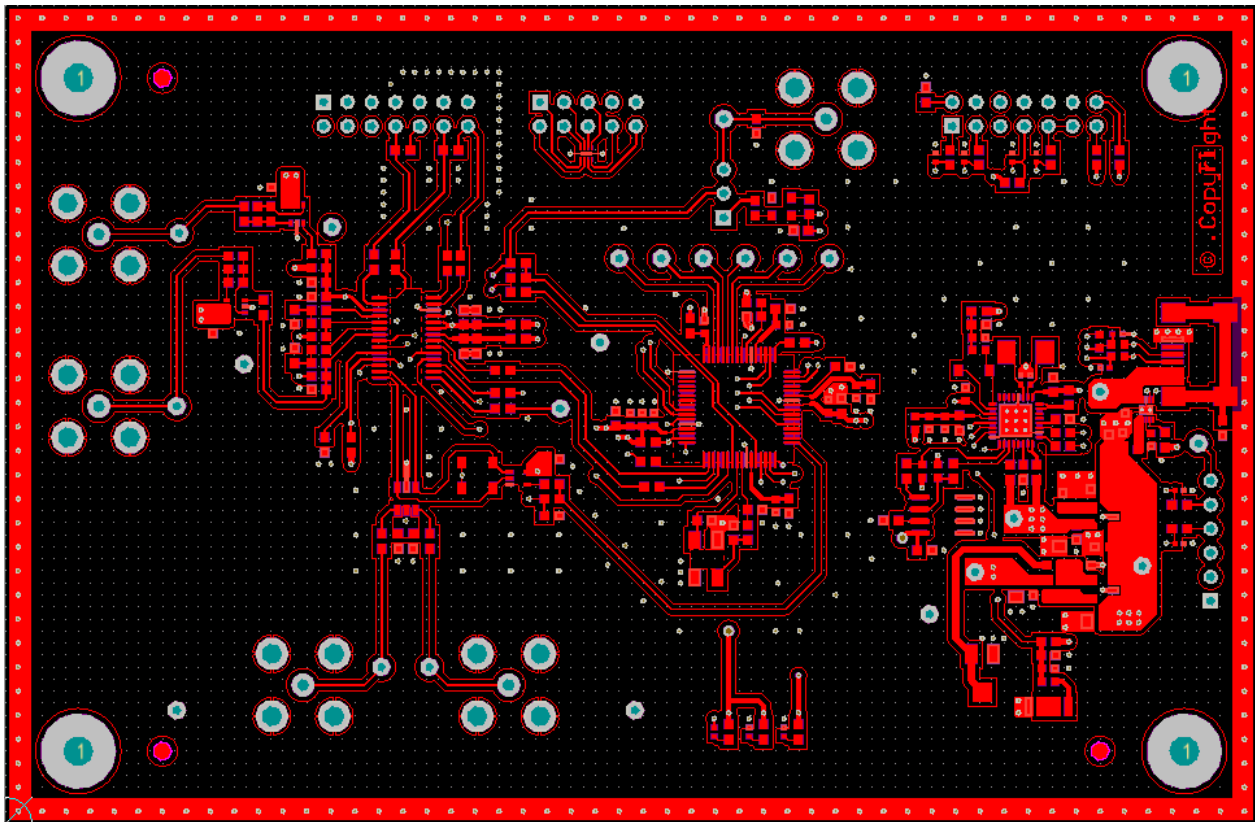

Figure 12. Top Layer Routing

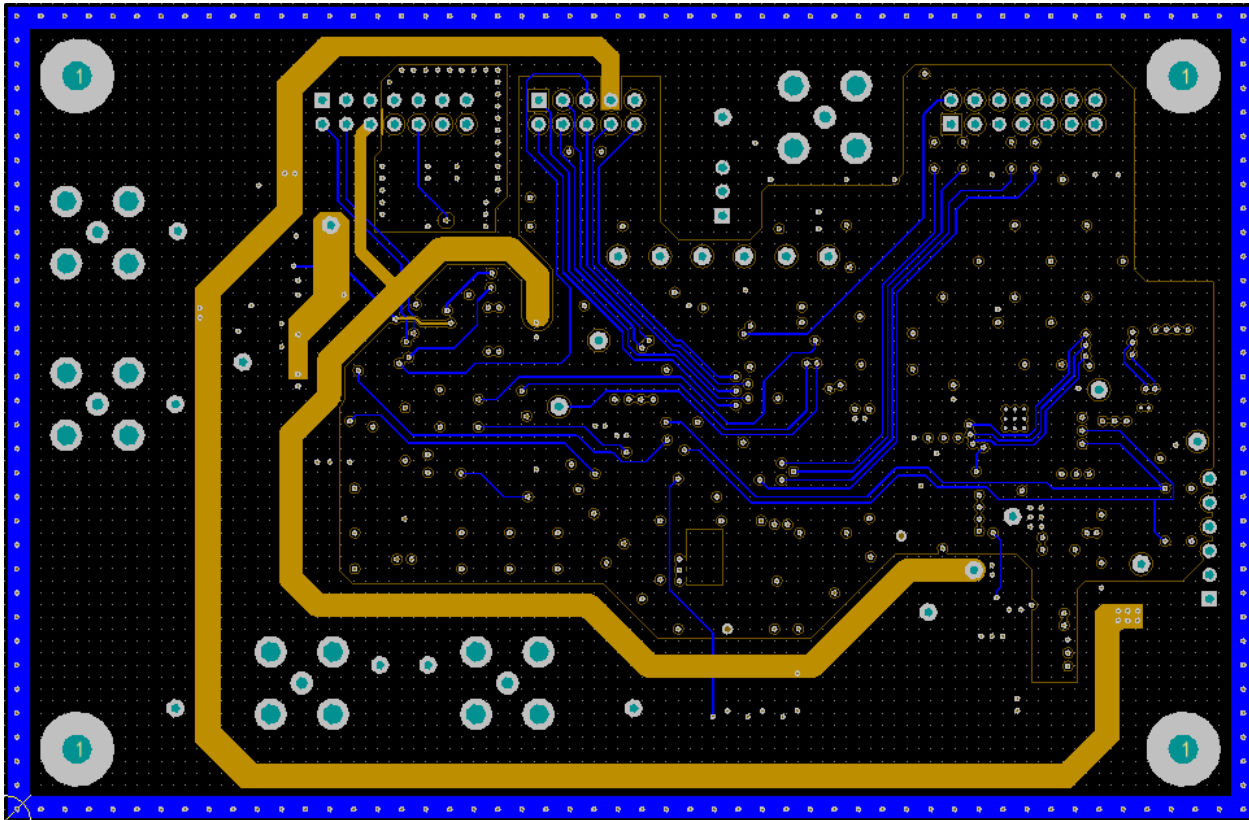

Figure 13. Power Layer Routing

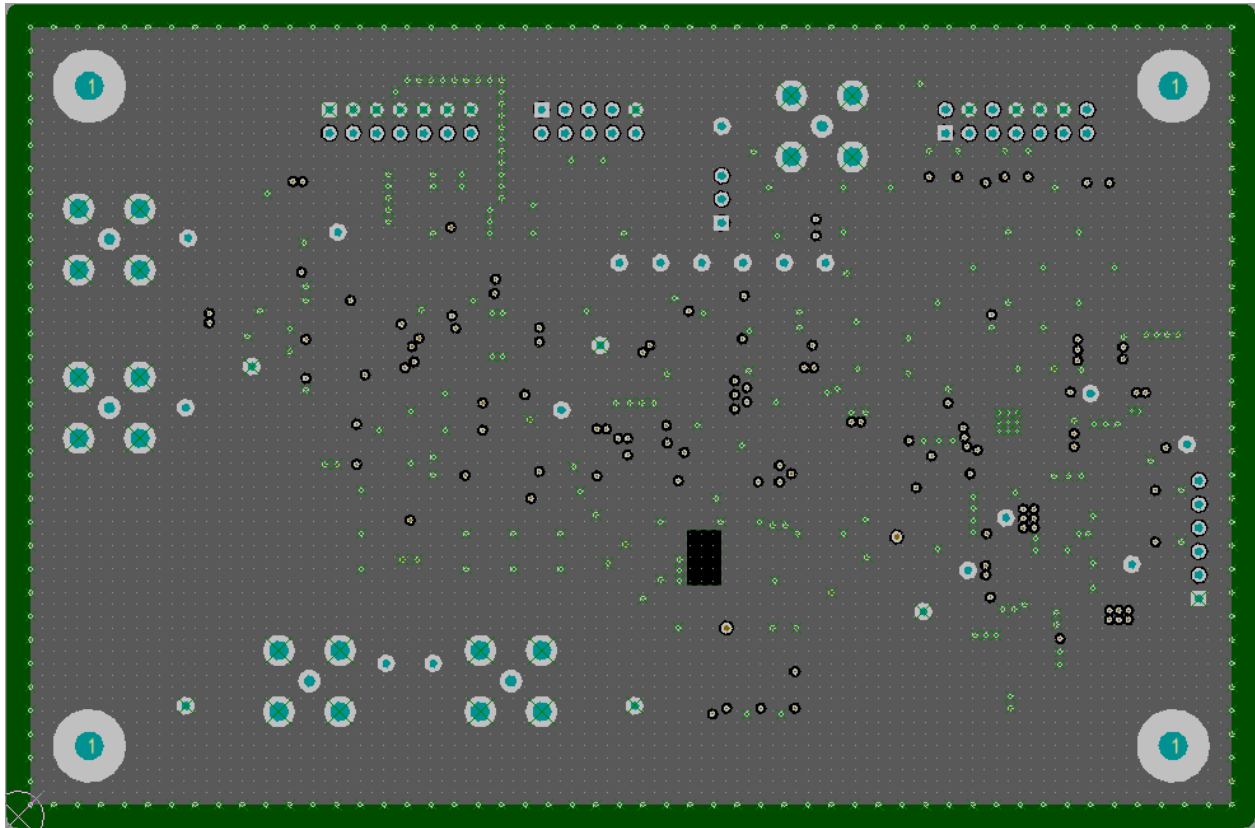

Figure 14. Ground Layer Routing

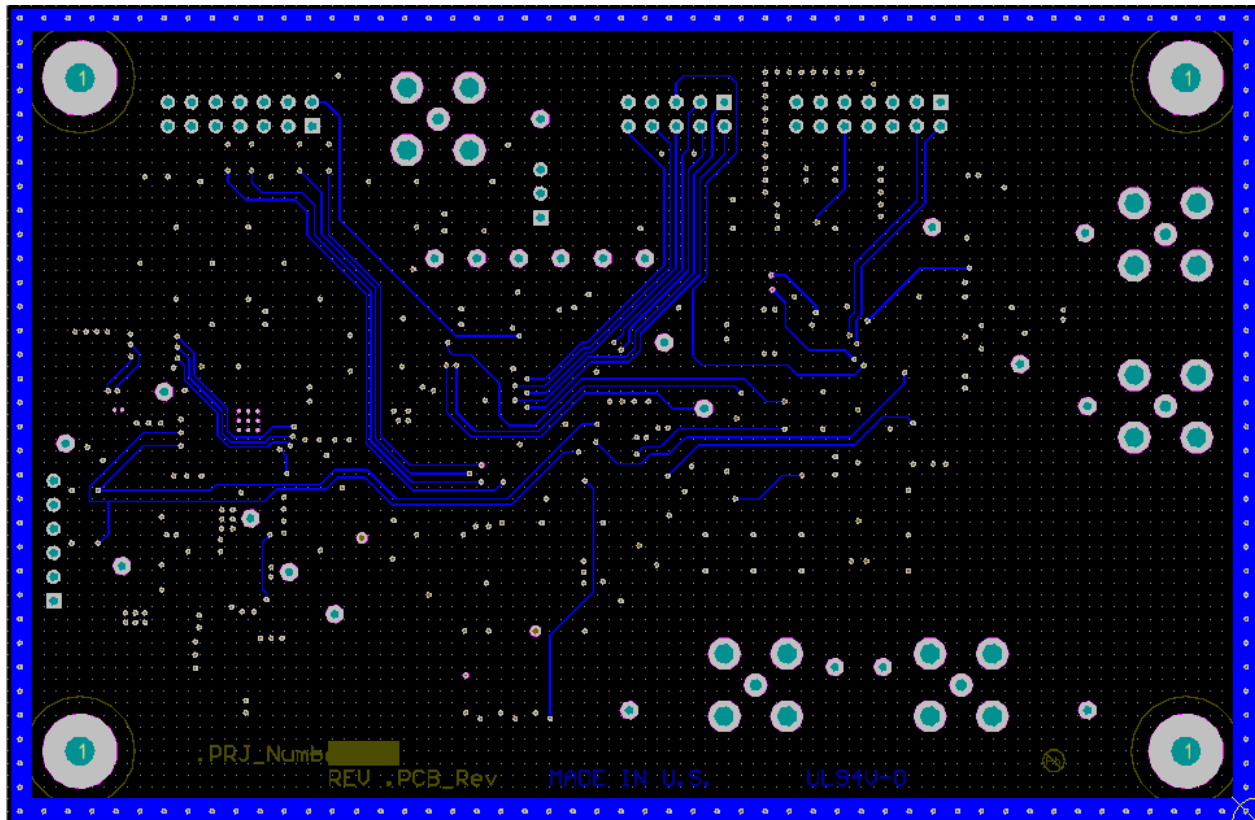

Figure 15. Bottom Layer Routing (Flipped)

8 Schematic

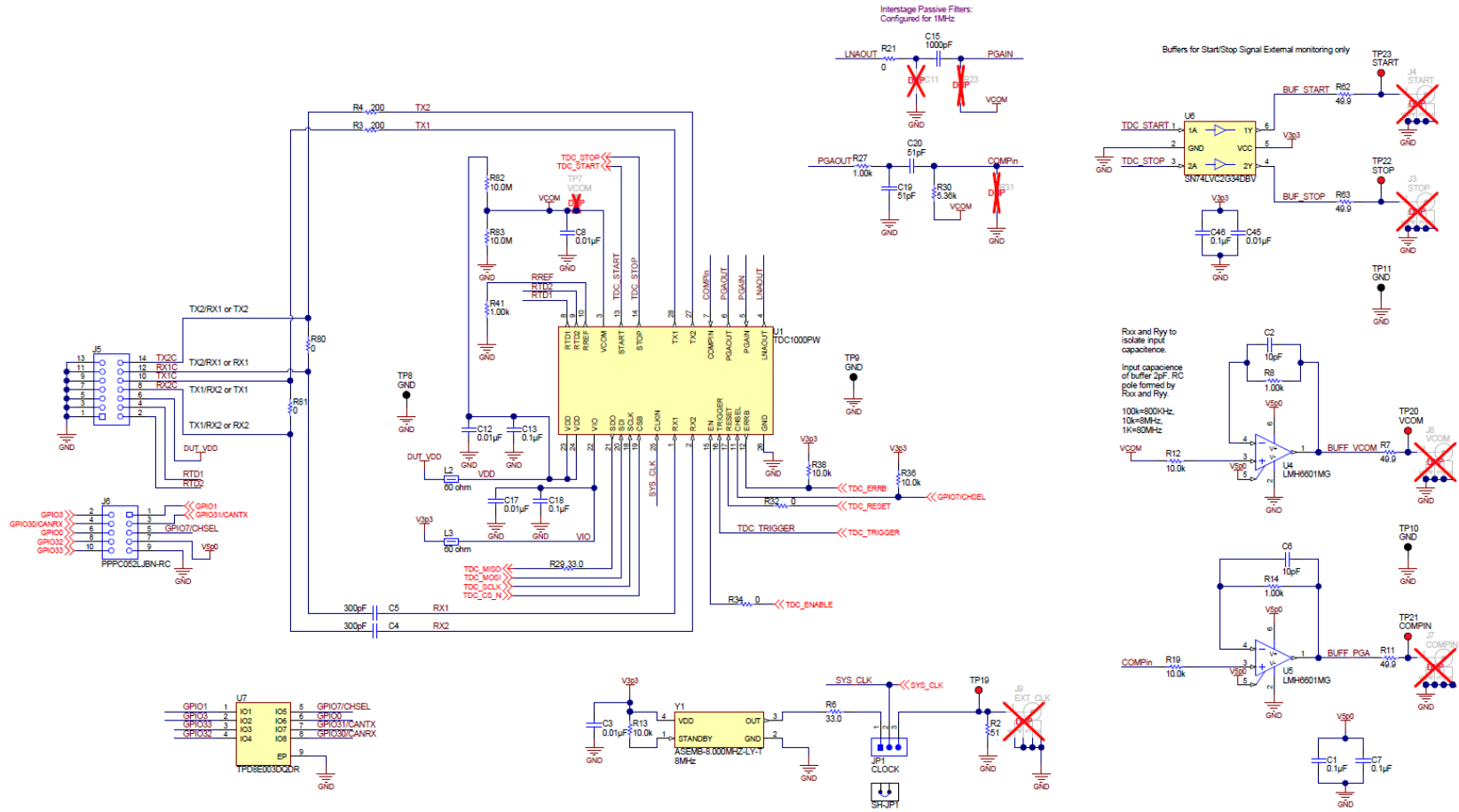

Figure 16. Schematic 1

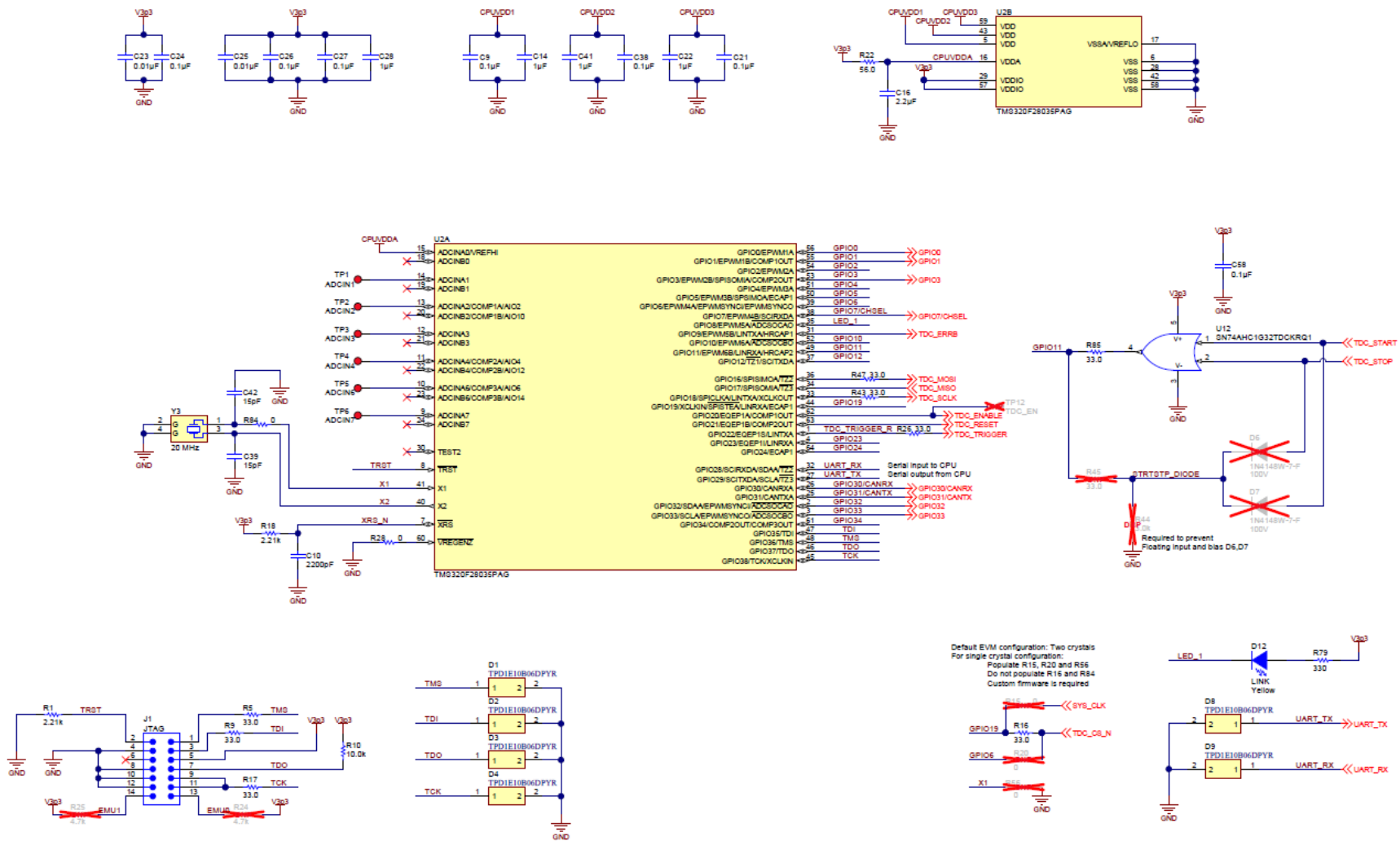

Figure 17. Schematic 2

9 Bill of Materials
Table 1. TDC1000-C2000EVM Bill of Materials

DESIGNATOR	QTY.	VALUE	DESCRIPTION	PACKAGE REFERENCE	PART NUMBER
EVM	1		TDC1000_C2000EVM		SV601136
C1, C7, C9, C13, C18, C21, C24, C26, C27, C38, C46	11	0.1 uF	CAP, CERM, 0.1uF, 16V, +/-5%, X7R, 0603	0603	0603YC104JAT2A
C2, C6	2	10 pF	CAP, CERM, 10pF, 50V, +/-5%, C0G/NP0, 0603	0603	06035A100JAT2A
C3, C8, C12, C17, C23, C25, C31, C37, C43, C45, C48, C51	12	0.01 uF	CAP, CERM, 0.01uF, 50V, +/-10%, X7R, 0603	0603	C1608X7R1H103K
C4, C5	2	300 pF	CAP, CERM, 300pF, 50V, +/-5%, C0G/NP0, 0603	0603	GRM1885C1H301JA01D
C10	1	2200 pF	CAP, CERM, 2200pF, 50V, +/-10%, X7R, 0603	0603	C0603X222K5RACTU
C14, C22, C28, C29, C35, C40, C44, C47, C50, C55, C56, C57	12	1 uF	CAP, CERM, 1uF, 10V, +/-10%, X7T, 0603	0603	GRM185D71A105KE36D
C15	1	1000 pF	CAP, CERM, 1000 pF, 50 V, +/- 5%, C0G/NP0, 0603	0603	C1608C0G1H102J
C16	1	2.2 uF	CAP, CERM, 2.2uF, 10V, +/-10%, X6S, 0603	0603	GRM188C81A225KE34D
C19, C20	2	51 pF	CAP, CERM, 51pF, 100V, +/-5%, C0G/NP0, 0603	0603	GRM1885C2A510JA01D
C30, C32	2	22 pF	CAP, CERM, 22pF, 50V, +/-5%, C0G/NP0, 0402	0402	GRM1555C1H220JA01D
C33, C34	2	33 pF	CAP, CERM, 33pF, 50V, +/-5%, C0G/NP0, 0402	0402	C0402C330J5GAC
C36, C41	2	1 uF	CAP, CERM, 1 uF, 10 V, +/- 10%, X7T, 0603	0603	GRM185D71A105KE36D
C39, C42	2	15 pF	CAP, CERM, 15pF, 50V, +/-5%, C0G/NP0, 0603	0603	06035A150JAT2A
C49, C52	2	10 uF	CAP, CERM, 10 uF, 10 V, +/- 10%, X7R, 0805	0805	GRM21BR71A106KE51L
C53	1	6.8 pF	CAP, CERM, 6.8pF, 50V, +/-4%, C0G/NP0, 0603	0603	06035A6R8CAT2A
C54	1	10 uF	CAP, CERM, 10uF, 10V, +/-10%, X7R, 0805	0805	GRM21BR71A106KE51L
C58	1	0.1 uF	CAP, CERM, 0.1 uF, 16 V, +/- 5%, X7R, 0603	0603	0603YC104JAT2A

Table 1. TDC1000-C2000EVM Bill of Materials (continued)

DESIGNATOR	QTY.	VALUE	DESCRIPTION	PACKAGE REFERENCE	PART NUMBER
D1, D2, D3, D4, D8, D9	6		ESD in 0402 Package with 10 pF Capacitance and 6 V Breakdown, 1 Channel, -40 to +125 degC, 2-pin X2SON (DPY), Green (RoHS & no Sb/Br)	DPY0002A	TPD1E10B06DPYR
D5	1	100 V	Diode, Ultrafast, 100V, 0.15A, SOD-123	SOD-123	1N4148W-7-F
D10, D11, D12	3	Yellow	LED, Yellow, SMD	Yellow LED	SML-P12YTT86
FID1, FID2, FID3	3		Fiducial mark. There is nothing to buy or mount.	Fiducial	N/A
H1, H2, H3, H4	4		Bumpon, Hemisphere, 0.44 X 0.20, Clear	Transparent Bumpon	SJ-5303 (CLEAR)
J1	1		Header, TH, 100mil, 7x2, Gold plated, 230 mil above insulator	7x2 Header	TSW-107-07-G-D
J2	1		MINI USB 2.0 SMT TYPE AB 5 CONTACTS R/A, SMD	9.2x9.9x4 mm	651-305-142-821
J5	1		Receptacle, 100mil, 7x2, Gold, R/A, TH	Receptacle, 7x2, 2.54mm, R/A, TH	SSW-107-02-G-D-RA
J6	1		Connector, Receptacle, 100mil, 5x2, Gold plated, R/A, TH	5x2 R/A Header Receptacle	PPPC052LJBN-RC
JP1	1		Header, TH, 100mil, 3x1, Gold plated, 230 mil above insulator	3x1 Header	TSW-103-07-G-S
L1, L2, L3	3	60 ohm	Ferrite Bead, 60 ohm @ 100MHz, 0.8A, 0603	0603	BK1608HS600-T
LBL1	1		Thermal Transfer Printable Labels, 0.650" W x 0.200" H - 10,000 per roll	PCB Label 0.650"H x 0.200"W	THT-14-423-10
R1, R18, R77, R78	4	2.21k	RES, 2.21k ohm, 1%, 0.1W, 0603	0603	CRCW06032K21FKEA
R2	1	51	RES, 51 ohm, 5%, 0.1W, 0603	0603	CRCW060351R0JNEA
R3, R4	2	200	RES, 200, 0.1%, 0.1 W, 0603	0603	RG1608P-201-B-T5
R5, R6, R9, R16, R17, R26, R29, R40, R42, R43, R47, R85	12	33.0	RES, 33.0 ohm, 1%, 0.1W, 0603	0603	CRCW060333R0FKEA
R7, R11	2	49.9	RES, 49.9 ohm, 1%, 0.1W, 0603	0603	CRCW060349R9FKEA
R8, R14, R27	3	1.00k	RES, 1.00k ohm, 1%, 0.1W, 0603	0603	CRCW06031K00FKEA
R10, R12, R13, R19, R36, R38, R46	7	10.0k	RES, 10.0k ohm, 1%, 0.1W, 0603	0603	RC0603FR-0710KL
R21, R28, R32, R34, R57, R58, R71, R80, R81	9	0	RES, 0 ohm, 5%, 0.1W, 0603	0603	CRCW06030000Z0EA
R22	1	56.0	RES, 56.0 ohm, 1%, 0.1W, 0603	0603	RC0603FR-0756RL

Table 1. TDC1000-C2000EVM Bill of Materials (continued)

DESIGNATOR	QTY.	VALUE	DESCRIPTION	PACKAGE REFERENCE	PART NUMBER
R30	1	5.36k	RES, 5.36 k, 1%, 0.1 W, 0603	0603	CRCW06035K36FKEA
R33, R48, R52, R59, R60, R61, R67, R73	8	15.0k	RES, 15.0k ohm, 1%, 0.1W, 0603	0603	CRCW060315K0FKEA
R35, R75	2	100	RES, 100 ohm, 1%, 0.1W, 0603	0603	CRCW0603100RFKEA
R37, R54, R64, R65	4	1.50k	RES, 1.50k ohm, 1%, 0.1W, 0603	0603	CRCW06031K50FKEA
R39, R49	2	33.0k	RES, 33.0k ohm, 1%, 0.1W, 0603	0603	CRCW060333K0FKEA
R41	1	1.00k	RES, 1.00 k, 0.01%, 0.063 W, 0603	0603	RNCF0603TKY1K00
R50	1	90.9k	RES, 90.9k ohm, 1%, 0.1W, 0603	0603	RC0603FR-0790K9L
R51	1	100k	RES, 100k ohm, 1%, 0.1W, 0603	0603	RC0603FR-07100KL
R53, R55, R79	3	330	RES, 330 ohm, 5%, 0.1W, 0603	0603	CRCW0603330RJNEA
R62, R63	2	49.9	RES, 49.9, 1%, 0.1 W, 0603	0603	CRCW060349R9FKEA
R70	1	51.1k	RES, 51.1k ohm, 1%, 0.1W, 0603	0603	CRCW060351K1FKEA
R72	1	143k	RES, 143k ohm, 1%, 0.1W, 0603	0603	CRCW0603143KFKEA
R82, R83	2	10.0Meg	RES, 10.0 M, 1%, 0.1 W, 0603	0603	CRCW060310M0FKEA
R84	1	0	RES, 0, 5%, 0.1 W, 0603	0603	CRCW06030000Z0EA
SH-JP1	1	1x2	Shunt, 100mil, Gold plated, Black	Shunt	969102-0000-DA
SW1	1		Switch, Push Button, SMD	2.9x2x3.9mm SMD	SKRKAE010
TP1, TP2, TP3, TP4, TP5, TP6, TP15, TP17, TP19, TP20, TP21, TP22, TP23	13	Red	Test Point, Miniature, Red, TH	Red Miniature Testpoint	5000
TP8, TP9, TP10, TP11, TP18	5	Black	Test Point, Miniature, Black, TH	Black Miniature Testpoint	5001
U1	1		TDC1000 Precision AFE for Time of Flight, PW0028A	PW0028A	TDC1000PW
U2	1		Piccolo(TM) Microcontrollers, PAG0064A	PAG0064A	TMS320F28035PAG
U3	1	TUSB3410	RS232 / IrDA Serial-to-USB Converter, 2 MIPs, 16 KBytes, 8052, 3.3V, -40 to 85 degC, 32-Pin QFN (RHB), Green (RoHS & no Sb/Br)	RHB0032E	TUSB3410IRHB
U4, U5	2	LMH6601MG	2.4V R-R Out CMOS Video Op Amp with Shutdown	MAA06A_L	LMH6601MG
U6	1		Dual Buffer Gate, DBV0006A	DBV0006A	SN74LVC2G34DBV

Table 1. TDC1000-C2000EVM Bill of Materials (continued)

DESIGNATOR	QTY.	VALUE	DESCRIPTION	PACKAGE REFERENCE	PART NUMBER
U7	1		ESD Array For Portable Space-Saving Applications, 8 Channels, -40 to +85 degC, 8-pin WSON (DQD), Green (RoHS & no Sb/Br)	DQD0008A	TPD8E003DQDR
U8	1	TPD4S014	Complete USB Port Protection Device, 4 Channels, -40 to +85 degC, 10-pin SON (DSQ), Green (RoHS & no Sb/Br)	DSQ0010A	TPD4S014DSQR
U9	1		128-Kbit Serial I2C Bus EEPROM, SOIC-8	SOIC-8	M24128-BWMN6TP
U10	1		Micropower 150 mA Low-Noise Ultra Low-Dropout Regulator, 5-pin SOT-23, Pb-Free	MF05A	LP2985AIM5-3.3/NOPB
U11	1		Micropower 50 mA Ultra Low-Dropout Adjustable Voltage Regulator, 5-pin SOT-23	MF05A	LP2980IM5X-ADJ
U12	1		SINGLE 2-INPUT POSITIVE-OR GATE, DCK0005A	DCK0005A	SN74AHC1G32TDCK RQ1
Y1	1		OSC, 8 MHz, 1.8 - 3.3V, SMD	4-Pin SMD, Body 3.2 x 2.5 mm , Height 0.9 mm	ASEMB-8.000MHZ-LY-T
Y2	1	815-ABM3-12-B2-T	Crystal, 12Mhz, 18pF, SMD	ABM3	ABM3-12.000MHZ-B2-T
Y3	1		Crystal, 20 MHz, 10 pF, SMD	Crystal, 3.2x1.1x5.x mm	ABM3B-20.000MHZ-10-1-U-T
C11	0		CAP, CERM, xxxF, xxV, [TempCo], xx%, [PackageReference]	Used in PnP output	Used in BOM report
D6, D7	0	100V	Diode, Ultrafast, 100V, 0.15A, SOD-123	SOD-123	1N4148W-7-F
J3, J4, J7, J8, J9	0		Connector, TH, BNC	Amphenol_112404	112404
J10	0		Header, TH, 100mil, 6x1, Gold plated, 230 mil above insulator	6x1 Header	TSW-106-07-G-S
R15, R56	0	0	RES, 0 ohm, 5%, 0.1W, 0603	0603	CRCW06030000Z0EA
R20	0	0	RES, 33 ohm, 5%, 0.1W, 0603	0603	CRCW060333R0JNEA
R23	0		RES, xxx ohm, x%, xW, [PackageReference]	Used in PnP output	Used in BOM report
R24, R25	0	4.7k	RES, 4.7 k, 5%, 0.1 W, 0603	0603	CRCW06034K70JNEA
R31	0		RES, xxx ohm, x%, xW, [PackageReference]	Used in PnP output	Used in BOM report
R44	0	3.0k	RES, 3.0k ohm, 5%, 0.1W, 0603	0603	CRCW06033K00JNEA
R45	0	33.0	RES, 33.0 ohm, 1%, 0.1W, 0603	0603	CRCW060333R0FKEA

Table 1. TDC1000-C2000EVM Bill of Materials (continued)

DESIGNATOR	QTY.	VALUE	DESCRIPTION	PACKAGE REFERENCE	PART NUMBER
R66, R68	0	0	RES, 0, 5%, 0.1 W, 0603	0603	MCR03EZPJ000
R69	0	1.00k	RES, 1.00k ohm, 1%, 0.1W, 0603	0603	CRCW06031K00FKEA
R74	0	0	RES, 0 ohm, 5%, 0.1W, 0603	0603	ERJ-3GEY0R00V
R76	0	100k	TRIMMER, 100K, 0.25W, SMD	4.8x3.71x4.6mm	3224J-1-104E
TP7, TP12, TP13, TP14, TP16	0	Red	Test Point, Miniature, Red, TH	Red Miniature Testpoint	5000

STANDARD TERMS AND CONDITIONS FOR EVALUATION MODULES

1. *Delivery:* TI delivers TI evaluation boards, kits, or modules, including any accompanying demonstration software, components, or documentation (collectively, an "EVM" or "EVMs") to the User ("User") in accordance with the terms and conditions set forth herein. Acceptance of the EVM is expressly subject to the following terms and conditions.
 - 1.1 EVMs are intended solely for product or software developers for use in a research and development setting to facilitate feasibility evaluation, experimentation, or scientific analysis of TI semiconductor products. EVMs have no direct function and are not finished products. EVMs shall not be directly or indirectly assembled as a part or subassembly in any finished product. For clarification, any software or software tools provided with the EVM ("Software") shall not be subject to the terms and conditions set forth herein but rather shall be subject to the applicable terms and conditions that accompany such Software
 - 1.2 EVMs are not intended for consumer or household use. EVMs may not be sold, sublicensed, leased, rented, loaned, assigned, or otherwise distributed for commercial purposes by Users, in whole or in part, or used in any finished product or production system.
2. *Limited Warranty and Related Remedies/Disclaimers:*
 - 2.1 These terms and conditions do not apply to Software. The warranty, if any, for Software is covered in the applicable Software License Agreement.
 - 2.2 TI warrants that the TI EVM will conform to TI's published specifications for ninety (90) days after the date TI delivers such EVM to User. Notwithstanding the foregoing, TI shall not be liable for any defects that are caused by neglect, misuse or mistreatment by an entity other than TI, including improper installation or testing, or for any EVMs that have been altered or modified in any way by an entity other than TI. Moreover, TI shall not be liable for any defects that result from User's design, specifications or instructions for such EVMs. Testing and other quality control techniques are used to the extent TI deems necessary or as mandated by government requirements. TI does not test all parameters of each EVM.
 - 2.3 If any EVM fails to conform to the warranty set forth above, TI's sole liability shall be at its option to repair or replace such EVM, or credit User's account for such EVM. TI's liability under this warranty shall be limited to EVMs that are returned during the warranty period to the address designated by TI and that are determined by TI not to conform to such warranty. If TI elects to repair or replace such EVM, TI shall have a reasonable time to repair such EVM or provide replacements. Repaired EVMs shall be warranted for the remainder of the original warranty period. Replaced EVMs shall be warranted for a new full ninety (90) day warranty period.
3. *Regulatory Notices:*
 - 3.1 *United States*
 - 3.1.1 *Notice applicable to EVMs not FCC-Approved:*

This kit is designed to allow product developers to evaluate electronic components, circuitry, or software associated with the kit to determine whether to incorporate such items in a finished product and software developers to write software applications for use with the end product. This kit is not a finished product and when assembled may not be resold or otherwise marketed unless all required FCC equipment authorizations are first obtained. Operation is subject to the condition that this product not cause harmful interference to licensed radio stations and that this product accept harmful interference. Unless the assembled kit is designed to operate under part 15, part 18 or part 95 of this chapter, the operator of the kit must operate under the authority of an FCC license holder or must secure an experimental authorization under part 5 of this chapter.
 - 3.1.2 *For EVMs annotated as FCC – FEDERAL COMMUNICATIONS COMMISSION Part 15 Compliant:*

CAUTION

This device complies with part 15 of the FCC Rules. Operation is subject to the following two conditions: (1) This device may not cause harmful interference, and (2) this device must accept any interference received, including interference that may cause undesired operation.

Changes or modifications not expressly approved by the party responsible for compliance could void the user's authority to operate the equipment.

FCC Interference Statement for Class A EVM devices

NOTE: This equipment has been tested and found to comply with the limits for a Class A digital device, pursuant to part 15 of the FCC Rules. These limits are designed to provide reasonable protection against harmful interference when the equipment is operated in a commercial environment. This equipment generates, uses, and can radiate radio frequency energy and, if not installed and used in accordance with the instruction manual, may cause harmful interference to radio communications. Operation of this equipment in a residential area is likely to cause harmful interference in which case the user will be required to correct the interference at his own expense.

FCC Interference Statement for Class B EVM devices

NOTE: This equipment has been tested and found to comply with the limits for a Class B digital device, pursuant to part 15 of the FCC Rules. These limits are designed to provide reasonable protection against harmful interference in a residential installation. This equipment generates, uses and can radiate radio frequency energy and, if not installed and used in accordance with the instructions, may cause harmful interference to radio communications. However, there is no guarantee that interference will not occur in a particular installation. If this equipment does cause harmful interference to radio or television reception, which can be determined by turning the equipment off and on, the user is encouraged to try to correct the interference by one or more of the following measures:

- Reorient or relocate the receiving antenna.
- Increase the separation between the equipment and receiver.
- Connect the equipment into an outlet on a circuit different from that to which the receiver is connected.
- Consult the dealer or an experienced radio/TV technician for help.

3.2 Canada

3.2.1 For EVMs issued with an Industry Canada Certificate of Conformance to RSS-210

Concerning EVMs Including Radio Transmitters:

This device complies with Industry Canada license-exempt RSS standard(s). Operation is subject to the following two conditions: (1) this device may not cause interference, and (2) this device must accept any interference, including interference that may cause undesired operation of the device.

Concernant les EVMs avec appareils radio:

Le présent appareil est conforme aux CNR d'Industrie Canada applicables aux appareils radio exempts de licence. L'exploitation est autorisée aux deux conditions suivantes: (1) l'appareil ne doit pas produire de brouillage, et (2) l'utilisateur de l'appareil doit accepter tout brouillage radioélectrique subi, même si le brouillage est susceptible d'en compromettre le fonctionnement.

Concerning EVMs Including Detachable Antennas:

Under Industry Canada regulations, this radio transmitter may only operate using an antenna of a type and maximum (or lesser) gain approved for the transmitter by Industry Canada. To reduce potential radio interference to other users, the antenna type and its gain should be so chosen that the equivalent isotropically radiated power (e.i.r.p.) is not more than that necessary for successful communication. This radio transmitter has been approved by Industry Canada to operate with the antenna types listed in the user guide with the maximum permissible gain and required antenna impedance for each antenna type indicated. Antenna types not included in this list, having a gain greater than the maximum gain indicated for that type, are strictly prohibited for use with this device.

Concernant les EVMs avec antennes détachables

Conformément à la réglementation d'Industrie Canada, le présent émetteur radio peut fonctionner avec une antenne d'un type et d'un gain maximal (ou inférieur) approuvé pour l'émetteur par Industrie Canada. Dans le but de réduire les risques de brouillage radioélectrique à l'intention des autres utilisateurs, il faut choisir le type d'antenne et son gain de sorte que la puissance isotrope rayonnée équivalente (p.i.r.e.) ne dépasse pas l'intensité nécessaire à l'établissement d'une communication satisfaisante. Le présent émetteur radio a été approuvé par Industrie Canada pour fonctionner avec les types d'antenne énumérés dans le manuel d'usage et ayant un gain admissible maximal et l'impédance requise pour chaque type d'antenne. Les types d'antenne non inclus dans cette liste, ou dont le gain est supérieur au gain maximal indiqué, sont strictement interdits pour l'exploitation de l'émetteur.

3.3 Japan

3.3.1 *Notice for EVMs delivered in Japan:* Please see http://www.tij.co.jp/lstds/ti_ja/general/eStore/notice_01.page 日本国内に輸入される評価用キット、ボードについては、次のところをご覧ください。
http://www.tij.co.jp/lstds/ti_ja/general/eStore/notice_01.page

3.3.2 *Notice for Users of EVMs Considered "Radio Frequency Products" in Japan:* EVMs entering Japan are NOT certified by TI as conforming to Technical Regulations of Radio Law of Japan.

If User uses EVMs in Japan, User is required by Radio Law of Japan to follow the instructions below with respect to EVMs:

1. Use EVMs in a shielded room or any other test facility as defined in the notification #173 issued by Ministry of Internal Affairs and Communications on March 28, 2006, based on Sub-section 1.1 of Article 6 of the Ministry's Rule for Enforcement of Radio Law of Japan,
2. Use EVMs only after User obtains the license of Test Radio Station as provided in Radio Law of Japan with respect to EVMs, or
3. Use of EVMs only after User obtains the Technical Regulations Conformity Certification as provided in Radio Law of Japan with respect to EVMs. Also, do not transfer EVMs, unless User gives the same notice above to the transferee. Please note that if User does not follow the instructions above, User will be subject to penalties of Radio Law of Japan.

【無線電波を送信する製品の開発キットをお使いになる際の注意事項】

本開発キットは技術基準適合証明を受けておりません。

本製品のご使用に際しては、電波法遵守のため、以下のいずれかの措置を取っていただく必要がありますのでご注意ください。

1. 電波法施行規則第6条第1項第1号に基づく平成18年3月28日総務省告示第173号で定められた電波暗室等の試験設備でご使用いただく。
2. 実験局の免許を取得後ご使用いただく。
3. 技術基準適合証明を取得後ご使用いただく。

なお、本製品は、上記の「ご使用にあたっての注意」を譲渡先、移転先に通知しない限り、譲渡、移転できないものとします。

上記を遵守頂けない場合は、電波法の罰則が適用される可能性があることをご留意ください。

日本テキサス・インスツルメンツ株式会社

東京都新宿区西新宿 6 丁目 2 4 番 1 号

西新宿三井ビル

3.3.3 *Notice for EVMs for Power Line Communication:* Please see http://www.tij.co.jp/llds/ti_ja/general/eStore/notice_02.page

電力線搬送波通信についての開発キットをお使いになる際の注意事項については、次のところをご覧ください。http://www.tij.co.jp/llds/ti_ja/general/eStore/notice_02.page

4 *EVM Use Restrictions and Warnings:*

4.1 EVMS ARE NOT FOR USE IN FUNCTIONAL SAFETY AND/OR SAFETY CRITICAL EVALUATIONS, INCLUDING BUT NOT LIMITED TO EVALUATIONS OF LIFE SUPPORT APPLICATIONS.

4.2 User must read and apply the user guide and other available documentation provided by TI regarding the EVM prior to handling or using the EVM, including without limitation any warning or restriction notices. The notices contain important safety information related to, for example, temperatures and voltages.

4.3 *Safety-Related Warnings and Restrictions:*

4.3.1 User shall operate the EVM within TI's recommended specifications and environmental considerations stated in the user guide, other available documentation provided by TI, and any other applicable requirements and employ reasonable and customary safeguards. Exceeding the specified performance ratings and specifications (including but not limited to input and output voltage, current, power, and environmental ranges) for the EVM may cause personal injury or death, or property damage. If there are questions concerning performance ratings and specifications, User should contact a TI field representative prior to connecting interface electronics including input power and intended loads. Any loads applied outside of the specified output range may also result in unintended and/or inaccurate operation and/or possible permanent damage to the EVM and/or interface electronics. Please consult the EVM user guide prior to connecting any load to the EVM output. If there is uncertainty as to the load specification, please contact a TI field representative. During normal operation, even with the inputs and outputs kept within the specified allowable ranges, some circuit components may have elevated case temperatures. These components include but are not limited to linear regulators, switching transistors, pass transistors, current sense resistors, and heat sinks, which can be identified using the information in the associated documentation. When working with the EVM, please be aware that the EVM may become very warm.

4.3.2 EVMs are intended solely for use by technically qualified, professional electronics experts who are familiar with the dangers and application risks associated with handling electrical mechanical components, systems, and subsystems. User assumes all responsibility and liability for proper and safe handling and use of the EVM by User or its employees, affiliates, contractors or designees. User assumes all responsibility and liability to ensure that any interfaces (electronic and/or mechanical) between the EVM and any human body are designed with suitable isolation and means to safely limit accessible leakage currents to minimize the risk of electrical shock hazard. User assumes all responsibility and liability for any improper or unsafe handling or use of the EVM by User or its employees, affiliates, contractors or designees.

4.4 User assumes all responsibility and liability to determine whether the EVM is subject to any applicable international, federal, state, or local laws and regulations related to User's handling and use of the EVM and, if applicable, User assumes all responsibility and liability for compliance in all respects with such laws and regulations. User assumes all responsibility and liability for proper disposal and recycling of the EVM consistent with all applicable international, federal, state, and local requirements.

5. *Accuracy of Information:* To the extent TI provides information on the availability and function of EVMs, TI attempts to be as accurate as possible. However, TI does not warrant the accuracy of EVM descriptions, EVM availability or other information on its websites as accurate, complete, reliable, current, or error-free.

6. *Disclaimers:*
- 6.1 EXCEPT AS SET FORTH ABOVE, EVMS AND ANY WRITTEN DESIGN MATERIALS PROVIDED WITH THE EVM (AND THE DESIGN OF THE EVM ITSELF) ARE PROVIDED "AS IS" AND "WITH ALL FAULTS." TI DISCLAIMS ALL OTHER WARRANTIES, EXPRESS OR IMPLIED, REGARDING SUCH ITEMS, INCLUDING BUT NOT LIMITED TO ANY IMPLIED WARRANTIES OF MERCHANTABILITY OR FITNESS FOR A PARTICULAR PURPOSE OR NON-INFRINGEMENT OF ANY THIRD PARTY PATENTS, COPYRIGHTS, TRADE SECRETS OR OTHER INTELLECTUAL PROPERTY RIGHTS.
- 6.2 EXCEPT FOR THE LIMITED RIGHT TO USE THE EVM SET FORTH HEREIN, NOTHING IN THESE TERMS AND CONDITIONS SHALL BE CONSTRUED AS GRANTING OR CONFERRING ANY RIGHTS BY LICENSE, PATENT, OR ANY OTHER INDUSTRIAL OR INTELLECTUAL PROPERTY RIGHT OF TI, ITS SUPPLIERS/LICENSORS OR ANY OTHER THIRD PARTY, TO USE THE EVM IN ANY FINISHED END-USER OR READY-TO-USE FINAL PRODUCT, OR FOR ANY INVENTION, DISCOVERY OR IMPROVEMENT MADE, CONCEIVED OR ACQUIRED PRIOR TO OR AFTER DELIVERY OF THE EVM.
7. *USER'S INDEMNITY OBLIGATIONS AND REPRESENTATIONS.* USER WILL DEFEND, INDEMNIFY AND HOLD TI, ITS LICENSORS AND THEIR REPRESENTATIVES HARMLESS FROM AND AGAINST ANY AND ALL CLAIMS, DAMAGES, LOSSES, EXPENSES, COSTS AND LIABILITIES (COLLECTIVELY, "CLAIMS") ARISING OUT OF OR IN CONNECTION WITH ANY HANDLING OR USE OF THE EVM THAT IS NOT IN ACCORDANCE WITH THESE TERMS AND CONDITIONS. THIS OBLIGATION SHALL APPLY WHETHER CLAIMS ARISE UNDER STATUTE, REGULATION, OR THE LAW OF TORT, CONTRACT OR ANY OTHER LEGAL THEORY, AND EVEN IF THE EVM FAILS TO PERFORM AS DESCRIBED OR EXPECTED.
8. *Limitations on Damages and Liability:*
- 8.1 *General Limitations.* IN NO EVENT SHALL TI BE LIABLE FOR ANY SPECIAL, COLLATERAL, INDIRECT, PUNITIVE, INCIDENTAL, CONSEQUENTIAL, OR EXEMPLARY DAMAGES IN CONNECTION WITH OR ARISING OUT OF THESE TERMS AND CONDITIONS OR THE USE OF THE EVMS PROVIDED HEREUNDER, REGARDLESS OF WHETHER TI HAS BEEN ADVISED OF THE POSSIBILITY OF SUCH DAMAGES. EXCLUDED DAMAGES INCLUDE, BUT ARE NOT LIMITED TO, COST OF REMOVAL OR REINSTALLATION, ANCILLARY COSTS TO THE PROCUREMENT OF SUBSTITUTE GOODS OR SERVICES, RETESTING, OUTSIDE COMPUTER TIME, LABOR COSTS, LOSS OF GOODWILL, LOSS OF PROFITS, LOSS OF SAVINGS, LOSS OF USE, LOSS OF DATA, OR BUSINESS INTERRUPTION. NO CLAIM, SUIT OR ACTION SHALL BE BROUGHT AGAINST TI MORE THAN ONE YEAR AFTER THE RELATED CAUSE OF ACTION HAS OCCURRED.
- 8.2 *Specific Limitations.* IN NO EVENT SHALL TI'S AGGREGATE LIABILITY FROM ANY WARRANTY OR OTHER OBLIGATION ARISING OUT OF OR IN CONNECTION WITH THESE TERMS AND CONDITIONS, OR ANY USE OF ANY TI EVM PROVIDED HEREUNDER, EXCEED THE TOTAL AMOUNT PAID TO TI FOR THE PARTICULAR UNITS SOLD UNDER THESE TERMS AND CONDITIONS WITH RESPECT TO WHICH LOSSES OR DAMAGES ARE CLAIMED. THE EXISTENCE OF MORE THAN ONE CLAIM AGAINST THE PARTICULAR UNITS SOLD TO USER UNDER THESE TERMS AND CONDITIONS SHALL NOT ENLARGE OR EXTEND THIS LIMIT.
9. *Return Policy.* Except as otherwise provided, TI does not offer any refunds, returns, or exchanges. Furthermore, no return of EVM(s) will be accepted if the package has been opened and no return of the EVM(s) will be accepted if they are damaged or otherwise not in a resalable condition. If User feels it has been incorrectly charged for the EVM(s) it ordered or that delivery violates the applicable order, User should contact TI. All refunds will be made in full within thirty (30) working days from the return of the components(s), excluding any postage or packaging costs.
10. *Governing Law:* These terms and conditions shall be governed by and interpreted in accordance with the laws of the State of Texas, without reference to conflict-of-laws principles. User agrees that non-exclusive jurisdiction for any dispute arising out of or relating to these terms and conditions lies within courts located in the State of Texas and consents to venue in Dallas County, Texas. Notwithstanding the foregoing, any judgment may be enforced in any United States or foreign court, and TI may seek injunctive relief in any United States or foreign court.

Mailing Address: Texas Instruments, Post Office Box 655303, Dallas, Texas 75265
Copyright © 2014, Texas Instruments Incorporated

IMPORTANT NOTICE

Texas Instruments Incorporated and its subsidiaries (TI) reserve the right to make corrections, enhancements, improvements and other changes to its semiconductor products and services per JESD46, latest issue, and to discontinue any product or service per JESD48, latest issue. Buyers should obtain the latest relevant information before placing orders and should verify that such information is current and complete. All semiconductor products (also referred to herein as "components") are sold subject to TI's terms and conditions of sale supplied at the time of order acknowledgment.

TI warrants performance of its components to the specifications applicable at the time of sale, in accordance with the warranty in TI's terms and conditions of sale of semiconductor products. Testing and other quality control techniques are used to the extent TI deems necessary to support this warranty. Except where mandated by applicable law, testing of all parameters of each component is not necessarily performed.

TI assumes no liability for applications assistance or the design of Buyers' products. Buyers are responsible for their products and applications using TI components. To minimize the risks associated with Buyers' products and applications, Buyers should provide adequate design and operating safeguards.

TI does not warrant or represent that any license, either express or implied, is granted under any patent right, copyright, mask work right, or other intellectual property right relating to any combination, machine, or process in which TI components or services are used. Information published by TI regarding third-party products or services does not constitute a license to use such products or services or a warranty or endorsement thereof. Use of such information may require a license from a third party under the patents or other intellectual property of the third party, or a license from TI under the patents or other intellectual property of TI.

Reproduction of significant portions of TI information in TI data books or data sheets is permissible only if reproduction is without alteration and is accompanied by all associated warranties, conditions, limitations, and notices. TI is not responsible or liable for such altered documentation. Information of third parties may be subject to additional restrictions.

Resale of TI components or services with statements different from or beyond the parameters stated by TI for that component or service voids all express and any implied warranties for the associated TI component or service and is an unfair and deceptive business practice. TI is not responsible or liable for any such statements.

Buyer acknowledges and agrees that it is solely responsible for compliance with all legal, regulatory and safety-related requirements concerning its products, and any use of TI components in its applications, notwithstanding any applications-related information or support that may be provided by TI. Buyer represents and agrees that it has all the necessary expertise to create and implement safeguards which anticipate dangerous consequences of failures, monitor failures and their consequences, lessen the likelihood of failures that might cause harm and take appropriate remedial actions. Buyer will fully indemnify TI and its representatives against any damages arising out of the use of any TI components in safety-critical applications.

In some cases, TI components may be promoted specifically to facilitate safety-related applications. With such components, TI's goal is to help enable customers to design and create their own end-product solutions that meet applicable functional safety standards and requirements. Nonetheless, such components are subject to these terms.

No TI components are authorized for use in FDA Class III (or similar life-critical medical equipment) unless authorized officers of the parties have executed a special agreement specifically governing such use.

Only those TI components which TI has specifically designated as military grade or "enhanced plastic" are designed and intended for use in military/aerospace applications or environments. Buyer acknowledges and agrees that any military or aerospace use of TI components which have **not** been so designated is solely at the Buyer's risk, and that Buyer is solely responsible for compliance with all legal and regulatory requirements in connection with such use.

TI has specifically designated certain components as meeting ISO/TS16949 requirements, mainly for automotive use. In any case of use of non-designated products, TI will not be responsible for any failure to meet ISO/TS16949.

Products

Audio	www.ti.com/audio
Amplifiers	amplifier.ti.com
Data Converters	dataconverter.ti.com
DLP® Products	www.dlp.com
DSP	dsp.ti.com
Clocks and Timers	www.ti.com/clocks
Interface	interface.ti.com
Logic	logic.ti.com
Power Mgmt	power.ti.com
Microcontrollers	microcontroller.ti.com
RFID	www.ti-rfid.com
OMAP Applications Processors	www.ti.com/omap
Wireless Connectivity	www.ti.com/wirelessconnectivity

Applications

Automotive and Transportation	www.ti.com/automotive
Communications and Telecom	www.ti.com/communications
Computers and Peripherals	www.ti.com/computers
Consumer Electronics	www.ti.com/consumer-apps
Energy and Lighting	www.ti.com/energy
Industrial	www.ti.com/industrial
Medical	www.ti.com/medical
Security	www.ti.com/security
Space, Avionics and Defense	www.ti.com/space-avionics-defense
Video and Imaging	www.ti.com/video

TI E2E Community

e2e.ti.com