

The invisible hand for more convenient world

**Autonics** sensors & controllers

**Autonics**  
Sensors & Controllers

**Autonics** Control Switches / Buzzers / Sockets

# Control Switches Buzzers Sockets



Autonics Control Switches,  
**Feel the difference  
in your fingertips**

# Control switches

## Push button switches



## Push button switches(Illuminated)



## Selector switches

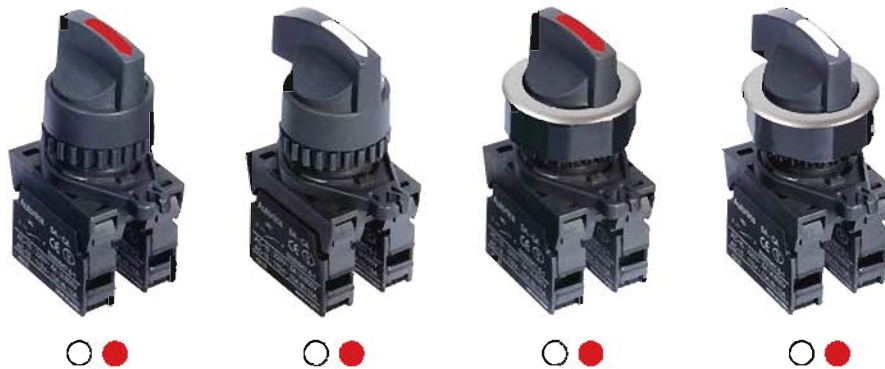

## Double push button switches



## Start push button switches



## Emergency switches



# Buzzers / Sockets / Digital switches

## ■ Pilot lamps



## ■ Piezo buzzers



## ■ Magnetic buzzers



## ■ Sockets

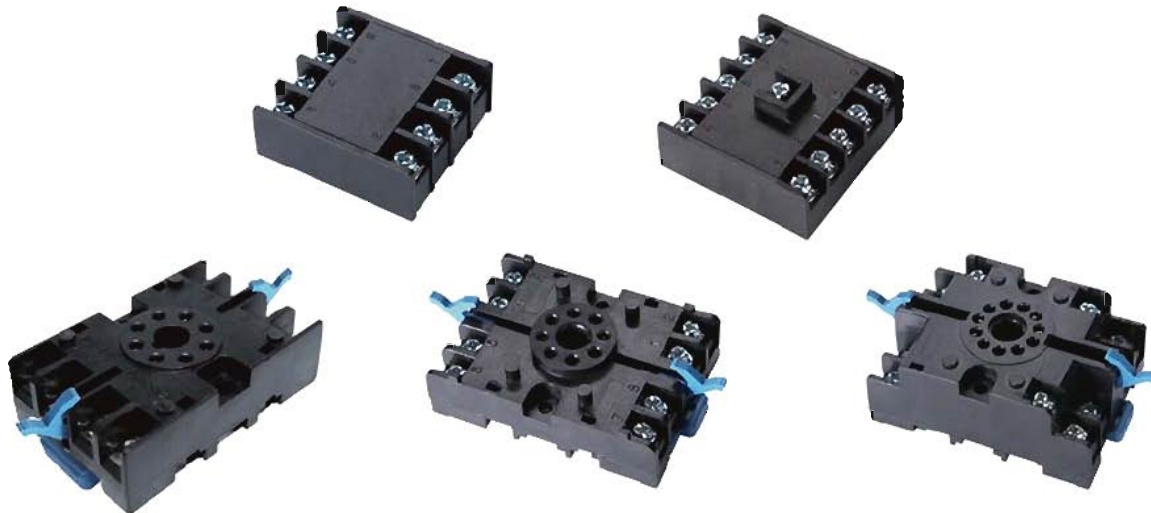

## ■ Digital switches





## Control switches

	Non-Flush	Flush	Page		
Push button switches	Ø22/25		06		
	Ø30	Ø30			
Push button switches(Illuminated)	Ø22/25		08		
		Ø30			
Selector switches	Short lever	Ø22/25	10		
		Ø30			
	Long lever	Ø22/25			
		Ø30			
Double push button switches	Ø22/25		12		
Start push button switches	Head D40	Ø22/25	13		
Emergency switches	Head D30L	Ø22/25	14		
	Head D30S	Ø22/25			
	Head D40	Ø22/25			
	Head D60	Ø22/25			
Emergency switches(Illuminated)	Head D40	Ø22/25	16		
	DOME TYPE	HORN TYPE	FLAT TYPE	FLAT TYPE (Non-Flush)	Page
Pilot lamps	Ø22/25	Ø22/25	Ø22/25		17
				Ø30	
Accessory	Switches contact block, Flush mount adaptor, Switch boxes, Emergency switch nameplates, Emergency switch protective shroud, Waterproof cap, Locking ring wrench				20

## Buzzers

	Non-Flush	Page
Magnetic buzzers	Ø22/25	24
Piezo buzzers	Ø22/25	24
	Ø30	

## Sockets

PG-08	PG-11	PS-08	PS-11	PS-M8	25
-------	-------	-------	-------	-------	----

## Digital switches

AD105-I,B	AD604-I,B	AD605-I,B	29
-----------	-----------	-----------	----



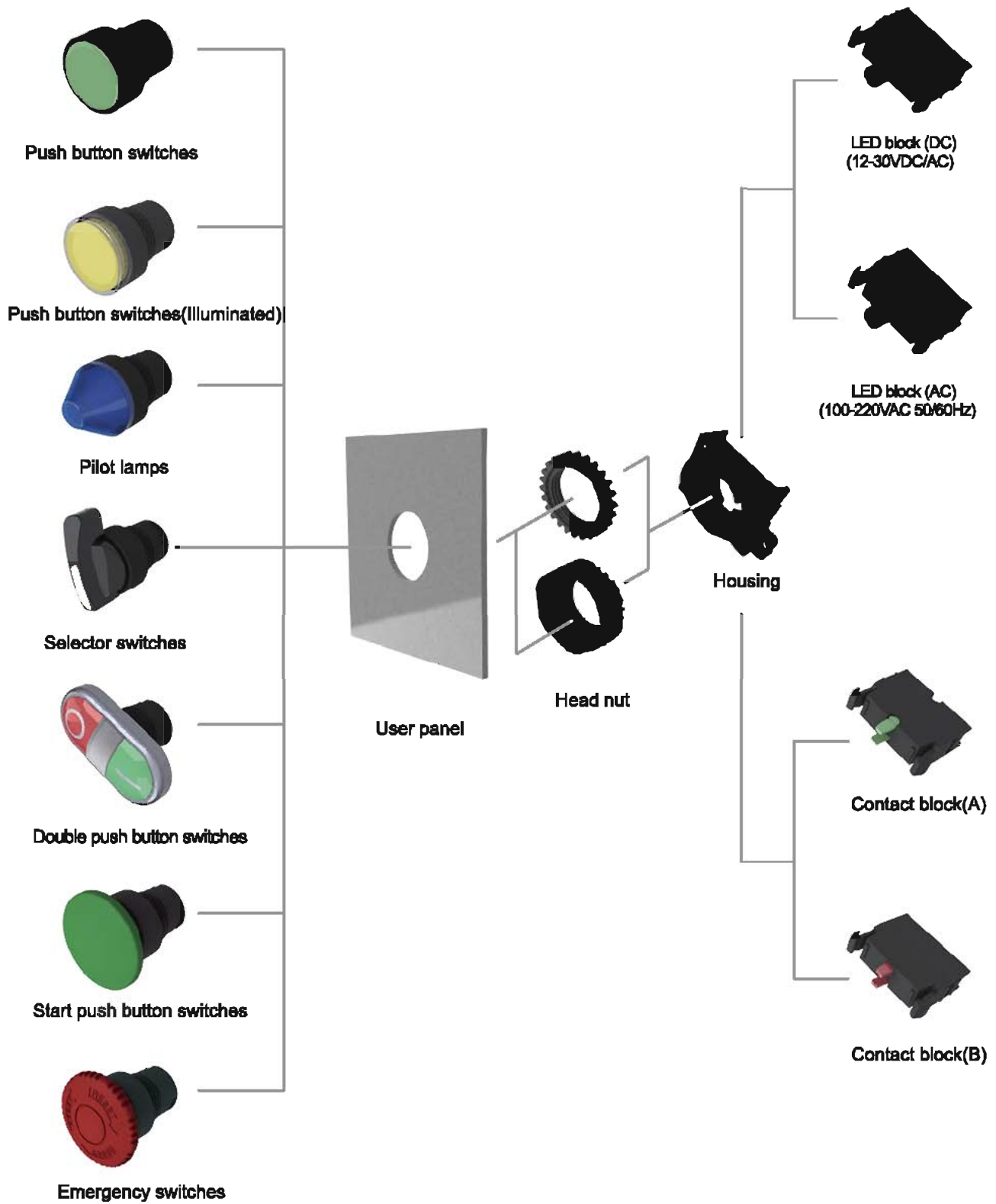

## Control switches



## Control switches series

Items	Push button switches			Push button switches(Illuminated)		Double push button switches	Start push button switches
	Non-Flush Ø22 / 25	Non-Flush Ø30	Flush Ø30	Non-Flush Ø22 / 25	Flush Ø30	Non-Flush Ø22 / 25	Non-Flush Ø22 / 25
Mounting hole dimension	Ø22 / 25	Ø30	Ø30	Ø22 / 25	Ø30	Ø22 / 25	Ø22 / 25
Model	S2PR - P1	S3PR - P1	S3PF - P1	S2PR - P3	S3PF - P3	S2TR - P3	S2BR - P1
Appearance							
Page	06	07	07	08	08	12	13
Items	Selector switches, Non-Flush		Selector switches, Non-Flush				
	Short lever Ø22 / 25	Long lever Ø22 / 25	Short lever Ø30	Long lever Ø30			
Mounting hole dimension	Ø22 / 25	Ø22 / 25	Ø30	Ø30			
Model	S2SR - S3,5,7	S2SR - S4,6,8	S3SF - S3,5,7	S3SF - S4,6,8			
Appearance							
Page	10	10	11	11			
Items	Ø30 Emergency switches		Ø40 Emergency switches		Ø60 Emergency switches		
	Large Head Ø22 / 25	Small Head Ø22 / 25	Non-Illuminated Ø22 / 25	Illuminated Ø22 / 25	Non-Illuminated Ø22 / 25		
Mounting hole dimension	Ø22 / 25	Ø22 / 25	Ø22 / 25	Ø22 / 25	Ø22 / 25		
Model	S2ER - E1	S2ER - E2	S2ER - E3	S2ER - E4	S2ER - E5		
Appearance							
Page	14	15	15	18	16		
Items	Dome type / Horn type / Flat type pilot lamps						
	Dome type, Non-Flush Ø22 / 25	Horn type, Non-Flush Ø22 / 25	Flat type, Non-Flush Ø22 / 25	Flat type, Flush Ø30			
Mounting hole dimension	Ø22 / 25	Ø22 / 25	Ø22 / 25	Ø30			
Model	L2RR - L1	L2RR - L2	L2RR - L3	L3RF - L3			
Appearance							
Page	17	18	18	18			

## Specifications

Mechanical characteristics	Actuating travel	5.5mm (0 ~ -0.5)	
	Actuating force	4.9N (0.5Kgf) (at 1 contact)	
	Shock	Shock resistance	500m/s <sup>2</sup> (50G) In each of x,y,z directions for 3 times
		Mechanical malfunction	100m/s <sup>2</sup> (10G) In each of x,y,z directions for 3 times
	Vibration	Vibration resistance	1.5mm amplitude at frequency of 10-55Hz(for 1 minute) in each of x,y,z directions for 2 hours
Mechanical malfunction		1.5mm amplitude at frequency of 10-55Hz(for 1 minute) In each of x,y,z directions for 10 minutes	
	Mechanical life time	Min. 1000 thousand (20 times/min)	
Electrical characteristics	Rated voltage/current	110VAC/10A, 220VAC/5A	
	Dielectric strength	2000VAC 50/60Hz For 1 minute	
	Insulation resistance	Min.100MΩ (at 500VDC)	
	Contact resistance	Max.20mΩ (Initial value)	
	Electric life cycle	Min. 1000 thousand (20 times/min)	
LED block	Rated voltage	DC type : 12-30VAC/DC, AC type : 100-220VAC	
	Power consumption	Max. 20mA	
	Ambient temperature	-15 ~ 55°C (at non-freezing status)	
Environmental characteristics	Ambient humidity	35 ~ 85%RH	
	Storage temperature	-25 ~ 85°C (at non-freezing status)	
	Protection degree	IP52 (IP 50 for Double push button switch)	
Approval	   (Emergency switches is  process of certification)		



# Push button switches

<b>S</b>	<b>2</b>	<b>PR</b>	<b>-</b>	<b>P1</b>	<b>R</b>	<b>A</b>	<b>D</b>
①	②	③		④	⑤	⑥	⑦

Classification	Ordering Information							Description	
	①	②	③	-	④	⑤	⑥		⑦
Model	S							Control Switches	
Dimension	2							Ø22/25	
	3							Ø30	
Appearance			PR					Push button switches (Non-Flush)	
			PF					Push button switches (Flush)	
Operation					P1			Auto spring return (Non-Illuminated)	
					P3			Auto spring return (Illuminated)	
Color						R		RED	
						B		BLUE	
						G		GREEN	
						Y		YELLOW	
						K		BLACK (Available for Non-Illuminated type only)	
						W		WHITE (Available for Illuminated type only)	
Contact / LED block							A	A (Normal open) 110VAC/10A, 220VAC/5A	
							B	B (Normal close) 110VAC/10A, 220VAC/5A	
							D	LED 12-30VDC/AC	
							L	LED 100-220VAC	

## Ø22/25 Push button switches(Non-Flush)



Model	Contacts	
	A contact	B contact
S2PR - P1□A	1EA	
" - " □2A	2EA	
" - " □3A	3EA	
" - " □B		1EA
" - " □2B		2EA
" - " □3B		3EA
" - " □AB	1EA	1EA
" - " □2AB	2EA	1EA
" - " □A2B	1EA	2EA

※ Represents colors □ : R, B, G, Y, K



- ⊕ Easy assembly and removal by one touch
- ⊕ Mounting hole layout : Ø22.5 / 25.5mm
- ⊕ Waterproof cap available ( SA-WP )

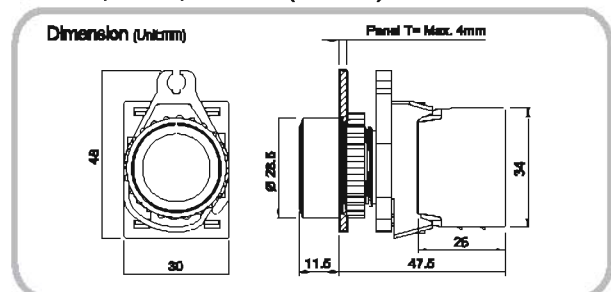



● Ø30 Push button switches (Non-Flush)

launching soon



Model	Contacts	
	A contact	B contact
S3PR - P1□A	1EA	
" - " □2A	2EA	
" - " □3A	3EA	
" - " □B		1EA
" - " □2B		2EA
" - " □3B		3EA
" - " □AB	1EA	1EA
" - " □2AB	2EA	1EA
" - " □A2B	1EA	2EA

\* Represents colors □ : R, B, G, Y, K  
● ● ● ● ●

- Simple and elegant design
- Mounting hole layout : Ø30.5mm

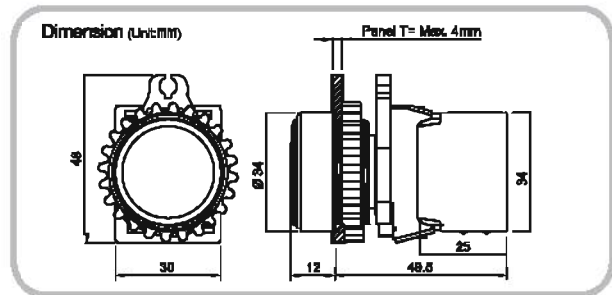

● Ø30 Push button switches (Flush)

launching soon



Model	Contacts	
	A contact	B contact
S3PF - P1□A	1EA	
" - " □2A	2EA	
" - " □3A	3EA	
" - " □B		1EA
" - " □2B		2EA
" - " □3B		3EA
" - " □AB	1EA	1EA
" - " □2AB	2EA	1EA
" - " □A2B	1EA	2EA

\* Represents colors □ : R, B, G, Y, K  
● ● ● ● ●

- Realizing 2.5mm non-flushed panel thickness
- Mounting hole layout : Ø30.5mm

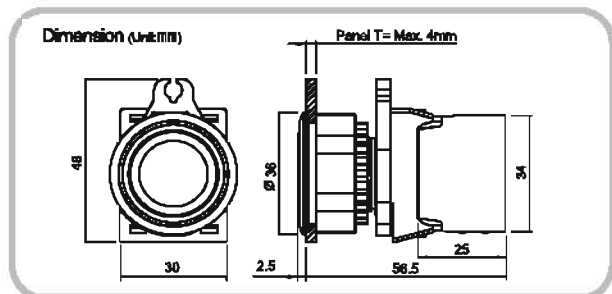

Push button switches

Push button switches (Illuminated)

Selector switches

Double push button switches

Start push button switches

Emergency switches

Emergency switches (Illuminated)

Pilot lamps

Accessory

Magnetic buzzers

Piezo buzzers

Sockets

Digital switches





# Push button switches (Illuminated)

## ● Ø22/25 Push button switches (Illuminated / Non-Flush)



Model	Contacts		LED	
	A contact	B contact	DC type	AC type
S2PR - P3□AD	1EA		1EA	
# - # □2AD	2EA		1EA	
# - # □BD		1EA	1EA	
# - # □2BD		2EA	1EA	
# - # □ABD	1EA	1EA	1EA	
# - # □AL	1EA			1EA
# - # □2AL	2EA			1EA
# - # □BL		1EA		1EA
# - # □2BL		2EA		1EA
# - # □ABL	1EA	1EA		1EA

※ Represents colors □ : R, B, G, Y, W  
● ● ● ● ● ●

- Simple and elegant design
- Mounting hole layout : Ø22.5 / 25.5mm
- Mounting hole layout (SA - WL)

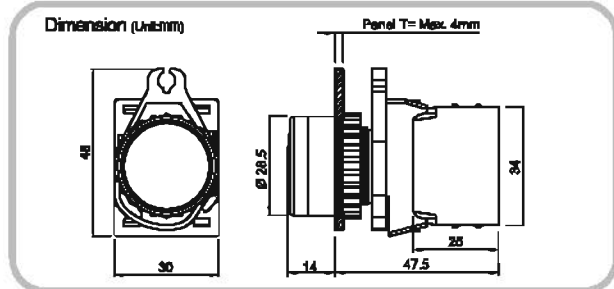

## ● Ø30 Push button switches (Illuminated / Flush)

launching soon



Model	Contacts		LED	
	A contact	B contact	DC type	AC type
S3PF - P3□AD	1EA		1EA	
# - # □2AD	2EA		1EA	
# - # □BD		1EA	1EA	
# - # □2BD		2EA	1EA	
# - # □ABD	1EA	1EA	1EA	
# - # □AL	1EA			1EA
# - # □2AL	2EA			1EA
# - # □BL		1EA		1EA
# - # □2BL		2EA		1EA
# - # □ABL	1EA	1EA		1EA

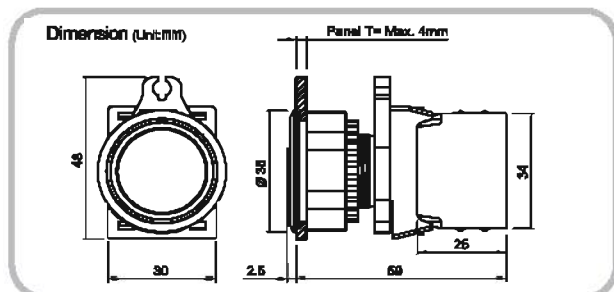

※ Represents colors □ : R, B, G, Y, W  
● ● ● ● ● ●

- Realizing 2.5mm flushed panel thickness
- Mounting hole layout : Ø30.5mm





**S**   **2**   **SR**   -   **S7**   **W**   **A**  
 ①   ②   ③   -   ④   ⑤   ⑥

Classification	Ordering Information						Description
	①	②	③	-	④	⑤	
Model	S						Control Switches
Dimension	2						Ø22/25
	3						Ø30
Appearance			SR				Selector Switches (Non-Flush)
			SF				Selector Switches (Flush)
Operation					S3		2 Positions maintained (Short lever)
					S4		2 Positions maintained (Long lever)
					S5		3 Positions Both auto spring return (Short lever)
					S6		3 Positions Both auto spring return (Long lever)
					S7		3 Positions Both maintained (Short lever)
					S8		3 Positions Both maintained (Long lever)
Color						R	RED
						W	WHITE
Contact						A	A (Normal Open) 110VAC/10A, 220VAC/5A 
						B	B (Normal Close) 110VAC/10A, 220VAC/5A 

Push button switches

Push button switches (Illuminated)

Selector switches

Double push button switches

Start push button switches

Emergency switches

Emergency switches (Illuminated)

Pilot lamps

Accessory

Magnetic buzzers

Piezo buzzers

Sockets

Digital switches

<< Operation description >>

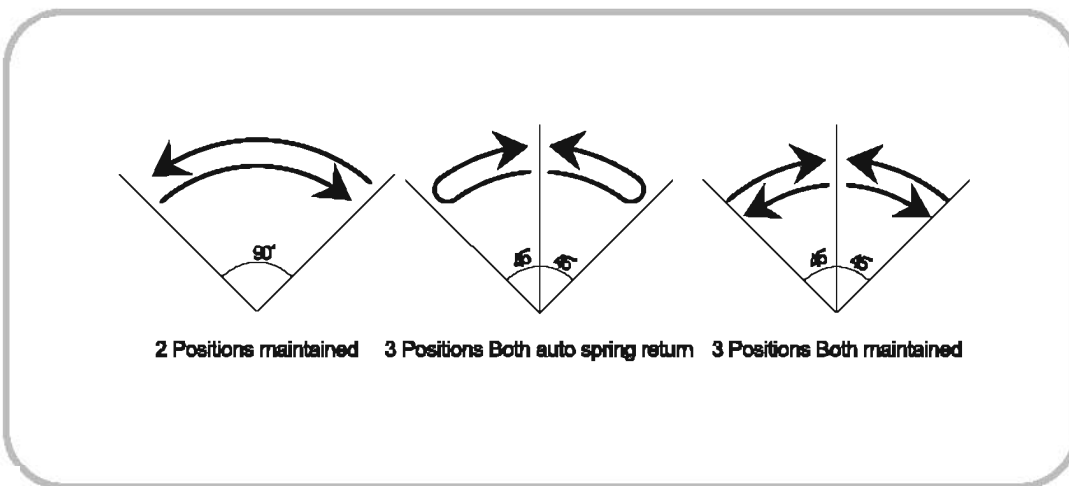



**Ø22/25 Short lever selector switches (Non-Flush)**



	Model		Contacts
	A contact	B contact	
2 Positions maintained	S2SR - S3□A	1EA	2EA
	# - # □2A	2EA	
	# - # □B	1EA	
	# - # □2B	2EA	
	# - # □AB	1EA 1EA	
3 Positions both auto spring return	S2SR - S5□2A	2EA	2EA
	# - # □3A	3EA	
	# - # □2B	2EA	
	# - # □3B	3EA	
	# - # □AB	1EA 1EA	
3 Positions both auto spring return	S2SR - S7□2A	2EA	2EA
	# - # □3A	3EA	
	# - # □2B	2EA	
	# - # □3B	3EA	
	# - # □AB	1EA 1EA	
3 Positions both maintained	S2SR - S5□2A	2EA	2EA
	# - # □3A	3EA	
	# - # □2B	2EA	
	# - # □3B	3EA	
	# - # □AB	1EA 1EA	
3 Positions both maintained	S2SR - S7□2A	2EA	2EA
	# - # □3A	3EA	
	# - # □2B	2EA	
	# - # □3B	3EA	
	# - # □AB	1EA 1EA	

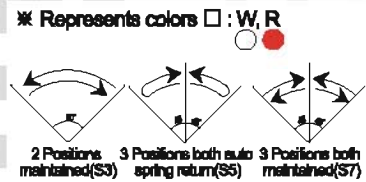

- Smooth and Swift switch operation
- Mounting hole layout : Ø22.5 / 25.5mm

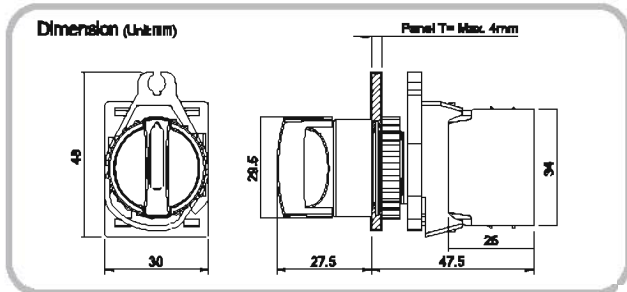

**Ø22/25 Long lever selector switches (Non-Flush)**



	Model		Contacts
	A contact	B contact	
2 Positions maintained	S2SR - S4□A	1EA	2EA
	# - # □2A	2EA	
	# - # □B	1EA	
	# - # □2B	2EA	
	# - # □AB	1EA 1EA	
3 Positions both maintained	S2SR - S6□2A	2EA	2EA
	# - # □3A	3EA	
	# - # □2B	2EA	
	# - # □3B	3EA	
	# - # □AB	1EA 1EA	
3 Positions both auto spring return	S2SR - S8□2A	2EA	2EA
	# - # □3A	3EA	
	# - # □2B	2EA	
	# - # □3B	3EA	
	# - # □AB	1EA 1EA	
3 Positions both auto spring return	S2SR - S6□2A	2EA	2EA
	# - # □3A	3EA	
	# - # □2B	2EA	
	# - # □3B	3EA	
	# - # □AB	1EA 1EA	
3 Positions both maintained	S2SR - S8□2A	2EA	2EA
	# - # □3A	3EA	
	# - # □2B	2EA	
	# - # □3B	3EA	
	# - # □AB	1EA 1EA	

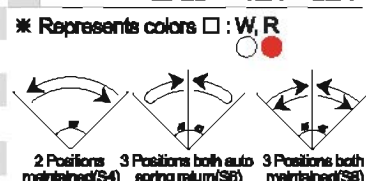

- Smooth and Swift switch operation
- Mounting hole layout : Ø22.5 / 25.5mm

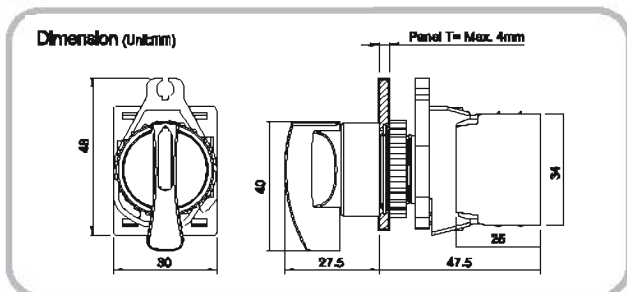



● Ø30 Short lever selector switches (Flush)



	Model	Contacts		Model	Contacts		
		A contact	B contact		A contact	B contact	
2 Positions maintained	S3SF - S3□A	1EA		3 Positions both maintained	S3SF - S7□2A	2EA	
	" - " □2A	2EA			" - " □3A	3EA	
	" - " □B		1EA		" - " □2B		2EA
	" - " □2B		2EA		" - " □3B		3EA
	" - " □AB	1EA	1EA		" - " □AB	1EA	1EA
3 Positions both auto spring return	S3SF - S5□2A	2EA		" - " □2AB	2EA	1EA	
	" - " □3A	3EA		" - " □A2B	1EA	2EA	
	" - " □2B		2EA	* Represents colors □ : W, R ○ : ●			
	" - " □3B		3EA				
	" - " □AB	1EA	1EA	2 Positions maintained (S3)	3 Positions both maintained (S5)	3 Positions both auto spring return (S7)	
	" - " □2AB	2EA	1EA				
	" - " □A2B	1EA	2EA				

- Simple and elegant design
- Mounting hole layout : Ø30.5mm

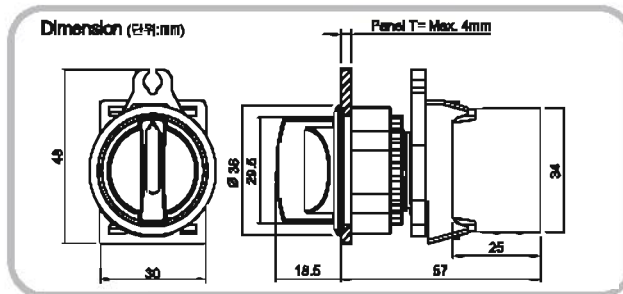

● Ø30 Long lever selector switches (Flush)



	Model	Contacts		Model	Contacts		
		A contact	B contact		A contact	B contact	
2 Positions maintained	S3SF - S4□A	1EA		3 Positions both maintained	S3SF - S8□2A	2EA	
	" - " □2A	2EA			" - " □3A	3EA	
	" - " □B		1EA		" - " □2B		2EA
	" - " □2B		2EA		" - " □3B		3EA
	" - " □AB	1EA	1EA		" - " □AB	1EA	1EA
3 Positions both auto spring return	S3SF - S6□2A	2EA		" - " □2AB	2EA	1EA	
	" - " □3A	3EA		" - " □A2B	1EA	2EA	
	" - " □2B		2EA	* Represents colors □ : W, R ○ : ●			
	" - " □3B		3EA				
	" - " □AB	1EA	1EA	2 Positions maintained (S4)	3 Positions both maintained (S8)	3 Positions both auto spring return (S8)	
	" - " □2AB	2EA	1EA				
	" - " □A2B	1EA	2EA				

- Simple and elegant design
- Mounting hole layout : Ø30.5mm

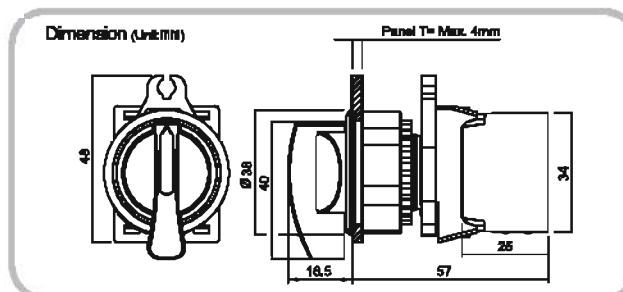

Push button switches

Push button switches (Illuminated)

Selector switches

Double push button switches

Start push button switches

Emergency switches

Emergency switches (Illuminated)

Pilot lamps

Accessory

Magnetic buzzers

Piezo buzzers

Sockets

Digital switches





# Double push button switches

<b>S</b>	<b>2</b>	<b>TR</b>	-	<b>P3</b>	<b>W</b>	<b>AB</b>	<b>D</b>
①	②	③		④	⑤	⑥	⑦

Classification	Ordering Information							Description		
	①	②	③	-	④	⑤	⑥		⑦	
Model	S								Control Switches	
Dimension	2								Ø22/25	
Appearance			TR						Double push button switches	
Operation					P3				Spring return type, Illuminated	
Color						W			WHITE	
Contact / LED Block							A		A (Normal Open) 110VAC/10A, 220VAC/5A	
							B		B (Normal Close) 110VAC/10A, 220VAC/5A	
								D	LED 12-30VDC/AC	
								L	LED 100-220VAC	

## Ø22/25 Double push button switches (Non-Flush)



Model	Contacts		LED	
	A contact	B contact	DC type	AC type
S2TR - P3WABD	1EA	1EA	1EA	
S2TR - P3WABL	1EA	1EA		1EA

- Soft streamlined design
- Mounting hole layout : Ø22.5 / 25.5mm

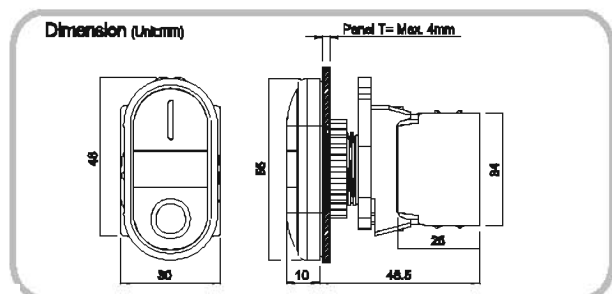



Push button switches

Push button switches (Illuminated)

Selector switches

Double push button switches

Start push button switches

Emergency switches

Emergency switches (Illuminated)

Pilot lamps

Accessory

Magnetic buzzers

Piezo buzzers

Sockets

Digital switches

**S** **2** **BR** - **P1** **G** **A**  
 ① ② ③ ④ ⑤ ⑥

Classification	Ordering Information						Description
	①	②	③	-	④	⑤	
Model	S						Control Switches
Dimension	2						Ø22/25
Appearance			BR				Start push button Switches
Operation					P1		Spring return type, Illuminated
Color						G R	GREEN RED
Contact						A	A (Normal Open) 110VAC/10A, 220VAC/5A
						B	B (Normal Close) 110VAC/10A, 220VAC/5A

● Ø Start push button switches (Non-Flush)

launching soon



Model	Contacts	
	A contact	B contact
S2BR - P1□A	1EA	
" - " □2A	2EA	
" - " □3A	3EA	
" - " □B		1EA
" - " □2B		2EA
" - " □3B		3EA
" - " □AB	1EA	1EA
" - " □2AB	2EA	1EA
" - " □A2B	1EA	2EA

\* Represents colors □ : R, G



- Mushroom-head shaped design
- Mounting hole layout : Ø22.5 / 25.5mm

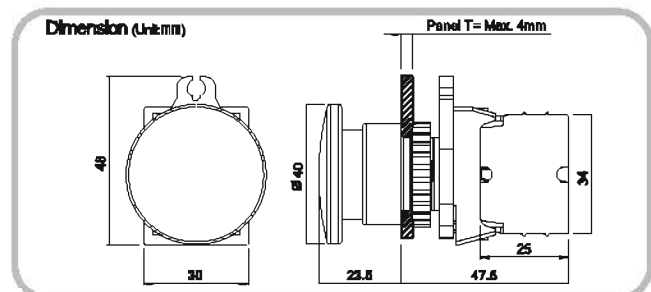



<b>S</b>	<b>2</b>	<b>ER</b>	-	<b>E1</b>	<b>R</b>	<b>B</b>	<b>D</b>
①	②	③		④	⑤	⑥	⑦

Classification	Ordering information							Description		
	①	②	③	-	④	⑤	⑥		⑦	
Model	S								Control switches	
Dimension	2								Ø22/25	
Appearance		ER							Emergency switches	
Operation				E1					Head Ø30(L) Push-Lock, Turn-Reset	
				E2					Head Ø30(S) Push-Lock, Turn-Reset	
				E3					Head Ø40 Push-Lock, Turn-Reset	
				E4					Head Ø40 Push-Lock, Turn-Reset(Illuminated)	
				E5					Head Ø60 Push-Lock, Turn-Reset	
Color					R				RED	
Contact / LED Block							A		A (Normal Open) 110VAC/10A, 220VAC/5A	
							B		B (Normal Close) 110VAC/10A, 220VAC/5A	
							D		LED 12-30VDC/AC	
							L		LED 100-220VAC	

## Ø22/25 Head D30L Emergency switches (Non-Flush)



Model	Contacts	
	A contact	B contact
S2ER - E1RA	1EA	
" - " 2A	2EA	
" - " 3A	3EA	
" - " B		1EA
" - " 2B		2EA
" - " 3B		3EA
" - " AB	1EA	1EA
" - " 2AB	2EA	1EA
" - " A2B	1EA	2EA

- ① Space-saving design
- ② Mounting hole layout : Ø22.5 / 25.5mm
- ③ PUSH LOCK & TURN RESET

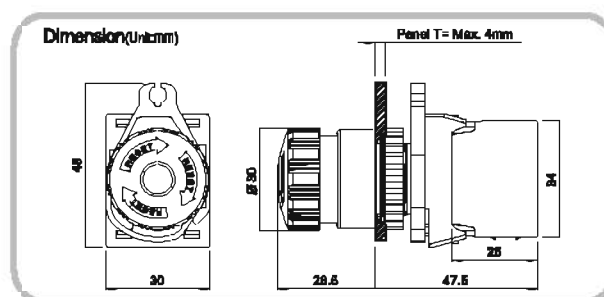



## Ø22/25 Head D30S Emergency switches (Non-Flush)



Model	Contacts	
	A contact	B contact
S2ER - E2RA	1EA	
# - # 2A	2EA	
# - # 3A	3EA	
# - # B		1EA
# - # 2B		2EA
# - # 3B		3EA
# - # AB	1EA	1EA
# - # 2AB	2EA	1EA
# - # A2B	1EA	2EA

- Space-saving design
- Mounting hole layout : Ø22.5 / 25.5mm
- PUSH LOCK & TURN RESET

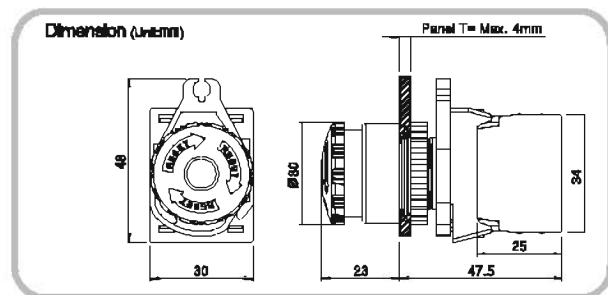

## Ø22/25 Head D40 Emergency switches (Non-Flush)



Model	Contacts	
	A contact	B contact
S2ER - E3RA	1EA	
# - # 2A	2EA	
# - # 3A	3EA	
# - # B		1EA
# - # 2B		2EA
# - # 3B		3EA
# - # AB	1EA	1EA
# - # 2AB	2EA	1EA
# - # A2B	1EA	2EA

- Simple and elegant design
- Mounting hole layout : Ø22.5 / 25.5mm
- PUSH LOCK & TURN RESET

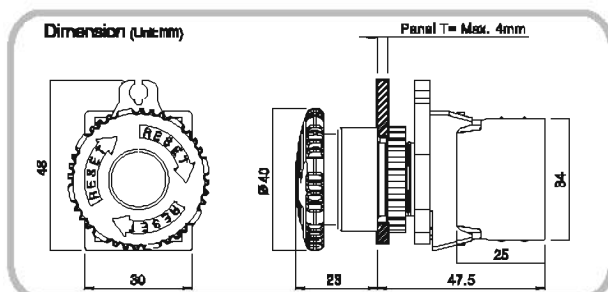

Push button switches

Push button switches (Illuminated)

Selector switches

Double push button switches

Start push button switches

Emergency switches

Emergency switches (Illuminated)

Pilot lamps

Accessory

Magnetic buzzers

Piezo buzzers

Sockets

Digital switches





## Ø22/25 Head D40 Emergency switches (Illuminated Non-Flush)



Model	Contacts		LED	
	A contact	B contact	DC type	AC type
S2ER - E4RAD	1EA		1EA	
" - " 2AD	2EA		1EA	
" - " BD		1EA	1EA	
" - " 2BD		2EA	1EA	
" - " ABD	1EA	1EA	1EA	
" - " AL	1EA			1EA
" - " 2AL	2EA			1EA
" - " BL		1EA		1EA
" - " 2BL		2EA		1EA
" - " ABL	1EA	1EA		1EA

- Improved visibility with high luminance LED
- Mounting hole layout : Ø22.5 / 25.5mm
- PUSH LOCK & TURN RESET

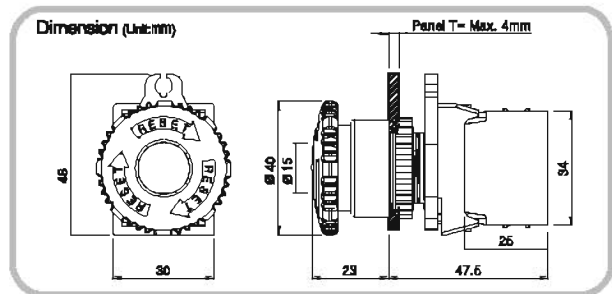

## Ø22/25 Head D60 Emergency Switches (Non-Flush)



Model	Contacts	
	A contact	B contact
S2ER - E5RA	1EA	
" - " 2A	2EA	
" - " 3A	3EA	
" - " B		1EA
" - " 2B		2EA
" - " 3B		3EA
" - " AB	1EA	1EA
" - " 2AB	2EA	1EA
" - " A2B	1EA	2EA

- Increasing user convenience with large size head (Ø60)
- Mounting hole layout : Ø22.5 / 25.5mm
- PUSH LOCK & TURN RESET

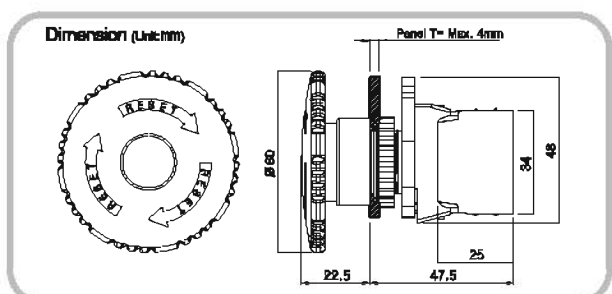



L 2 RR - L2 R D  
 ① ② ③ ④ ⑤ ⑥

Classification	Ordering Information						Description
	①	②	③	-	④	⑤ ⑥	
Model	L						Pilot lamps
Dimension		2 3					Ø22/25 Ø30
Appearance			RR RF				Round pilot lamps (Non-Flush) Round pilot lamps (Flush)
Head type					L1 L2 L3		DOME HEAD HORN HEAD FLAT HEAD
Color					R B G Y W		RED BLUE GREEN YELLOW WHITE
Contact						D L	LED 12-30VDC/AC LED 100-220VAC

Push button switches

Push button switches (Illuminated)

Selector switches

Double push button switches

Start push button switches

Emergency switches

Emergency switches (Illuminated)

Pilot lamps

Accessory

Magnetic buzzers

Piezo buzzers

Sockets

Digital switches

Ø22/25 DOME TYPE Pilot lamps (Non-Flush)



Model	LED	
	DC type	AC type
L2RR - L1□D	1EA	
* - * □L		1EA

\* Represents colors □ : R, B, G, Y, W

- Improved visibility with high luminance LED
- Mounting hole layout : Ø22.5 / 25.5mm

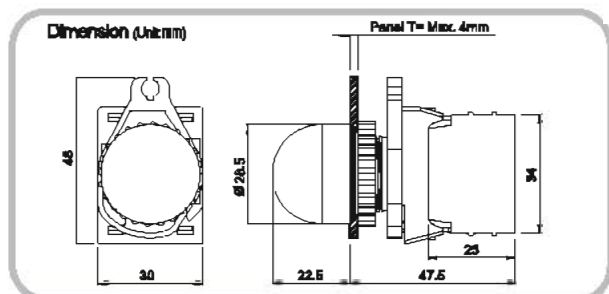



### Ø22/25 HORN TYPE Pilot lamps (Non-Flush)



Model	LED	
	DC type	AC type
L2RR - L2□D	1EA	
" - " □L	1EA	

※ Represents colors □: R, B, G, Y, W  
● ● ● ● ●

- Improved visibility with high luminance LED
- Mounting hole layout : Ø22.5 / 25.5mm

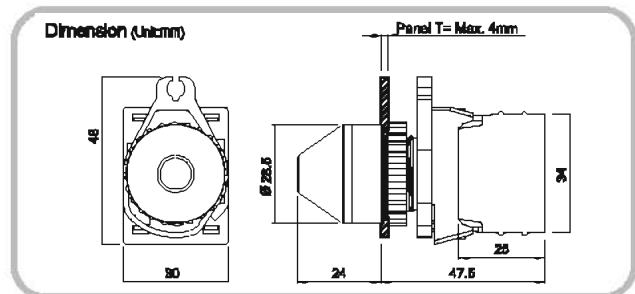

### Ø22/25 FLAT TYPE Pilot lamps (Non-Flush)



Model	LED	
	DC type	AC type
L2RR - L3□D	1EA	
" - " □L	1EA	

※ Represents colors □: R, B, G, Y, W  
● ● ● ● ●

- Simple and elegant design
- Mounting hole layout : Ø22.5 / 25.5mm

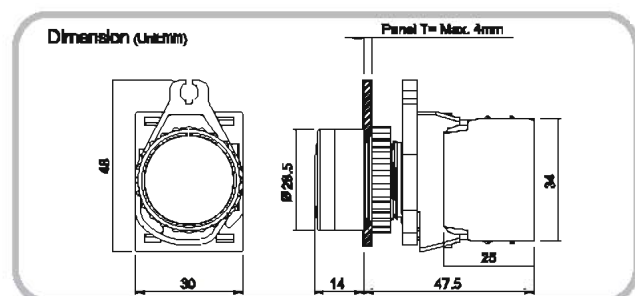



Ø30 FLAT TYPE Pilot lamps(Flush)

launching soon



Model	LED	
	DC type	AC type
L3RF - L3□D	1EA	
□ - □ □L		1EA

\* Represents colors □ : R, B, G, Y, W  
● ● ● ● ○

- Realizing 2.5mm non-flushed panel thickness
- Mounting hole layout : Ø30.5mm

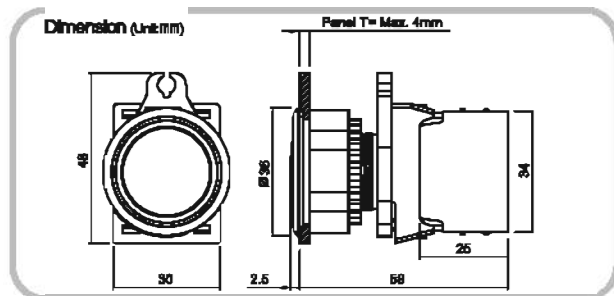

< Memo >

Push button switches

Push button switches (Illuminated)

Selector switches

Double push button switches

Start push button switches

Emergency switches

Emergency switches (Illuminated)

Pilot lamps

Accessory

Magnetic buzzers

Plezo buzzers

Sockets

Digital switches



● **Switches contact block**

SA ①	-	CA ②		
Classification	Ordering Information		Description	
Model	①	-	②	Switches Accessories
Contact /LED Block	SA			A Contact (Normal open)
			CA	B Contact (Normal close)
			LD	LED Block (12-30VDC/AC)
			LA	LED Block (100-220VAC 50/60HZ)

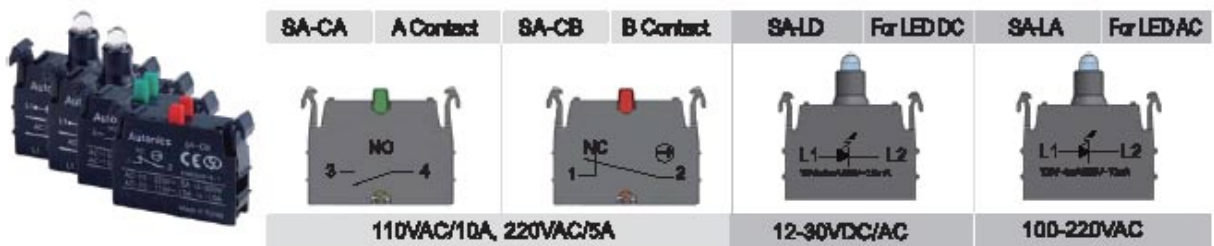

● **Switches boxes**

SA ①	-	SB ②	1 ③		
Classification	Ordering Information			Description	
Model	①	-	②	③	Switches accessories
Appearance			SB		Square boxes (Square type)
			TB		Triangle boxes
Number of holes				1	1 hole (Length : L=86mm)
				2	2 hole (Length : L=136mm)
				3	3 hole (Length : L=186mm)
				4	4 hole (Length : L=236mm)
				6	5 hole (Length : L=286mm)

\* The number of holes and box length can be customized

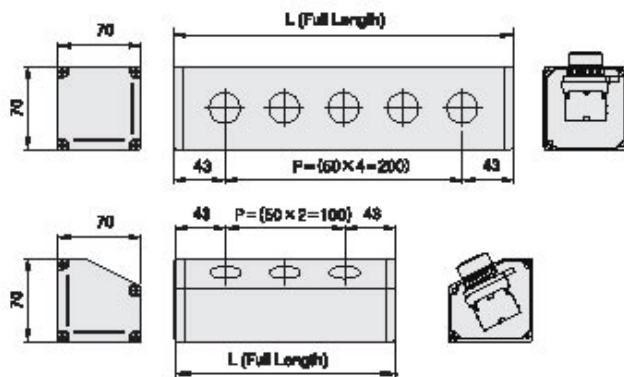

Dimensions (Unit : mm)  
Mounting hole layout  $\varnothing 22.5/25.5$



### Emergency switches nameplates

<b>SA</b> ①	-	<b>NS</b> ②	
Classification	Ordering Information		Description
Model	SA		Switches accessories
Appearance		NS	Nameplate small size
		NL	Nameplate large size



**Panel mounting hole layout**

It is recommended to leave the interval of 50 mm between each panel hole. In case of S2RE-E5R, leave the interval of 60mm or more.

(Unit : mm)

### Emergency switches protective shroud

<b>SA</b> ①	-	<b>EG</b> ②	<b>1</b> ③	
Classification	Ordering Information			Description
Model	SA			Switches accessories
Appearance		EG		Emergency switches protective shroud
Dimension			1	Ø22, SMALL
			2	Ø22, LARGE
			3	Ø25, LARGE

Dimension of small type

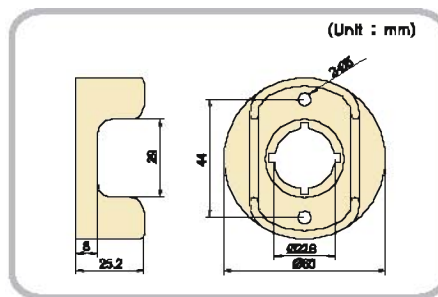

Dimension of large type

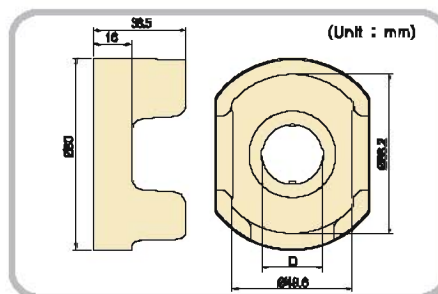

D part Dimension	
SA-EG2	Ø22.5
SA-EG3	Ø25.5

Push button switches

Push button switches (Illuminated)

Selector switches

Double push button switches

Start push button switches

Emergency switches

Emergency switches (Illuminated)

Pilot lamps

Accessory

Magnetic buzzers

Piezo buzzers

Sockets

Digital switches

**Water proof cap**

<b>SA</b> ①	-	<b>WP</b> ②		
Classification		Ordering Information		Description
Model	SA	-	②	
Appearance		WP	WL	
				Switch accessories
				For push button
				For illuminated push button

(Unit : mm)

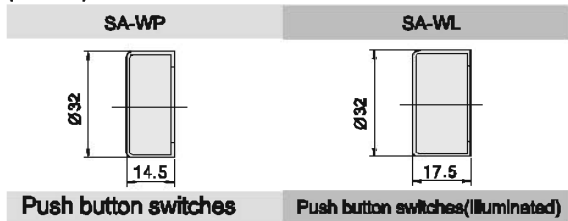

※ For Non-flush  $\varnothing 22/25$  Non-Flush switches

**Locking handle for switches**

<b>SA</b> ①	-	<b>LH</b> ②		
Classification		Ordering information		Description
Model	SA	-	②	
Appearance		LH		
				Switch accessories
				Locking ring wrench (Locking handle)

(Unit : mm)

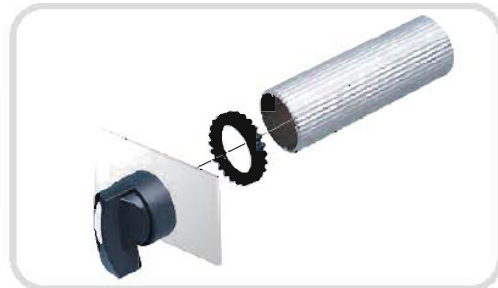
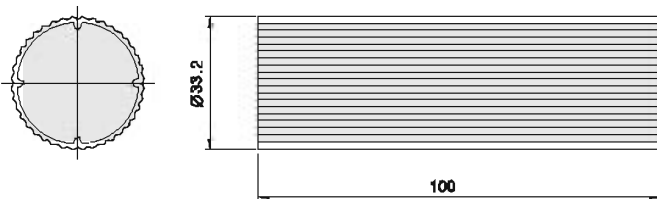

When mounting  $\varnothing 25$  panel hole,

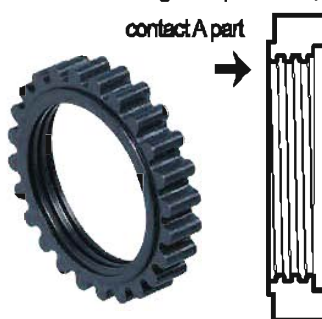

contact A part

When mounting  $\varnothing 22$  panel hole, contact B part

**● Guideline for mounting switch Nut**

Available for  $\varnothing 22/25$  Flush Push buttons. When Mounting  $\varnothing 25$  panel hole, contact A part with switch nut . When Mounting  $\varnothing 22$  panel hole, contact B part with switch nut



■ Buzzers

Classification	Magnetic buzzers	Piezo buzzers	
	Standard	Continuous sound	
Mounting hole	Ø22 / 25	Ø22 / 25	Ø30
Model	B2NB - B1	B2PB -B2, B3, B4	B3PB -B2, B3, B4
Appearance			
Page	24	24	24

■ Specifications

Model	B2NB - B1D	B2PB - B2,B3,B4	B3PB - B2,B3,B4
Rated voltage		12-24VDC	
Rated current	Max.60mA		Max.25mA
Sound level	Approx.75dB(1m) Approx.85dB(0.1m)		Approx.90dB(0.1m)
Sound type	Continuous / Intermittent sound		Continuous / Intermittent / Dual sound
Insulation resistance	Min. 50MΩ(at 500VDC)		Min. 100MΩ(at 500VDC)
Dielectric strength	1000VAC 50/60Hz For 1 minute		2000VAC 50/60Hz For 1 minute
Vibration resistance	1.5mm amplitude at frequency of 10~55Hz(for 1minute) in each of x,y,z directions for 2 hours		
Shock resistance	500m/s²(50G) In each of x,y,z directions for 3 times		
Ambient temperature	-15 ~ 55°C (at non-freezing status)		
Storage temperature	-25 ~ 65°C (at non-freezing status)		
Ambient humidity	35 ~ 85%RH		
Protection degree	IP30		
Material	Body	Nylon6	
	Cover	PC	
Unit weight	Approx.18g	Approx. 20g	Approx.25g

< Memo >

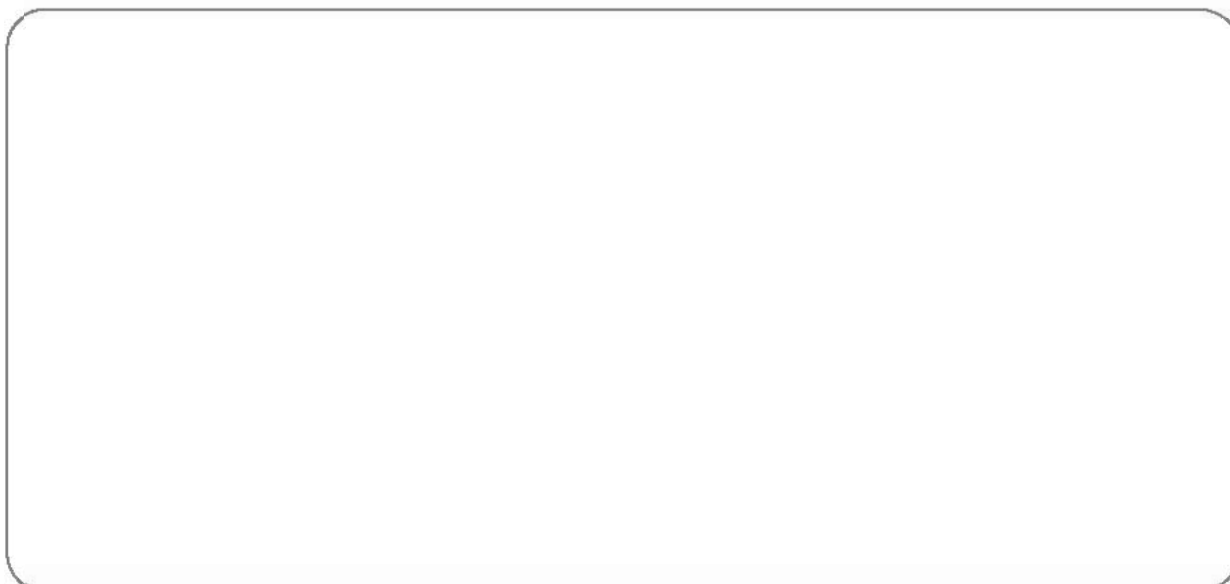

Push button switches

Push button switches (Illuminated)

Selector switches

Double push button switches

Start push button switches

Emergency switches

Emergency switches (Illuminated)

Pilot lamps

Accessory

Magnetic buzzers

Piezo buzzers

Sockets

Digital switches



# Buzzers

Classification	Ordering Information					Description
	①	②	③	-	④	
Model	B					Buzzers
Dimension	2					Ø22/25
	3					Ø30
Appearance			NB			Magnetic buzzers
			PB			Piezo buzzers
Sound				B1		Standard
				B2		Dual
				B3		Continuous
				B4		Intermittent
Power supply					D	12 - 24VDC

## ● Ø22/25 Magnetic buzzers(Non-Flush)



Model	B2NB - B1D
-------	------------

- Mounting hole layout : Ø22.5 / 25.5mm
- Selectable Continuous and Intermittent sound
- High visibility with LED

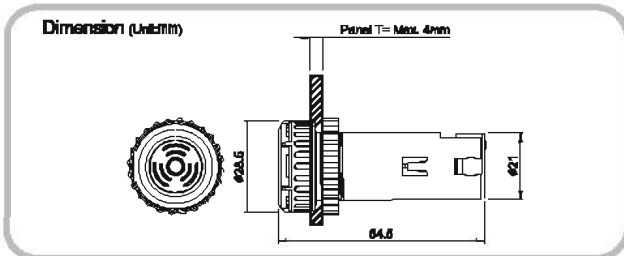

## ● Ø22/25 Piezo buzzers(Non-Flush)

launching soon



Model	Sound
B2PB - B2D	Dual
B2PB - B3D	Continuous Sound
B2PB - B4D	Intermittent Sound

- Optimal alarm solution with powerful sound level
- Mounting hole layout : Ø22.5 / 25.5mm
- Selectable continuous and Intermittent sound

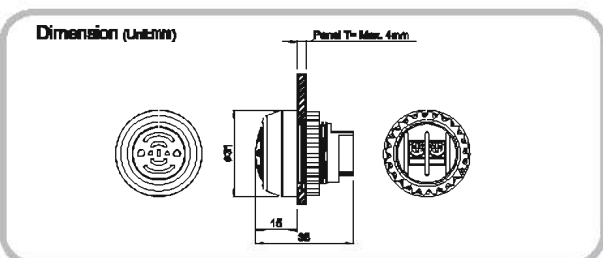

## ● Ø30 Piezo buzzers(Flush)

launching soon





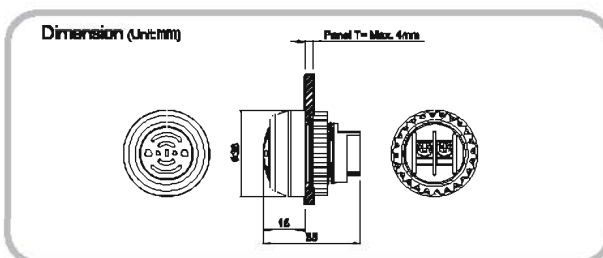

Model	Sound
B3PB - B2D	Dual
B3PB - B3D	Continuous Sound
B3PB - B4D	Intermittent Sound

- Optimal alarm solution with powerful sound level
- Mounting hole layout : Ø30.5mm
- Selectable continuous and Intermittent sound





## ■ Sockets

Classification	Sockets(Standard)		HOOK Sockets		
	8PIN	11PIN	8PIN	11PIN	8 PIN (MINI SIZE)
Model	PG - 08	PG - 11	PS - 08	PS-11	PS-M8
Appearance					
Page	26	27	27	28	29

Push Button Switches

Push Button Switches (Illuminated)

Selector Switches

DOUBLE Push Button Switches

Start Push Button Switches

Emergency Switches

Emergency Switches (Illuminated)

Pilot Lamps

Accessory



Magnetic Buzzers

Piezo Buzzers

Sockets

Digital Switches

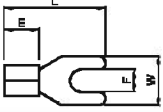
## ■ Specifications

Model	PG - 08	PG - 11	PS - 08	PS - 11	PS - M8
Rated voltage	250VAC				
Rated current	7A (Load resistance)				
Insulation resistance	Min. 100MΩ(at 500VDC)				
Dielectric strength	2000VAC 50/60Hz For 1 minute				
Vibration resistance	0.75mm amplitude at frequency of 10~55Hz(for 1minute) In each of x,y,z directions for 2 hours				
Shock resistance	980m/s(98G) In each of x,y,z directions for 3 times(In case of PS-M8, 300m/s (30G) In each of x,y,z directions for 3 times.)				
Ambient temperature	-10 ~ 55 °C (at non-freezing status)				
Storage temperature	-25 ~ 65 °C (at non-freezing status)				
Ambient humidity	35 ~ 85%RH				
Socket Torque	0.8N·m(In case of PS-M8, 0.75N·m~0.95N·m)				
Standard screw	M3.5				
Material	Body	PBT			
	Bolt	Steel plated with Ni			
	Nut	Steel plated with Ni			
	Terminal	PBIC plated with Ni			
Connection	E		4.5mm less than		
	F		Ø3.6 more than		
	W		6.8~7.1mm		
	L		15.7mm more than		
Approval					
Unit Weight	Approx. 37.5g	Approx. 47g	Approx. 62g	Approx. 85g	Approx. 43g

**P**   **G**   -   **08**  
 ①   ②   ③

Classification	Ordering information			Description
	①	②	③	
Model	P			Sockets
Appearance		G		Standard
Terminal			08	8 Pin
Appearance			11	11 Pin
Terminal		S		With HOOK
			08	8 Pin
			11	11 Pin
			M8	M8 Pin (Mini size-ATS Series only)

● Sockets(standard)



Model      PG-08

High heat resisting property and insulation resistance with PBT(UL94-V0 resin)-plated body  
 Improved electric capability and reliable connection with connection terminal made of copper alloy

Dimension (Unit:mm)

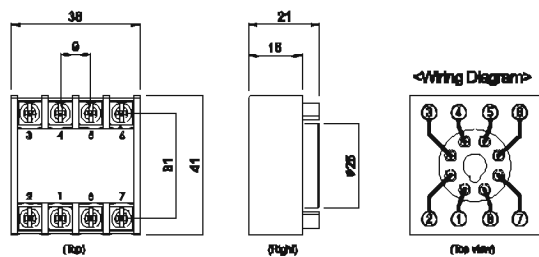

**Sockets(Standard)**



Model	PG-11
-------	-------

High heat resisting property and insulation resistance with PBT(UL94-V0 resin)-plated body.  
Improved electric capability and reliable connection with connection terminal made of copper alloy

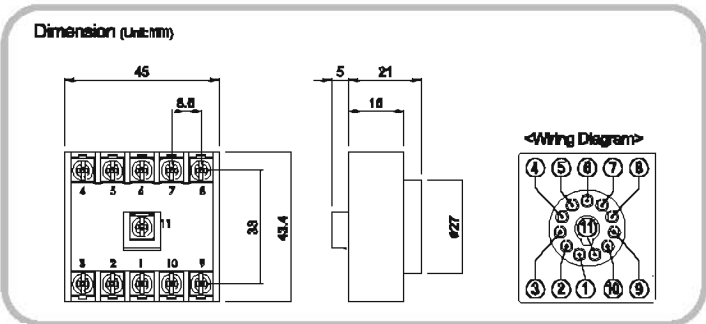

● **Hook sockets**



Model	PS-08
-------	-------

- One Touch for easy mounting on RAIL
- When mounting panel, Fix it with M4\*0.7 screw
- High heat resisting property and insulation resistance with PBT(UL94-V0 resin)-plated body.  
Improved electric capability and reliable connection with connection terminal made of copper alloy

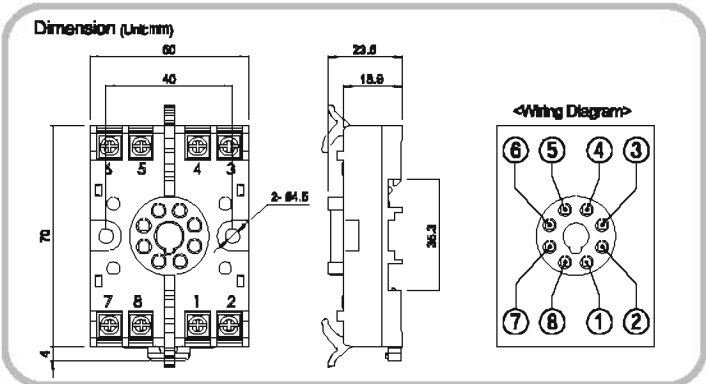

Push button switches

Push button switches (Illuminated)

Selector switches

Double push button switches

Start push button switches

Emergency switches

Emergency switches (Illuminated)

Pilot lamps

Accessory

Magnetic buzzers

Piezo buzzers

**Sockets**

Digital switches



● Hook sockets



Model	PS-11
-------	-------

- One Touch for easy mounting on RAIL
- When mounting panel, Fix it with M4\*0.7 screw
- High heat resisting property and insulation resistance with PBT(UL94-V0 resin)-plated body
- Improved electric capability and reliable connection with connection terminal made of copper alloy

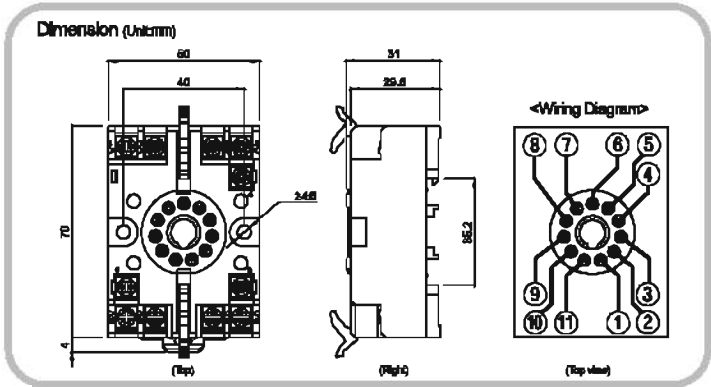

○ Hook Sockets

NEW



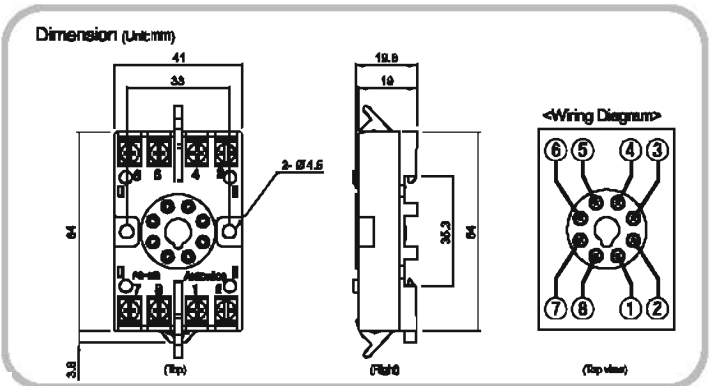

Model	PS-M8
-------	-------

- Well designed for 40mm width products (For ATS Series)
- One Touch for easy mounting on RAIL
- When mounting panel, Fix it with M4\*0.7 screw
- High heat resisting property and insulation resistance with PBT(UL94-V0 resin)-plated body
- Improved electric capability and reliable connection with connection terminal made of copper alloy



■ Digital switches series

Classification	Digital switches (Small)	Digital switches (Standard)	
		Relay pattern	Standard pattern
Model	AD105-I, B	AD604-I, B	AD605-I, B
Appearance			
Page	30	31	

Push button switches

Push button switches (Illuminated)

Selector switches

Double push button switches

■ Specifications

Model	AD105-I, B	AD604-I, B	AD605-I, B
Operation capacity	Max.500gf (4.9N)	Max.550gf (5.39N)	
Load capacity	5-28VDC, 1mA-0.1A	5-28VDC, 50VAC 50/60Hz 1mA-0.1A	
Continuous carry current	Max. 100mA	Max. 1A	
Contact resistance	Max. 200mΩ		
Insulation resistance	Between non-connected terminals Min. 100mΩ (at 250VDC for 1minute)		
	Between terminal and non-current carrying part Min. 100mΩ (at 500VDC for 1minute)		
Dielectric strength	Between non-connected terminals 250VAC 50/60Hz For 1 minute		600VAC 50/60Hz For 1 minute
	Between terminal and non-current carrying part 500VAC 50/60Hz For 1 minute		1000VAC 50/60Hz For 1 minute
Vibration resistance	0.75mm amplitude at frequency of 10-55Hz (for 1minute) in each of x,y,z directions for 1 hours		
Shock resistance	500m/s (50G) in each of x,y,z directions for 3 times		
Durability	Electrical	More than 20,000 times	
	Mechanical	More than 30,000 times	
Ambient temperature	-10 ~ 50 °C (at non-freezing status)		
Storage temperature	-20 ~ 80 °C (at non-freezing status)		
Ambient humidity	45 ~ 85%RH		
Unit weight	1.3g	4.2g	3.8g

Start push button switches

Emergency switches

Emergency switches (Illuminated)

Pilot lamps

Accessory

Magnetic buzzers

Piezo buzzers

Sockets

Digital switches



# D Digital switches

AD 1 0 5 - I  
 ① ② ③ ④ ⑤

Classification	Ordering Information					Description
	①	②	③	④	⑤	
Model	AD					AUTONICS DIGITAL SWITCH
Mounting size		1				16.5mm height
Display range			0			0-9
Pattern				5		Standard pattern
Case color					I	IVORY
					B	BLACK

※ Additional display range is ordered separately

## ○ Digital switches(Small)



Model	AD105-I
	AD105-B

※ Color : I, B

- Space-saving design
- Operations more than 30000 times present excellent electrical life.

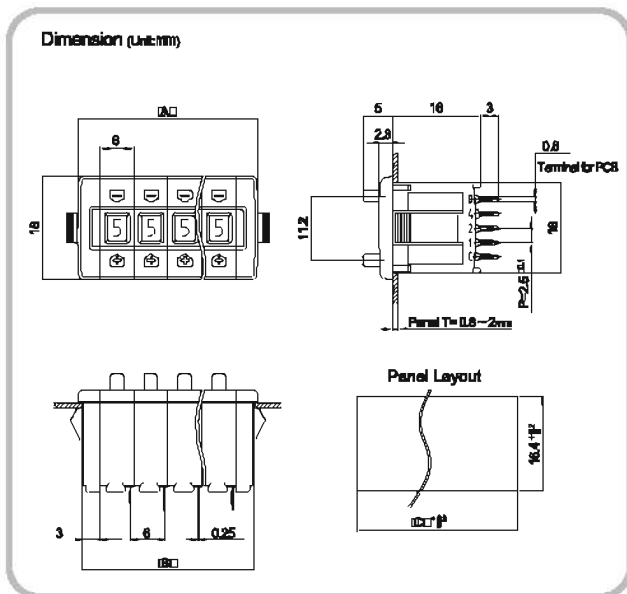

### <Output code number>

Model	AD105-I AD105-B	COM("C") Contact condition				COM
		1	2	4	8	
Preset position	0					•
	1	•				•
	2		•			•
	3	•	•			•
	4			•		•
	5	•		•		•
	6		•	•		•
	7	•	•	•		•
	8				•	•
	9	•			•	•

Number of Switches(n)	Unit:mm		
	Size A (n×8+8)	Size B (n×8+8)	Size C
1	14	12	12.5
2	20	18	18.5
3	28	24	24.5
4	32	30	30.5
5	38	38	36.5
6	44	42	42.5
7	50	48	48.5
8	58	54	54.5
9	62	60	60.5
10	68	68	66.5

※ Includes both side cover

AD 6 0 5 - I  
 ① ② ③ ④ ⑤

Classification	Ordering information					Description
	①	②	③	④	⑤	
Model	AD					AUTONICS DIGITAL SWITCH
Mounting size		6				22.5mm height
Display range			0			0-9
Pattern				4		Relay pattern
				5		Standard pattern
Case color					I	IVORY
					B	BLACK

\* Additional display range is ordered separately

○ Digital switches(Standard)



Model	AD604-I	AD605-I
	AD604-B	AD605-B

\* Color : I, B

- One Touch mounting type for easy installation.
- Visibility is increased by using wide display part

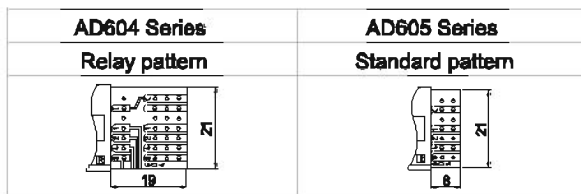

<Output code number>

Model	AD604-I AD604-B AD605-I AD605-B	COM("C") Contact condition				COM	Number of Switches(n)	Size A (n=8+6)	Size B (n=8+6)	Size C
		1	2	4	8					
Preset position	0					1	16	14	14.5	
	1	•				2	24	22	22.5	
	2	•	•			3	32	30	30.5	
	3	•	•	•		4	40	38	38.5	
	4	•	•	•	•	5	48	46	46.5	
	5	•	•	•	•	6	56	54	54.5	
	6	•	•	•	•	7	64	62	62.5	
	7	•	•	•	•	8	72	70	70.5	
	8	•	•	•	•	9	80	78	78.5	
	9	•	•	•	•	10	88	86	86.5	

\* Include both side cover

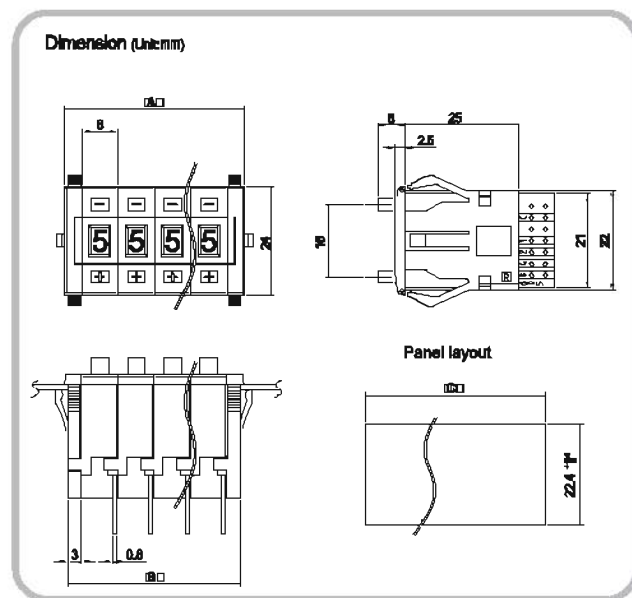

Push Button Switches

Push Button Switches (Illuminated)

Selector Switches

DOUBLE Push Button Switches

Start Push Button Switches

Emergency Switches

Emergency Switches (Illuminated)

Pilot Lamps

Accessory

Magnetic Buzzers

Piezo Buzzers

Sockets

Digital Switches

## ● Digital switches accessory

AD105 — L I  
 ① ② ③

Classification	Ordering Information	Description
	① — ② ③	
Model	AD105	AD105 Series
Cover	L	Left cover
	R	Right cover
Color	I	IVORY
	B	BLACK

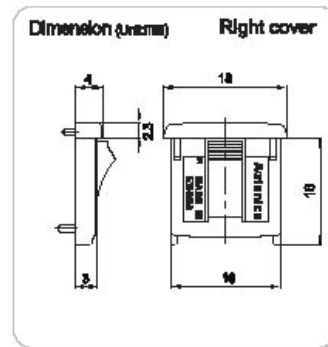
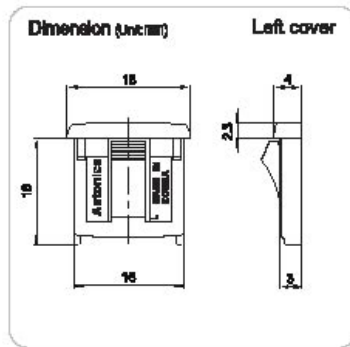

AD605 — L I  
 ① ② ③

Classification	Ordering Information	Description
	① — ② ③	
Model	AD605	AD605 Series
Cover	L	Left cover
	R	Right cover
Color	I	IVORY
	B	BLACK

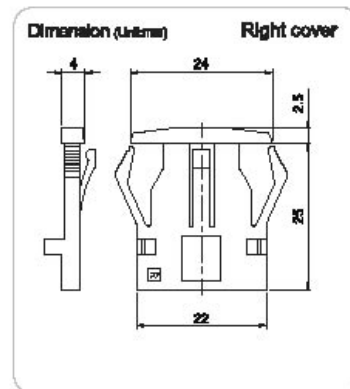
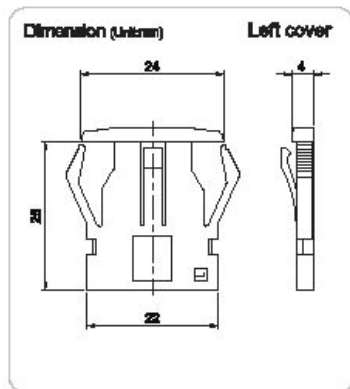

# Dreaming **ORANGE** World through **Autonics ORANGE** Solution

## **ORANGE** solution by **Autonics**

Orange is the corporate color of Autonics, and also implies unique IA solutions offered by Autonics. Autonics ORANGE solutions is a New and Advanced, Revolutionary and Economical sensing and control equipment offering the Optimized IA solution to the Global customers around the world.

### **Global partner for Industrial Automation**

## **Autonics Corporation**

### **Distributor**

#### ■ Major products

• Proximity sensors • Photoelectric sensors • Area sensors • Fiber optic sensors • Door/Door side sensors • Pressure sensors • Rotary encoders • Temperature controllers • Graphic/Logic panels • Field network devices • Counters • Timers • Temperature/humidity transducers • Power controllers • Panel meters • Tachometer/Pulse(Rate) meters • Display units • Sensor controllers • Switching power supplies • Control switches/Lamps/Buzzers/Socket • 2/5-phase stepping motors/ drivers • Motion controllers • Laser marking system(CO<sub>2</sub>, Nd:YAG) • Laser welding/soldering system

■ Any proposal for a product improvement and development: [Product@autonics.com](mailto:Product@autonics.com)

#### ◎ Headquarters

41-5, Yongdang-dong, Yangsan-si, Gyeongsang, 626-847, Korea

#### ☐ Overseas Business Dept.

Bldg. 402 3rd Fl., Bucheon Techno Park, 193, Yakdae-dong, Wonmi-gu, Bucheon-si, Gyeonggi-do, 420-734, Korea

Tel : 82-32-610-2730/ Fax : 82-32-328-0728 / E-mail : [sales@autonics.com](mailto:sales@autonics.com)

#### ■ Brazil Autonics do Brasil Comercial Importadora Exportadora Ltda

Tel : 55-11-3055-1680 / Fax : 55-11-3055-1861/ E-mail : [vendas@autonics.com.br](mailto:vendas@autonics.com.br)

#### ■ China Autonics electronic(Jilaxing) Corporation

Tel : 86-573-8218-1900 / Fax : 86-573-8218-1917 / E-mail : [china@autonics.com](mailto:china@autonics.com)

#### ■ India Autonics Automation India Pvt. Ltd.

Tel : 91-22-2781-4305 / Fax : 91-22-2781-4518 / E-mail : [india@autonics.com](mailto:india@autonics.com)

#### ■ Indonesia PT. Autonics Indonesia

Tel : 62-21-6586-8740 / Fax : 62-21-6586-8741 / E-mail : [Indonesia@autonics.com](mailto:Indonesia@autonics.com)

#### ■ Japan Autonics Japan Corporation

Tel : 81-3-5730-0568 / Fax : 81-3-5730-0569 / E-mail : [ja@autonicsjp.co.jp](mailto:ja@autonicsjp.co.jp)

#### ■ Malaysia Mal-Autonics Sensor Sdn. Bhd.

Tel : 60-3-7805-7190(Hunting) / Fax : 60-3-7805-7193 / E-mail : [malaysia@autonics.com](mailto:malaysia@autonics.com)

#### ■ Mexico Autonics Mexico Sales Office

Tel : 52-55-5207-0019 / Fax : 52-55-5207-0099 / E-mail : [ventas@autonics.com](mailto:ventas@autonics.com)

#### ■ Russia Autonics Corp. Russia Representative Office

Tel/Fax : Tel/Fax : 7-495-933-56-18 E-mail : [russia@autonics.com](mailto:russia@autonics.com)

#### ■ Turkey Autonics Otomasyon Ticaret Ltd. Sti.

Tel : 90-216-365-9117(9113, 9114) / Fax : 90-216-365-9112 / E-mail : [info@autonics.com.tr](mailto:info@autonics.com.tr)

#### ■ USA Autonics USA, Inc.

Tel : 1-847-680-8160 / Fax : 1-847-680-8155 / E-mail : [sales@autonicsusa.net](mailto:sales@autonicsusa.net)

#### ■ Vietnam Autonics Vietnam Corp.

Tel : 84-8-3925-6563 / Fax : 84-8-3925-6564 / E-mail : [vietnam@autonics.com](mailto:vietnam@autonics.com)