

# TLV2302, TLV2304

## FAMILY OF NANOPOWER OPERATIONAL AMPLIFIERS AND OPEN DRAIN COMPARATORS

SLOS343 – DECEMBER 2000

- **Micro-Power Operation . . . 1.4  $\mu$ A**
- **Input Common-Mode Range Exceeds the Rails . . .  $-0.1$  V to  $V_{CC} + 5$  V**
- **Supply Voltage Range . . . 2.5 V to 16 V**
- **Rail-to-Rail Input/Output (Amplifier)**
- **Reverse Battery Protection Up to 18 V**
- **Gain Bandwidth Product . . . 5.5 kHz (Amplifier)**
- **Open-Drain CMOS Output Stage (Comparator)**
- **Specified Temperature Range**  
–  $T_A = -40^\circ\text{C}$  to  $125^\circ\text{C}$  . . . Industrial Grade
- **Ultrasmall Packaging**  
– 8-Pin MSOP (TLV2302)
- **Universal Op-Amp EVM (See the SLOU060 for More Information)**

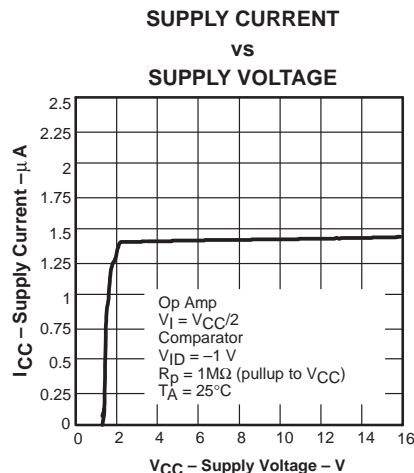
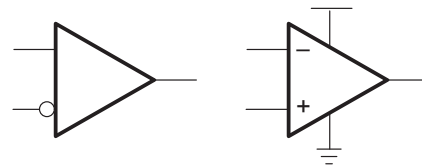

The TLV230x combines sub-micropower operational amplifier and comparator into a single package that produces excellent micropower signal conditioning with only 1.4  $\mu$ A of supply current. This combination gives the designer more board space and reduces part counts in systems that require an operational amplifier and comparator. The low supply current makes it an ideal choice for battery-powered portable applications where quiescent current is the primary concern. Reverse battery protection guards the amplifier from an over-current condition due to improper battery installation. For harsh environments, the inputs can be taken 5 V above the positive supply rail without damage to the device.

The TLV230x's low supply current is coupled with extremely low input bias currents enabling them to be used with mega-ohm resistors making them ideal for portable, long active life, applications. DC accuracy is ensured with a low typical offset voltage as low as 390  $\mu$ V, CMRR of 90 dB and minimum open loop gain of 130 V/mV at 2.7 V.

The maximum recommended supply voltage is as high as 16 V and ensured operation down to 2.5 V, with electrical characteristics specified at 2.7 V, 5 V, and 15 V. The 2.5-V operation makes it compatible with Li-Ion battery-powered systems and many micropower microcontrollers available today including TI's MSP430.

All members are available in PDIP and SOIC with the duals (one op-amp and one comparator) in the small MSOP package, and the quads (two operational amplifiers and two comparators) in the TSSOP package.

### A SELECTION OF OUTPUT COMPARATOR<sup>†</sup>

DEVICE	$V_{CC}$ (V)	$V_{IO}$ ( $\mu$ V)	$I_{CC}/\text{Ch}$ ( $\mu$ A)	GBW (kHz)	SR (V/ $\mu$ s)	$t_{PLH}$ ( $\mu$ s)	$t_{PHL}$ ( $\mu$ s)	$t_f$ ( $\mu$ s)	RAIL-TO-RAIL	OUTPUT STAGE
TLV230x	2.5 – 16	390	1.4 <sup>‡</sup>	5.5	0.0025	55	30	5	I/O	OD
TLV270x	2.5 – 16	390	1.4 <sup>‡</sup>	5.5	0.0025	55	30	5	I/O	PP
TLV240x	2.5 – 16	390	880	5.5	0.0025	—	—	—	I/O	—
TLV224x	2.5 – 12	600	1	5.5	0.002	—	—	—	I/O	—
TLV340x	2.5 – 16	250	0.47	—	—	55	30	5	I	OD
TLV370x	2.5 – 16	250	0.47	—	—	55	30	5	I	PP

<sup>†</sup> All specifications are typical values measured at 5 V.

<sup>‡</sup>  $I_{CC}$  is specified as one op-amp and one comparator.



Please be aware that an important notice concerning availability, standard warranty, and use in critical applications of Texas Instruments semiconductor products and disclaimers thereto appears at the end of this data sheet.

PRODUCTION DATA information is current as of publication date. Products conform to specifications per the terms of Texas Instruments standard warranty. Production processing does not necessarily include testing of all parameters.

**TEXAS  
INSTRUMENTS**

POST OFFICE BOX 655303 • DALLAS, TEXAS 75265

Copyright © 2000, Texas Instruments Incorporated

# TLV2302, TLV2304 FAMILY OF NANOPOWER OPERATIONAL AMPLIFIERS AND OPEN DRAIN COMPARATORS

SLOS343 – DECEMBER 2000

## TLV2302 AVAILABLE OPTIONS

T <sub>A</sub>	V <sub>IO</sub> max AT 25°C	PACKAGED DEVICES			
		SMALL OUTLINE† (D)	MSOP		PLASTIC DIP (P)
			MSOP† (DGK)	SYMBOLS	
-40°C to 125°C	4000 μV	TLV2302ID	TLV2302IDGK	xxTIAQG	TLV2302IP

† This package is available taped and reeled. To order this packaging option, add an R suffix to the part number (e.g., TLV2302IDR).

## TLV2304 AVAILABLE OPTIONS

T <sub>A</sub>	V <sub>IO</sub> max AT 25°C	PACKAGED DEVICES		
		SMALL OUTLINE† (D)	TSSOP (PW)	PLASTIC DIP (N)
-40°C to 125°C	4000 μV	TLV2304ID	TLV2304IPW	TLV2304IN

† This package is available taped and reeled. To order this packaging option, add an R suffix to the part number (e.g., TLV2304IDR).

## TLV230x PACKAGE PINOUTS

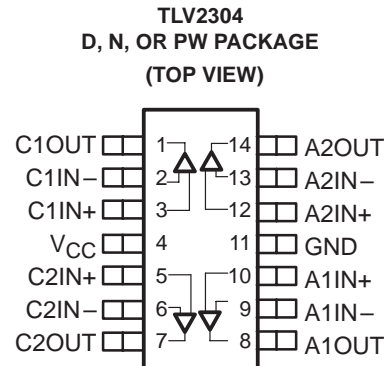
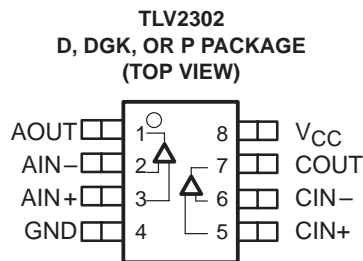

TLV2302, TLV2304  
**FAMILY OF NANOPOWER OPERATIONAL AMPLIFIERS  
AND OPEN DRAIN COMPARATORS**

SLOS343 – DECEMBER 2000

**absolute maximum ratings over operating free-air temperature range (unless otherwise noted)†**

Supply voltage, $V_{CC}$ (see Note 1)	17 V
Differential input voltage, $V_{ID}$	$V_{CC}$
Input voltage range, $V_I$ (see Notes 1 and 2)	0 to $V_{CC} + 5$ V
Input current range, $I_I$ (any input)	$\pm 10$ mA
Output current range, $I_O$	$\pm 10$ mA
Continuous total power dissipation	See Dissipation Rating Table
Operating free-air temperature range, $T_A$ : I suffix	$-40^\circ\text{C}$ to $125^\circ\text{C}$
Maximum junction temperature, $T_J$	$150^\circ\text{C}$
Storage temperature range, $T_{stg}$	$-65^\circ\text{C}$ to $150^\circ\text{C}$
Lead temperature 1,6 mm (1/16 inch) from case for 10 seconds	$260^\circ\text{C}$

† Stresses beyond those listed under “absolute maximum ratings” may cause permanent damage to the device. These are stress ratings only, and functional operation of the device at these or any other conditions beyond those indicated under “recommended operating conditions” is not implied. Exposure to absolute-maximum-rated conditions for extended periods may affect device reliability.

- NOTES: 1. All voltage values, except differential voltages, are with respect to GND  
2. Input voltage range is limited to 20 V max or  $V_{CC} + 5$  V, whichever is smaller.

**DISSIPATION RATING TABLE**

PACKAGE	$\Theta_{JC}$ ( $^\circ\text{C}/\text{W}$ )	$\Theta_{JA}$ ( $^\circ\text{C}/\text{W}$ )	$T_A \leq 25^\circ\text{C}$ POWER RATING	$T_A = 125^\circ\text{C}$ POWER RATING
D (8)	38.3	176	710 mW	142 mW
D (14)	26.9	122.3	1022 mW	204.4 mW
DGK (8)	54.2	259.9	481 mW	96.2 mW
N (14)	32	78	1600 mW	320.5 mW
P (8)	41	104	1200 mW	240.4 mW
PW (14)	29.3	173.6	720 mW	144 mW

**recommended operating conditions**

		MIN	MAX	UNIT
Supply voltage, $V_{CC}$	Single supply	2.5	16	V
	Split supply	$\pm 1.25$	$\pm 8$	
Common-mode input voltage range, $V_{ICR}$	Amplifier and comparator	-0.1	$V_{CC}+5$	V
Operating free-air temperature, $T_A$		-40	125	$^\circ\text{C}$



# TLV2302, TLV2304

## FAMILY OF NANOPOWER OPERATIONAL AMPLIFIERS AND OPEN DRAIN COMPARATORS

SLOS343 – DECEMBER 2000

electrical characteristics at recommended operating conditions,  $V_{CC} = 2.7, 5 \text{ V}$ , and  $15 \text{ V}$  (unless otherwise noted)

### amplifier dc performance

PARAMETER		TEST CONDITIONS	$T_A^\dagger$	MIN	TYP	MAX	UNIT
$V_{IO}$	Input offset voltage	$V_O = V_{CC}/2 \text{ V}$ , $V_{IC} = V_{CC}/2 \text{ V}$ , $R_S = 50 \Omega$	25°C	390	4000		$\mu\text{V}$
			Full range		6000		
$\alpha V_{IO}$	Offset voltage draft		25°C	3			$\mu\text{V}/^\circ\text{C}$
CMRR	Common-mode rejection ratio	$V_{IC} = 0 \text{ to } V_{CC}$ , $R_S = 50 \Omega$	$V_{CC} = 2.7 \text{ V}$	25°C	55	73	dB
				Full range	52		
			$V_{CC} = 5 \text{ V}$	25°C	60	80	
				Full range	55		
			$V_{CC} = 15 \text{ V}$	25°C	66	90	
				Full range	60		
AVD	Large-signal differential voltage amplification	$V_{CC} = 2.7 \text{ V}$ , $V_{O(pp)} = 1.5 \text{ V}$ , $R_L = 500 \text{ k}\Omega$	25°C	130	400	V/mV	
			Full range	30			
			$V_{CC} = 5 \text{ V}$ , $V_{O(pp)} = 3 \text{ V}$ , $R_L = 500 \text{ k}\Omega$	25°C	300		1000
				Full range	100		
			$V_{CC} = 15 \text{ V}$ , $V_{O(pp)} = 8 \text{ V}$ , $R_L = 500 \text{ k}\Omega$	25°C	400		1400
				Full range	120		
PSRR	Power supply rejection ratio ( $\Delta V_{CC}/\Delta V_{IO}$ )	$V_{IC} = V_{CC}/2 \text{ V}$ , No load	$V_{CC} = 2.7 \text{ to } 5 \text{ V}$	25°C	90	120	dB
				Full range	85		
			$V_{CC} = 5 \text{ to } 15 \text{ V}$	25°C	94	120	
				Full range	90		

$^\dagger$  Full range is  $-40^\circ\text{C}$  to  $125^\circ\text{C}$ .

### amplifier and comparator input characteristics

PARAMETER		TEST CONDITIONS	$T_A^\dagger$	MIN	TYP	MAX	UNIT
$I_{IO}$	Input offset current	$V_O = V_{CC}/2 \text{ V}$ , $V_{IC} = V_{CC}/2 \text{ V}$ , $R_p = 1 \text{ M}\Omega$ (pullup to $V_{CC}$ ), $R_S = 50 \Omega$	25°C		25	250	pA
			0 to 70°C			300	
			Full range			500	
$I_{IB}$	Input bias current		25°C		100	500	pA
			0 to 70°C			550	
			Full range			1000	
$r_{i(d)}$	Differential input resistance		25°C		300		M $\Omega$
$C_{i(c)}$	Common-mode input capacitance	$f = 100 \text{ kHz}$	25°C		3		pF

$^\dagger$  Full range is  $-40^\circ\text{C}$  to  $125^\circ\text{C}$ .



TLV2302, TLV2304  
**FAMILY OF NANOPOWER OPERATIONAL AMPLIFIERS  
AND OPEN DRAIN COMPARATORS**

SLOS343 – DECEMBER 2000

electrical characteristics at recommended operating conditions,  $V_{CC} = 2.7, 5 \text{ V}$ , and  $15 \text{ V}$  (unless otherwise noted) (continued)

**amplifier output characteristics**

PARAMETER		TEST CONDITIONS	$T_A$ †	MIN	TYP	MAX	UNIT
$V_{OH}$	High-level output voltage	$V_{IC} = V_{CC}/2$ , $I_{OH} = -50 \mu\text{A}$	25°C	2.55		2.65	V
				Full range	2.5		
			25°C	4.85		4.95	
				Full range	4.8		
			25°C	14.85		14.95	
				Full range	14.8		
$V_{OL}$	Low-level output voltage	$V_{IC} = V_{CC}/2$ , $I_{OL} = 50 \mu\text{A}$	25°C	180	260	mV	
			Full range	300			
$I_O$	Output current	$V_O = 0.5 \text{ V}$ from rail	25°C	±200		μA	

† Full range is  $-40^\circ\text{C}$  to  $125^\circ\text{C}$ .

**amplifier dynamic performance**

PARAMETER		TEST CONDITIONS	$T_A$	MIN	TYP	MAX	UNIT
UGBW	Unity gain bandwidth	$R_L = 500 \text{ k}\Omega$ , $C_L = 100 \text{ pF}$	25°C	5.5			kHz
SR	Slew rate at unity gain	$V_{O(pp)} = 0.8 \text{ V}$ , $R_L = 500 \text{ k}\Omega$ , $C_L = 100 \text{ pF}$	25°C	2.5			V/ms
$\phi_M$	Phase margin	$R_L = 500 \text{ k}\Omega$ , $C_L = 100 \text{ pF}$	25°C	60°			
	Gain margin			15			dB
$t_s$	Settling time	$V_{CC} = 2.7 \text{ or } 5 \text{ V}$ , $V(\text{STEP})_{PP} = 1 \text{ V}$ , $A_V = -1$ , $C_L = 100 \text{ pF}$ , $R_L = 100 \text{ k}\Omega$	25°C	0.1%		1.84	ms
				0.1%		6.1	
				0.01%		32	
$V_n$	Equivalent input noise voltage	$f = 0.1 \text{ to } 10 \text{ Hz}$	25°C	5.3			$\mu\text{V}_{pp}$
				$f = 100 \text{ Hz}$	500		
$I_n$	Equivalent input noise current	$f = 100 \text{ Hz}$	25°C	8			$\text{fA}/\sqrt{\text{Hz}}$

**supply current**

PARAMETER		TEST CONDITIONS	$T_A$ †	MIN	TYP	MAX	UNIT
$I_{CC}$	Supply current (one op-amp and one comparator)	$R_p = \text{No pullup}$ , Output state high	$V_{CC} = 2.7 \text{ V or } 5 \text{ V}$	25°C	1.4		μA
			$V_{CC} = 15 \text{ V}$	25°C	1.4	1.7	
				Full range	2.3		
Reverse supply current		$V_{CC} = -18 \text{ V}$ , $V_I = 0 \text{ V}$ , $V_O = \text{open}$	25°C	50			nA

† Full range is  $-40^\circ\text{C}$  to  $125^\circ\text{C}$ .



# TLV2302, TLV2304

## FAMILY OF NANOPOWER OPERATIONAL AMPLIFIERS AND OPEN DRAIN COMPARATORS

SLOS343 – DECEMBER 2000

electrical characteristics at recommended operating conditions,  $V_{CC} = 2.7, 5 \text{ V}$ , and  $15 \text{ V}$  (unless otherwise noted) (continued)

### comparator dc performance

PARAMETER	TEST CONDITIONS†	$T_A$ †	MIN	TYP	MAX	UNIT
$V_{IO}$ Input offset voltage	$V_{IC} = V_{CC}/2$ , $R_S = 50 \Omega$ , $R_P = 1 \text{ M}\Omega$ (pullup to $V_{CC}$ )	25°C		250	5000	$\mu\text{V}$
		Full range			7000	
$\alpha_{VIO}$ Offset voltage drift		25°C		3		$\mu\text{V}/^\circ\text{C}$
CMRR Common-mode rejection ratio	$V_{IC} = 0$ to $V_{CC}$ , $R_S = 50 \Omega$	$V_{CC} = 2.7 \text{ V}$	25°C	55	72	dB
			Full range		50	
		$V_{CC} = 5 \text{ V}$	25°C	60	76	
			Full range		55	
		$V_{CC} = 15 \text{ V}$	25°C	65	88	
			Full range		60	
$A_{VD}$ Large-signal differential voltage amplification	$R_P = 1 \text{ M}\Omega$ (pullup to $V_{CC}$ )	25°C		1000		$\text{V}/\text{mV}$
PSRR Power supply rejection ratio ( $\Delta V_{CC}/\Delta V_{IO}$ )	$V_{IC} = V_{CC}/2 \text{ V}$ , No load	$V_{CC} = 2.7$ to $5 \text{ V}$	25°C	75	100	dB
			Full range		70	
		$V_{CC} = 5$ to $15 \text{ V}$	25°C	85	105	
			Full range		80	

† Full range is  $-40^\circ\text{C}$  to  $125^\circ\text{C}$ .

### comparator output characteristics

PARAMETER	TEST CONDITIONS†	$T_A$ †	MIN	TYP	MAX	UNIT
$I_{OZ}$ High-impedance output leakage current	$V_{IC} = V_{CC}/2$ , $V_O = V_{CC}$ , $V_{ID} = 1 \text{ V}$	25°C		50		$\mu\text{A}$
$V_{OL}$ Low-level output voltage	$V_{IC} = V_{CC}/2$ , $I_{OL} = 50 \mu\text{A}$ , $V_{ID} = -1 \text{ V}$	25°C		80	200	$\text{mV}$
		Full range			300	

† Full range is  $-40^\circ\text{C}$  to  $125^\circ\text{C}$ .

switching characteristics at recommended operating conditions,  $V_{CC} = 2.7 \text{ V}$ ,  $5 \text{ V}$ ,  $15 \text{ V}$  (unless otherwise noted)

PARAMETER	TEST CONDITIONS	$T_A$	MIN	TYP	MAX	UNIT	
$t_{(PLH)}$ Propagation delay time, low-to-high-level output	$f = 10 \text{ kHz}$ , $V_{STEP} = 1 \text{ V}$ , $C_L = 10 \text{ pF}$ , $R_P = 1 \text{ M}\Omega$ (pullup to $V_{CC}$ )	25°C		175		$\mu\text{s}$	
			Overdrive = 10 mV		55		
			Overdrive = 50 mV		25		
$t_{(PHL)}$ Propagation delay time, high-to-low-level output		25°C	Overdrive = 2 mV		300		
			Overdrive = 10 mV		60		
			Overdrive = 50 mV		30		
$t_f$ Fall time	$C_L = 10 \text{ pF}$	25°C		5		$\mu\text{s}$	

NOTE: The response time specified is the interval between the input step function and the instant when the output crosses 1.4 V.



**TYPICAL CHARACTERISTICS**

**Table of Graphs**

			<b>FIGURE</b>
$V_{IO}$	Input offset voltage	vs Common-mode input voltage	1, 2
$I_{IB}$	Input bias current	vs Free-air temperature	3, 5, 7
		vs Common-mode input voltage	4, 6
$I_{IO}$	Input offset current	vs Free-air temperature	3, 5, 7
		vs Common-mode input voltage	4, 6
$I_{CC}$	Supply current	vs Supply voltage	8
		vs Free-air temperature	9
<b>Amplifier</b>			
CMRR	Common-mode rejection ratio	vs Frequency	10
$V_{OH}$	High-level output voltage	vs High-level output current	11, 13
$V_{OL}$	Low-level output voltage	vs Low-level output current	12, 14
$V_{O(PP)}$	Output voltage, peak-to-peak	vs Frequency	15
PSRR	Power supply rejection ratio	vs Frequency	16
	Voltage noise over a 10 Second Period		17
$\phi_m$	Phase margin	vs Capacitive load	18
$A_{VD}$	Differential voltage gain	vs Frequency	19
	Phase	vs Frequency	19
	Gain bandwidth product	vs Supply voltage	20
SR	Slew rate	vs Free-air temperature	21
	Large signal follower pulse response		22
	Small signal follower pulse response		23
	Large signal inverting pulse response		24
	Small signal inverting pulse response		25
<b>Comparator</b>			
$V_{OL}$	Low-level output voltage	vs Low-level output current	26, 27
	Open collector leakage current	vs Free-air temperature	28
	Output fall time	vs Supply voltage	29
	Low-to-high level output response for various input overdrives		30, 31
	High-to-low level output response for various input overdrives		32, 33

# TLV2302, TLV2304 FAMILY OF NANOPOWER OPERATIONAL AMPLIFIERS AND OPEN DRAIN COMPARATORS

SLOS343 – DECEMBER 2000

## AMPLIFIER AND COMPARATOR TYPICAL CHARACTERISTICS

**INPUT OFFSET VOLTAGE  
vs  
COMMON-MODE INPUT  
VOLTAGE**

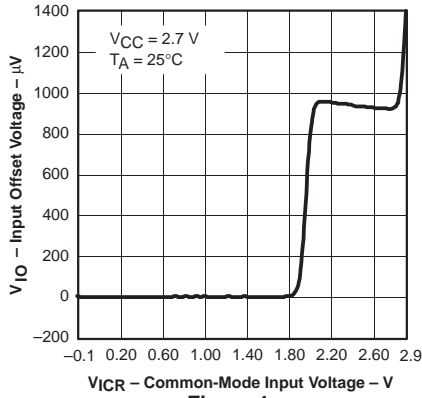

Figure 1

**INPUT OFFSET VOLTAGE  
vs  
COMMON-MODE INPUT  
VOLTAGE**

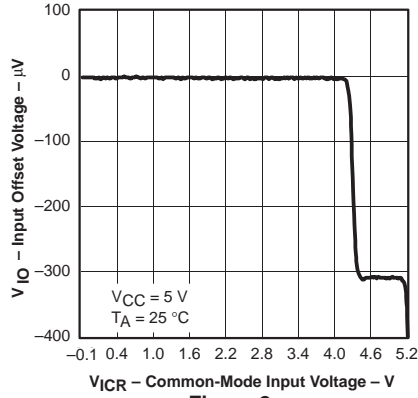

Figure 2

**INPUT BIAS / OFFSET CURRENT  
vs  
FREE-AIR TEMPERATURE**

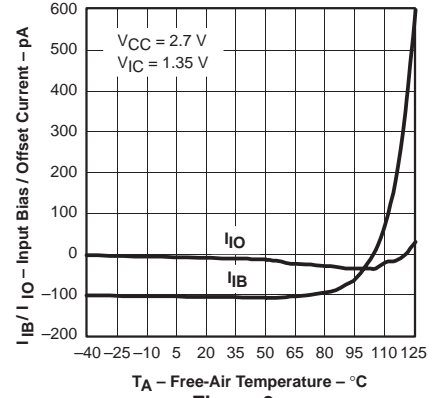

Figure 3

**INPUT BIAS/OFFSET CURRENT  
vs  
COMMON-MODE INPUT  
VOLTAGE**

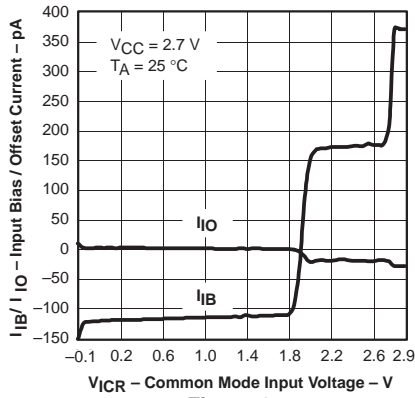

Figure 4

**INPUT BIAS/OFFSET CURRENT  
vs  
FREE-AIR TEMPERATURE**

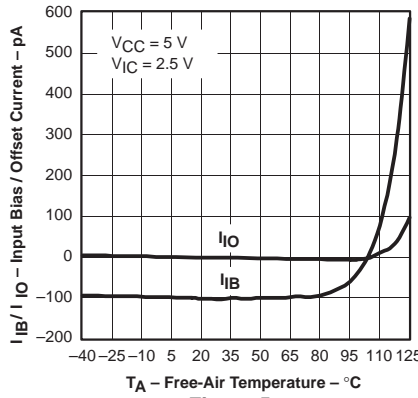

Figure 5

**INPUT BIAS/OFFSET CURRENT  
vs  
COMMON-MODE INPUT  
VOLTAGE**

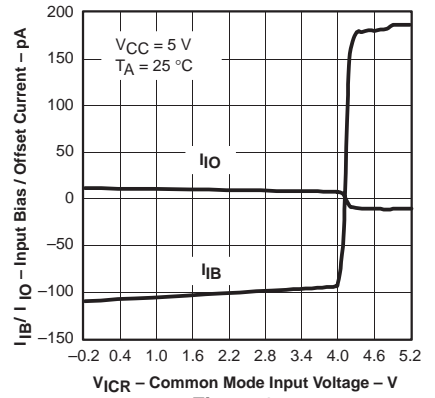

Figure 6

**INPUT BIAS/OFFSET CURRENT  
vs  
FREE-AIR TEMPERATURE**

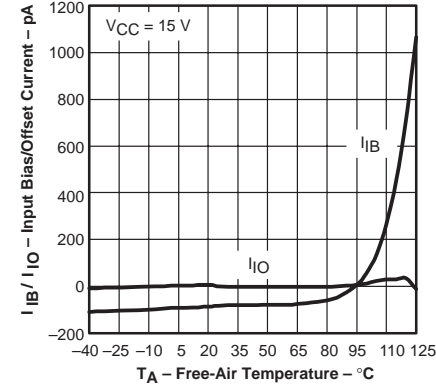

Figure 7

**SUPPLY CURRENT  
vs  
SUPPLY VOLTAGE**

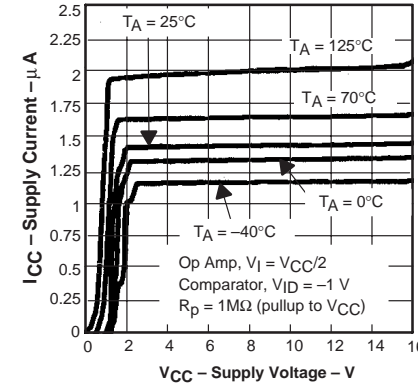

Figure 8

**SUPPLY CURRENT  
vs  
FREE-AIR TEMPERATURE**

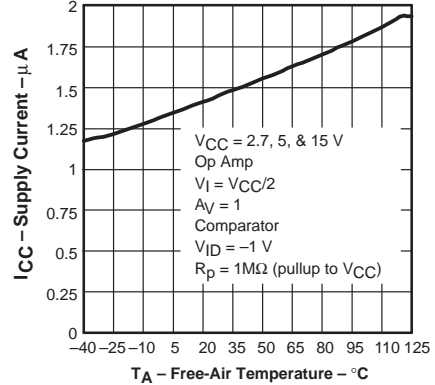

Figure 9





AMPLIFIER TYPICAL CHARACTERISTICS

COMMON-MODE REJECTION RATIO  
 VS  
 FREQUENCY

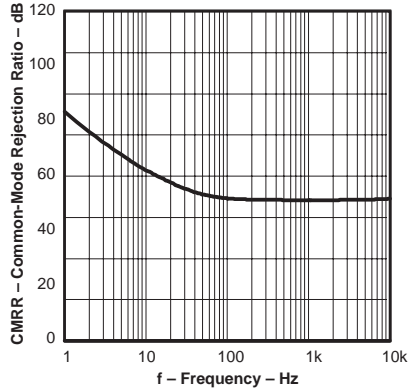

Figure 10

HIGH-LEVEL OUTPUT VOLTAGE  
 VS  
 HIGH-LEVEL OUTPUT CURRENT

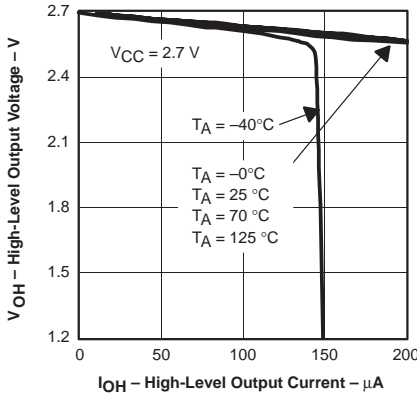

Figure 11

LOW-LEVEL OUTPUT VOLTAGE  
 VS  
 LOW-LEVEL OUTPUT CURRENT

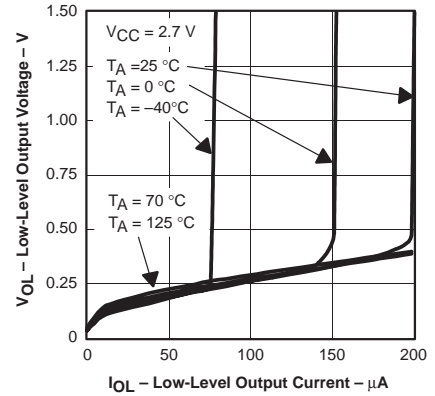

Figure 12

HIGH-LEVEL OUTPUT VOLTAGE  
 VS  
 HIGH-LEVEL OUTPUT CURRENT

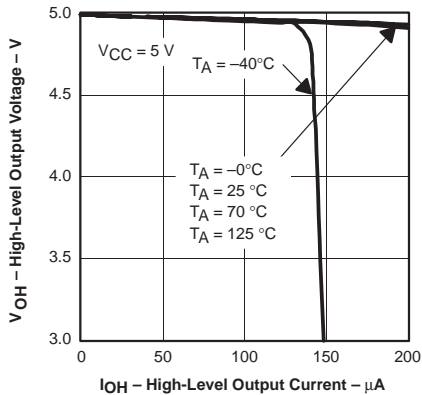

Figure 13

LOW-LEVEL OUTPUT VOLTAGE  
 VS  
 LOW-LEVEL OUTPUT CURRENT

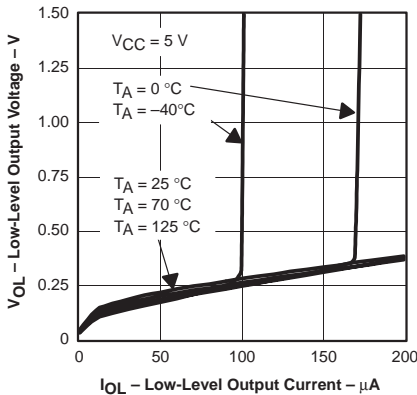

Figure 14

OUTPUT VOLTAGE  
 PEAK-TO-PEAK  
 VS  
 FREQUENCY

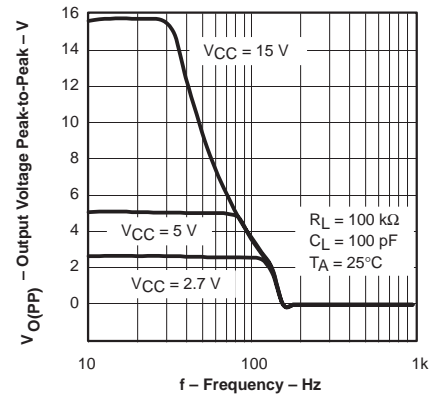

Figure 15

POWER SUPPLY REJECTION RATIO  
 VS  
 FREQUENCY

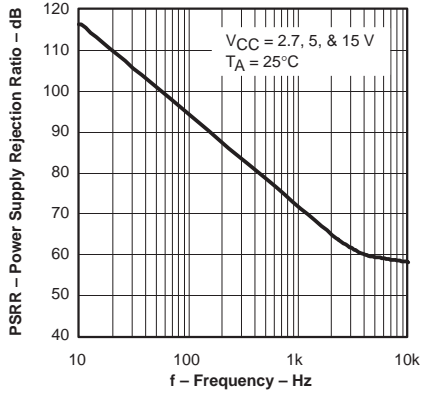

Figure 16

VOLTAGE NOISE  
 OVER A 10 SECOND PERIOD

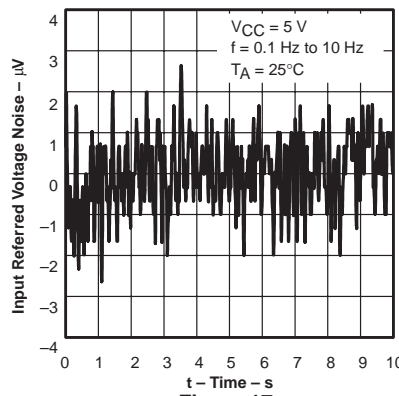

Figure 17

PHASE MARGIN  
 VS  
 CAPACITIVE LOAD

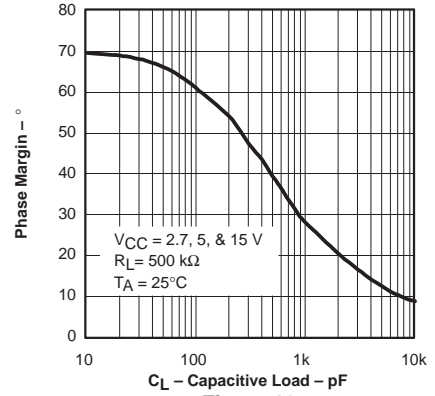

Figure 18

# TLV2302, TLV2304 FAMILY OF NANOPOWER OPERATIONAL AMPLIFIERS AND OPEN DRAIN COMPARATORS

SLOS343 – DECEMBER 2000

## AMPLIFIER TYPICAL CHARACTERISTICS

**DIFFERENTIAL VOLTAGE GAIN AND PHASE  
vs  
FREQUENCY**

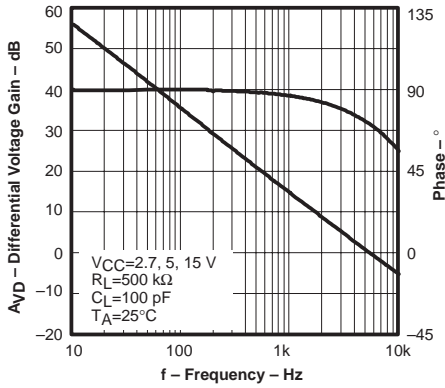

Figure 19

**GAIN BANDWIDTH PRODUCT  
vs  
SUPPLY VOLTAGE**

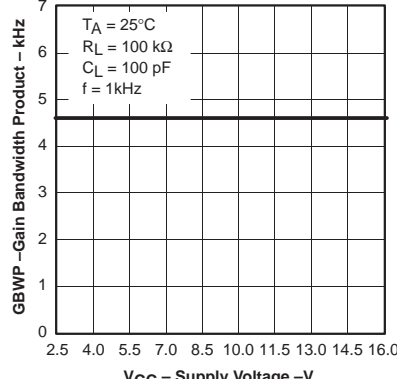

Figure 20

**SLEW RATE  
vs  
FREE-AIR TEMPERATURE**

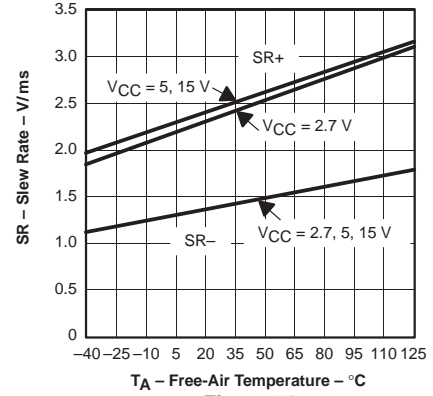

Figure 21

**LARGE SIGNAL FOLLOWER  
PULSE RESPONSE**

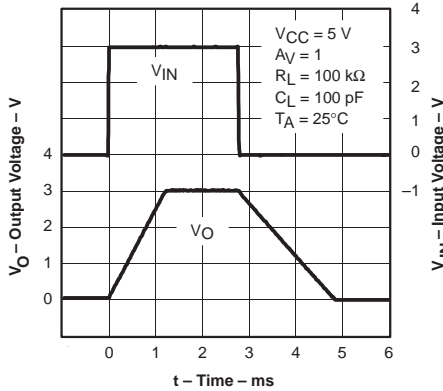

Figure 22

**SMALL SIGNAL FOLLOWER  
PULSE RESPONSE**

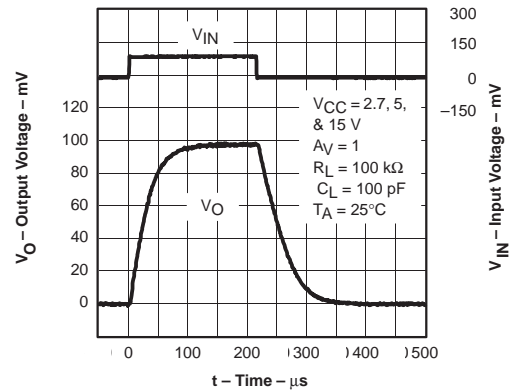

Figure 23

**LARGE SIGNAL INVERTING  
PULSE RESPONSE**

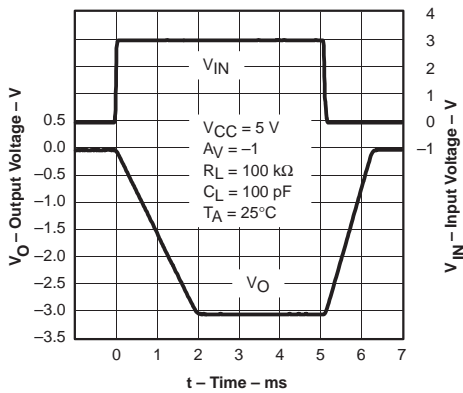

Figure 24

**SMALL SIGNAL INVERTING  
PULSE RESPONSE**

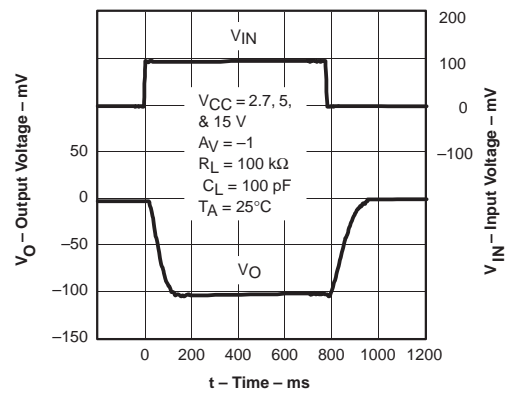

Figure 25

COMPARATOR TYPICAL CHARACTERISTICS

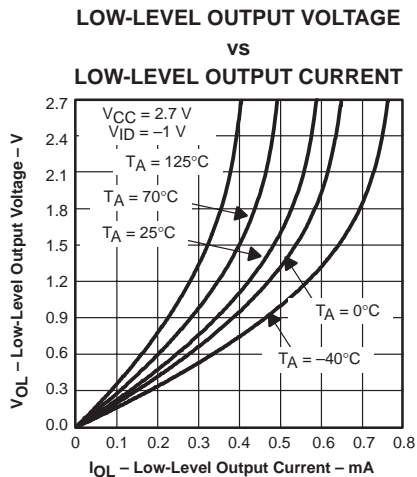

Figure 26

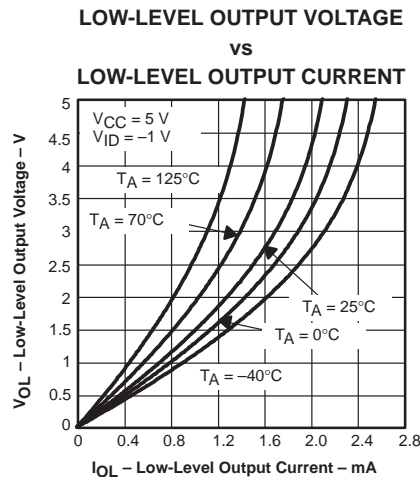

Figure 27

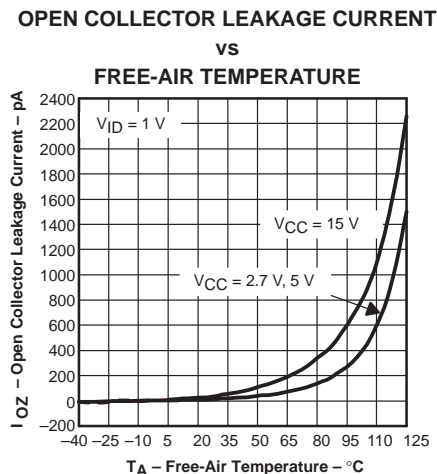

Figure 28

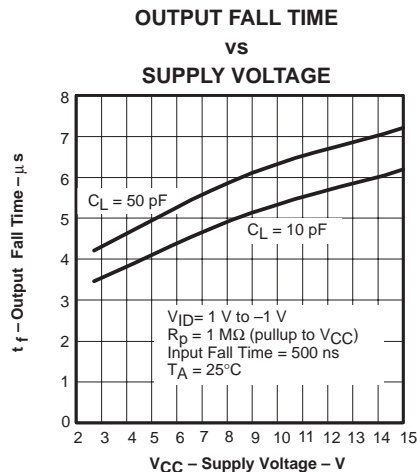

Figure 29

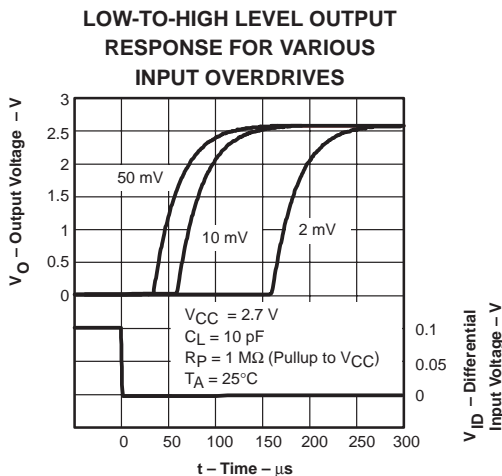

Figure 30

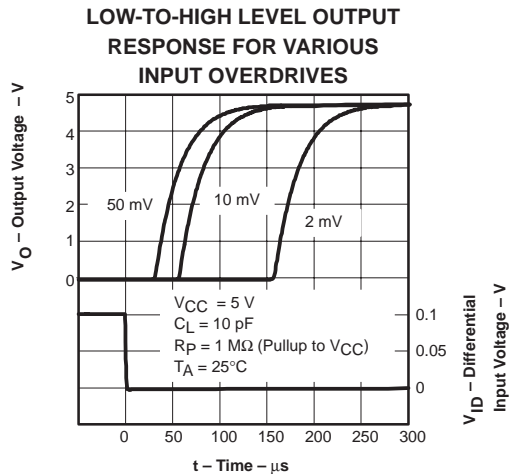
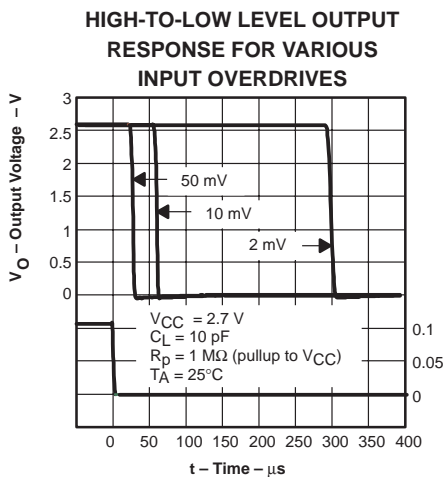
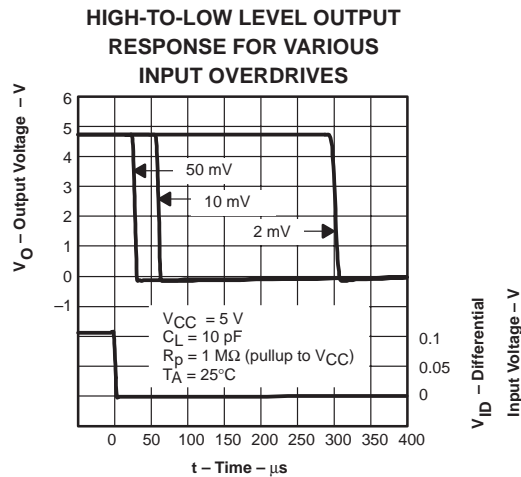

Figure 31

**COMPARATOR TYPICAL CHARACTERISTICS**



**Figure 32**



**Figure 33**

**APPLICATION INFORMATION**

**reverse battery protection**

The TLV2302/4 is protected against reverse battery voltage up to 18 V. When subjected to reverse battery condition, the supply current is typically less than 100 nA at 25°C (inputs grounded and outputs open). This current is determined by the leakage of six Schottky diodes and will therefore increase as the ambient temperature increases.

When subjected to reverse battery conditions and negative voltages applied to the inputs or outputs, the input ESD structure will turn on—this current should be limited to less than 10 mA. If the inputs or outputs are referred to ground, rather than midrail, no extra precautions need be taken.

**common-mode input range**

The TLV2302/4 has rail-rail input and outputs. For common-mode inputs from  $-0.1\text{ V}$  to  $V_{CC} - 0.8\text{ V}$  a PNP differential pair will provide the gain.

For inputs between  $V_{CC} - 0.8\text{ V}$  and  $V_{CC}$ , two NPN emitter followers buffering a second PNP differential pair provide the gain. This special combination of NPN/PNP differential pair enables the inputs to be taken 5 V above the rails; because as the inputs go above  $V_{CC}$ , the NPNs switch from functioning as transistors to functioning as diodes. This will lead to an increase in input bias current. The second PNP differential pair continues to function normally as the inputs exceed  $V_{CC}$ .

The TLV2302/4 has a negative common-input range that exceeds ground by 100 mV. If the inputs are taken much below this, reduced open loop gain will be observed with the ultimate possibility of phase inversion.

## APPLICATION INFORMATION

### offset voltage

The output offset voltage, ( $V_{OO}$ ) is the sum of the input offset voltage ( $V_{IO}$ ) and both input bias currents ( $I_{IB}$ ) times the corresponding gains. The following schematic and formula can be used to calculate the output offset voltage.

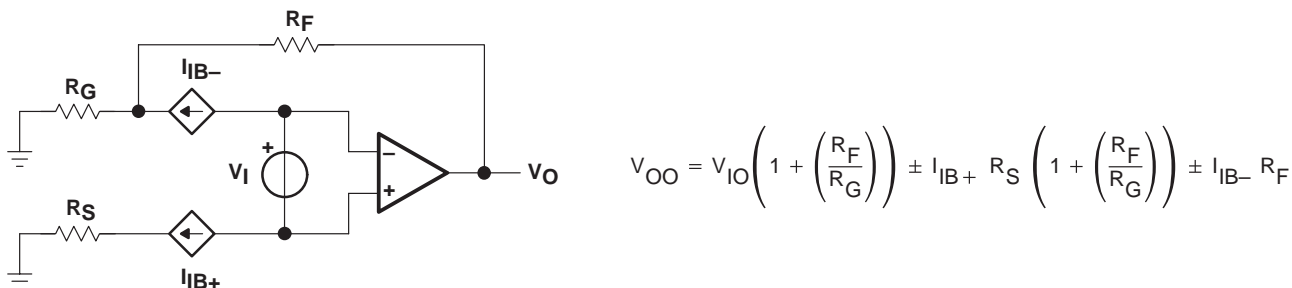

**Figure 34. Output Offset Voltage Model**

### general configurations

When receiving low-level signals, limiting the bandwidth of the incoming signals into the system is often required. The simplest way to accomplish this is to place an RC filter at the noninverting terminal of the amplifier (see Figure 35).

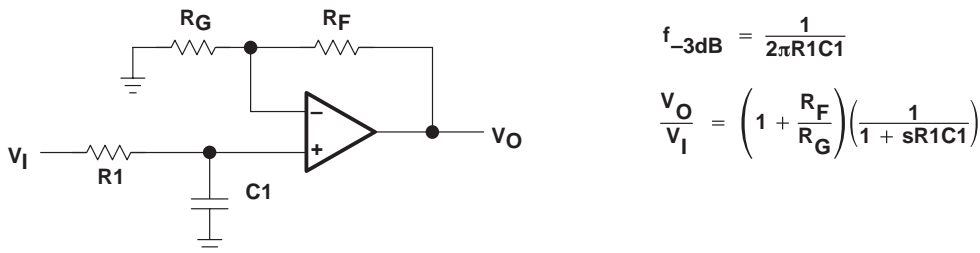

**Figure 35. Single-Pole Low-Pass Filter**

If even more attenuation is needed, a multiple pole filter is required. The Sallen-Key filter can be used for this task. For best results, the amplifier should have a bandwidth that is 8 to 10 times the filter frequency bandwidth. Failure to do this can result in phase shift of the amplifier.

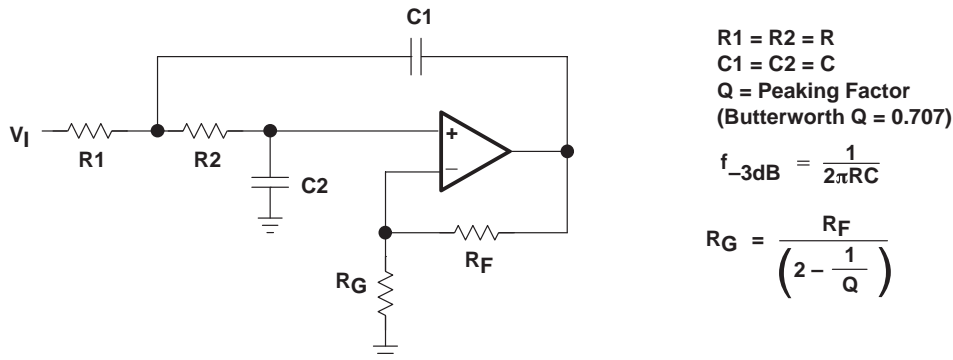

**Figure 36. 2-Pole Low-Pass Sallen-Key Filter**

## APPLICATION INFORMATION

### circuit layout considerations

To achieve the levels of high performance of the TLV230x, follow proper printed-circuit board design techniques. A general set of guidelines is given in the following.

- Ground planes—It is highly recommended that a ground plane be used on the board to provide all components with a low inductive ground connection. However, in the areas of the amplifier inputs and output, the ground plane can be removed to minimize the stray capacitance.
- Proper power supply decoupling—Use a 6.8- $\mu$ F tantalum capacitor in parallel with a 0.1- $\mu$ F ceramic capacitor on each supply terminal. It may be possible to share the tantalum among several amplifiers depending on the application, but a 0.1- $\mu$ F ceramic capacitor should always be used on the supply terminal of every amplifier. In addition, the 0.1- $\mu$ F capacitor should be placed as close as possible to the supply terminal. As this distance increases, the inductance in the connecting trace makes the capacitor less effective. The designer should strive for distances of less than 0.1 inches between the device power terminals and the ceramic capacitors.
- Sockets—Sockets can be used but are not recommended. The additional lead inductance in the socket pins will often lead to stability problems. Surface-mount packages soldered directly to the printed-circuit board is the best implementation.
- Short trace runs/compact part placements—Optimum high performance is achieved when stray series inductance has been minimized. To realize this, the circuit layout should be made as compact as possible, thereby minimizing the length of all trace runs. Particular attention should be paid to the inverting input of the amplifier. Its length should be kept as short as possible. This will help to minimize stray capacitance at the input of the amplifier.
- Surface-mount passive components—Using surface-mount passive components is recommended for high performance amplifier circuits for several reasons. First, because of the extremely low lead inductance of surface-mount components, the problem with stray series inductance is greatly reduced. Second, the small size of surface-mount components naturally leads to a more compact layout thereby minimizing both stray inductance and capacitance. If leaded components are used, it is recommended that the lead lengths be kept as short as possible.

## APPLICATION INFORMATION

### general power dissipation considerations

For a given  $\theta_{JA}$ , the maximum power dissipation is shown in Figure 37 and is calculated by the following formula:

$$P_D = \left( \frac{T_{MAX} - T_A}{\theta_{JA}} \right)$$

Where:

- $P_D$  = Maximum power dissipation of TLV230x IC (watts)
- $T_{MAX}$  = Absolute maximum junction temperature (150°C)
- $T_A$  = Free-ambient air temperature (°C)
- $\theta_{JA}$  =  $\theta_{JC} + \theta_{CA}$
- $\theta_{JC}$  = Thermal coefficient from junction to case
- $\theta_{CA}$  = Thermal coefficient from case to ambient air (°C/W)

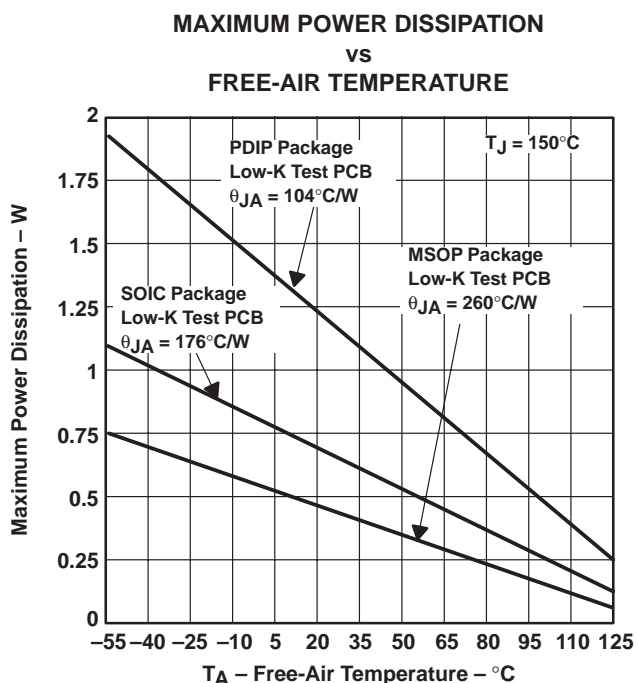

NOTE A: Results are with no air flow and using JEDEC Standard Low-K test PCB.

**Figure 37. Maximum Power Dissipation vs Free-Air Temperature**

# TLV2302, TLV2304 FAMILY OF NANOPOWER OPERATIONAL AMPLIFIERS AND OPEN DRAIN COMPARATORS

SLOS343 – DECEMBER 2000

## APPLICATION INFORMATION

### amplifier macromodel information

Macromodel information provided was derived using Microsim *Parts*™ Release 8, the model generation software used with Microsim *PSpice*™. The Boyle macromodel (see Note 2) and subcircuit in Figure 38 are generated using the TLV230x typical electrical and operating characteristics at  $T_A = 25^\circ\text{C}$ . Using this information, output simulations of the following key parameters can be generated to a tolerance of 20% (in most cases):

- Maximum positive output voltage swing
- Maximum negative output voltage swing
- Slew rate
- Quiescent power dissipation
- Input bias current
- Open-loop voltage amplification
- Unity-gain frequency
- Common-mode rejection ratio
- Phase margin
- DC output resistance
- AC output resistance
- Short-circuit output current limit

NOTE 3: G. R. Boyle, B. M. Cohn, D. O. Pederson, and J. E. Solomon, "Macromodeling of Integrated Circuit Operational Amplifiers", *IEEE Journal of Solid-State Circuits*, SC-9, 353 (1974).

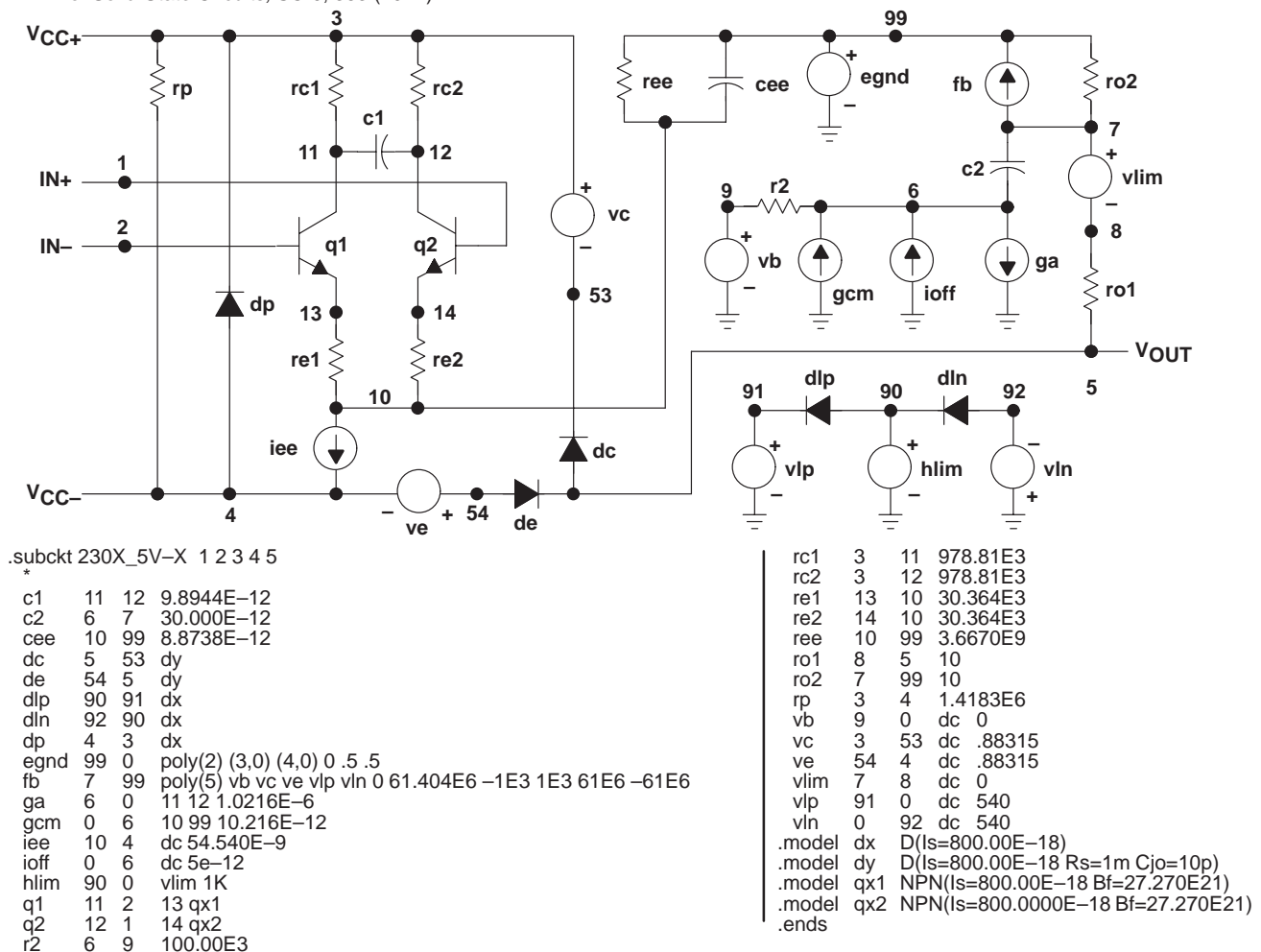

Figure 38. Boyle Macromodels and Subcircuit

*PSpice* and *Parts* are trademarks of MicroSim Corporation.



POST OFFICE BOX 655303 • DALLAS, TEXAS 75265



**MECHANICAL DATA**

**D (R-PDSO-G\*\*)**

**PLASTIC SMALL-OUTLINE PACKAGE**

14 PIN SHOWN

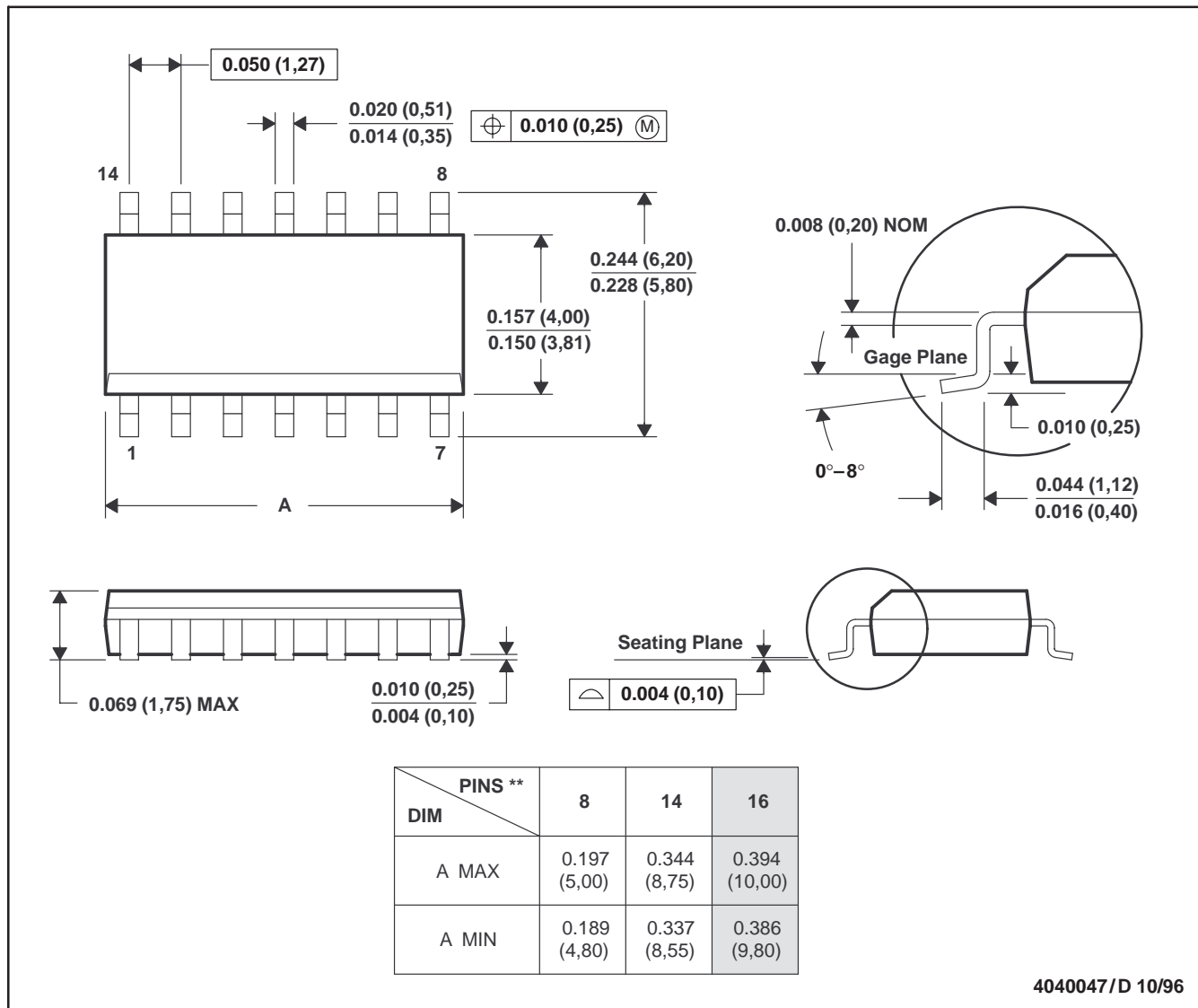

- NOTES: A. All linear dimensions are in inches (millimeters).  
 B. This drawing is subject to change without notice.  
 C. Body dimensions do not include mold flash or protrusion, not to exceed 0.006 (0,15).

**TLV2302, TLV2304**  
**FAMILY OF NANOPOWER OPERATIONAL AMPLIFIERS**  
**AND OPEN DRAIN COMPARATORS**

SLOS343 – DECEMBER 2000

**MECHANICAL INFORMATION**

**DGK (R-PDSO-G8)**

**PLASTIC SMALL-OUTLINE PACKAGE**

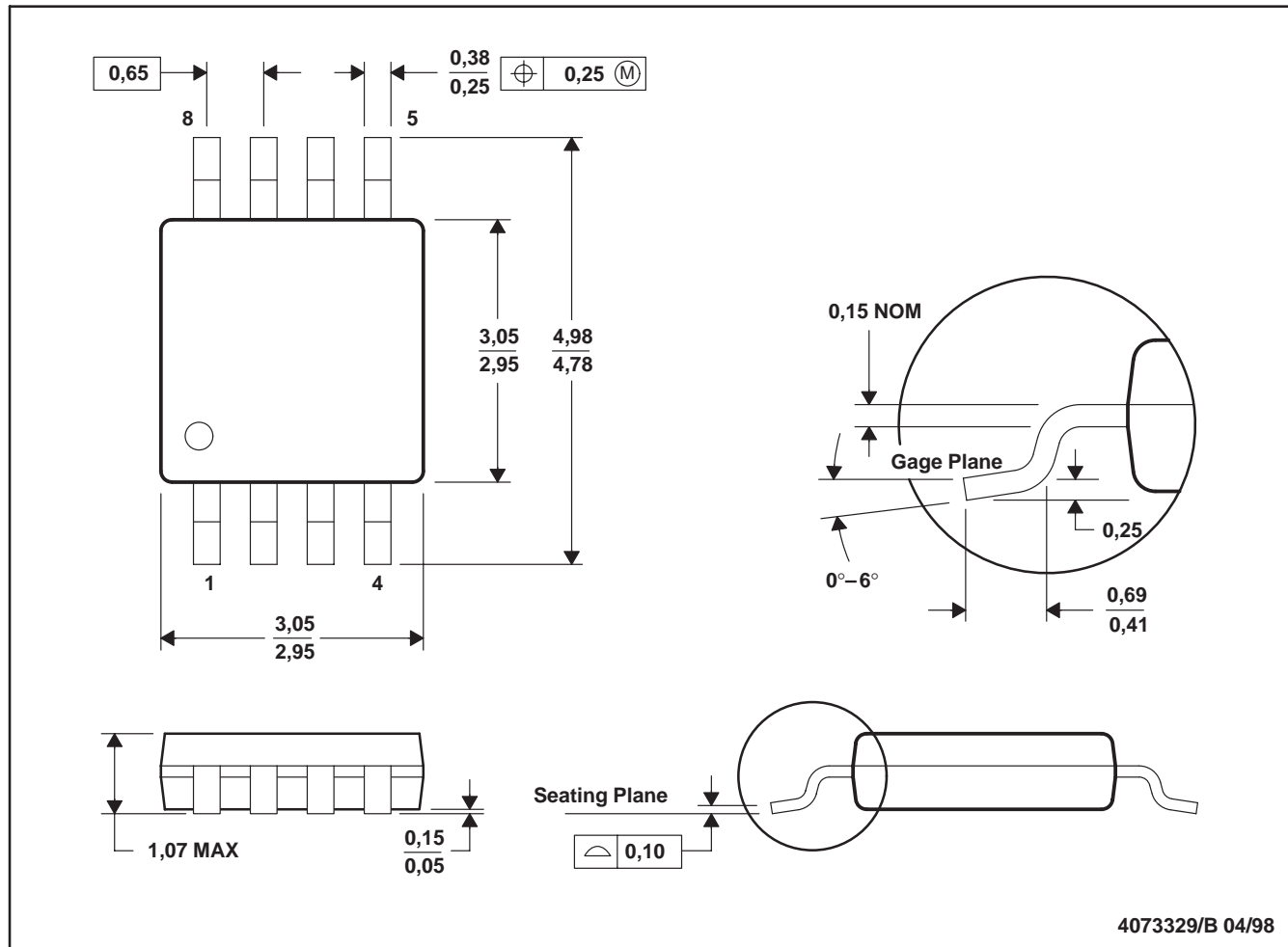

4073329/B 04/98

- NOTES: A. All linear dimensions are in millimeters.  
 B. This drawing is subject to change without notice.  
 C. Body dimensions do not include mold flash or protrusion.  
 D. Falls within JEDEC MO-187



POST OFFICE BOX 655303 • DALLAS, TEXAS 75265

**MECHANICAL INFORMATION**

**N (R-PDIP-T\*\*)**

**PLASTIC DUAL-IN-LINE PACKAGE**

16 PINS SHOWN

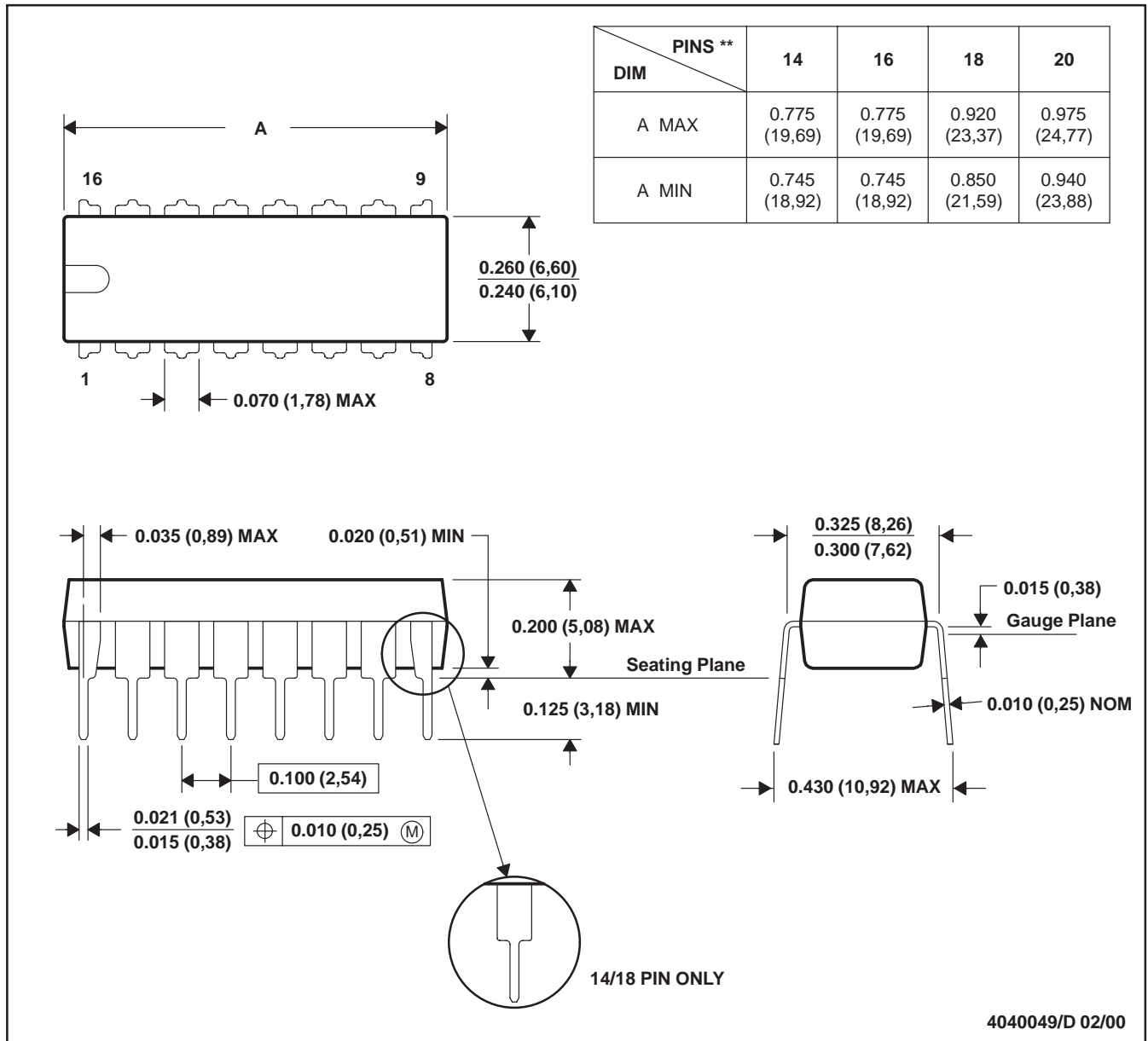

- NOTES: A. All linear dimensions are in inches (millimeters).  
 B. This drawing is subject to change without notice.  
 C. Falls within JEDEC MS-001 (20-pin package is shorter than MS-001).

**TLV2302, TLV2304**  
**FAMILY OF NANOPOWER OPERATIONAL AMPLIFIERS**  
**AND OPEN DRAIN COMPARATORS**

SLOS343 – DECEMBER 2000

**MECHANICAL INFORMATION**

**P (R-PDIP-T8)**

**PLASTIC DUAL-IN-LINE PACKAGE**

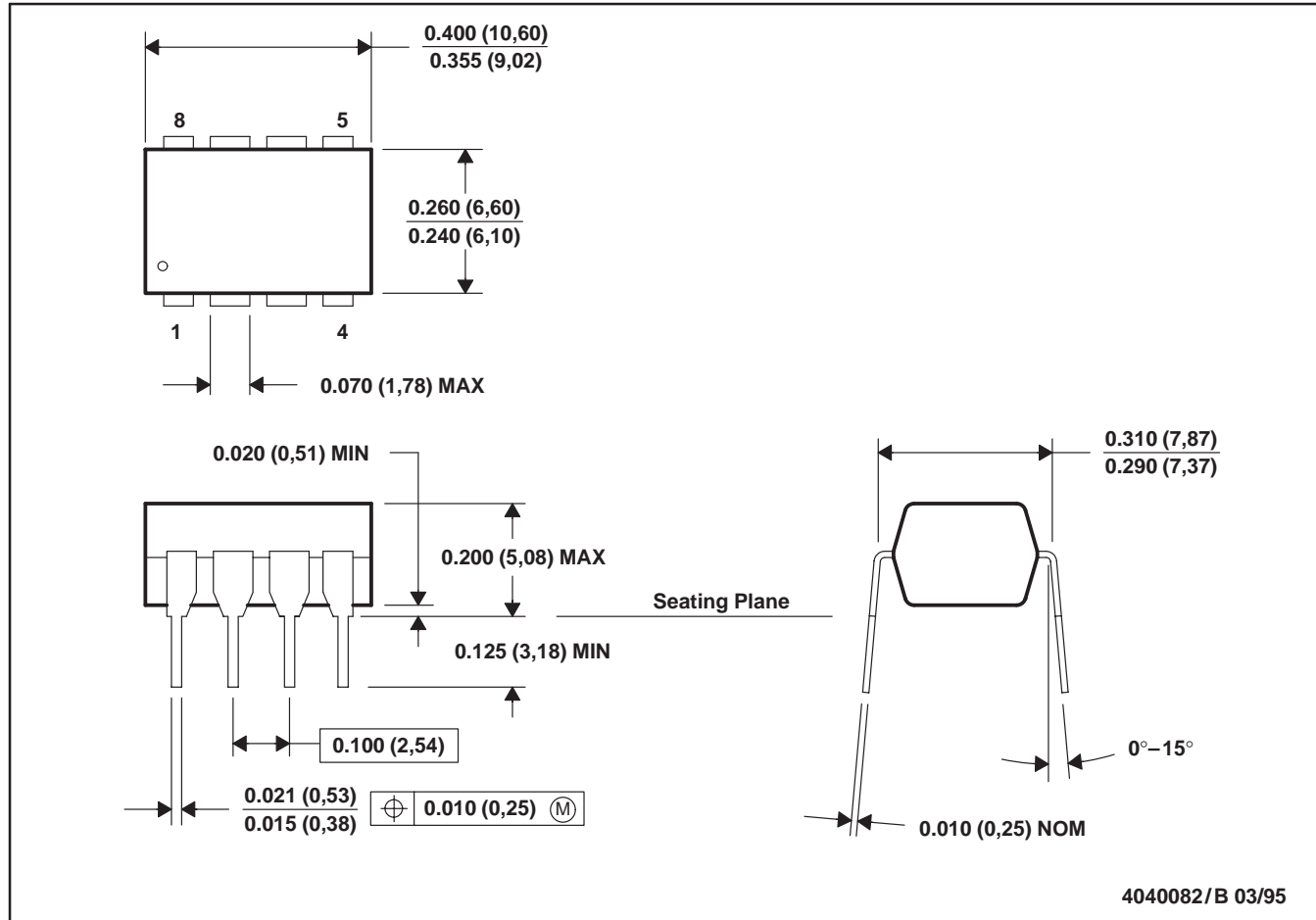

- NOTES: A. All linear dimensions are in inches (millimeters).  
 B. This drawing is subject to change without notice.  
 C. Falls within JEDEC MS-001

**MECHANICAL INFORMATION**

**PW (R-PDSO-G\*\*)**

**PLASTIC SMALL-OUTLINE PACKAGE**

14 PINS SHOWN

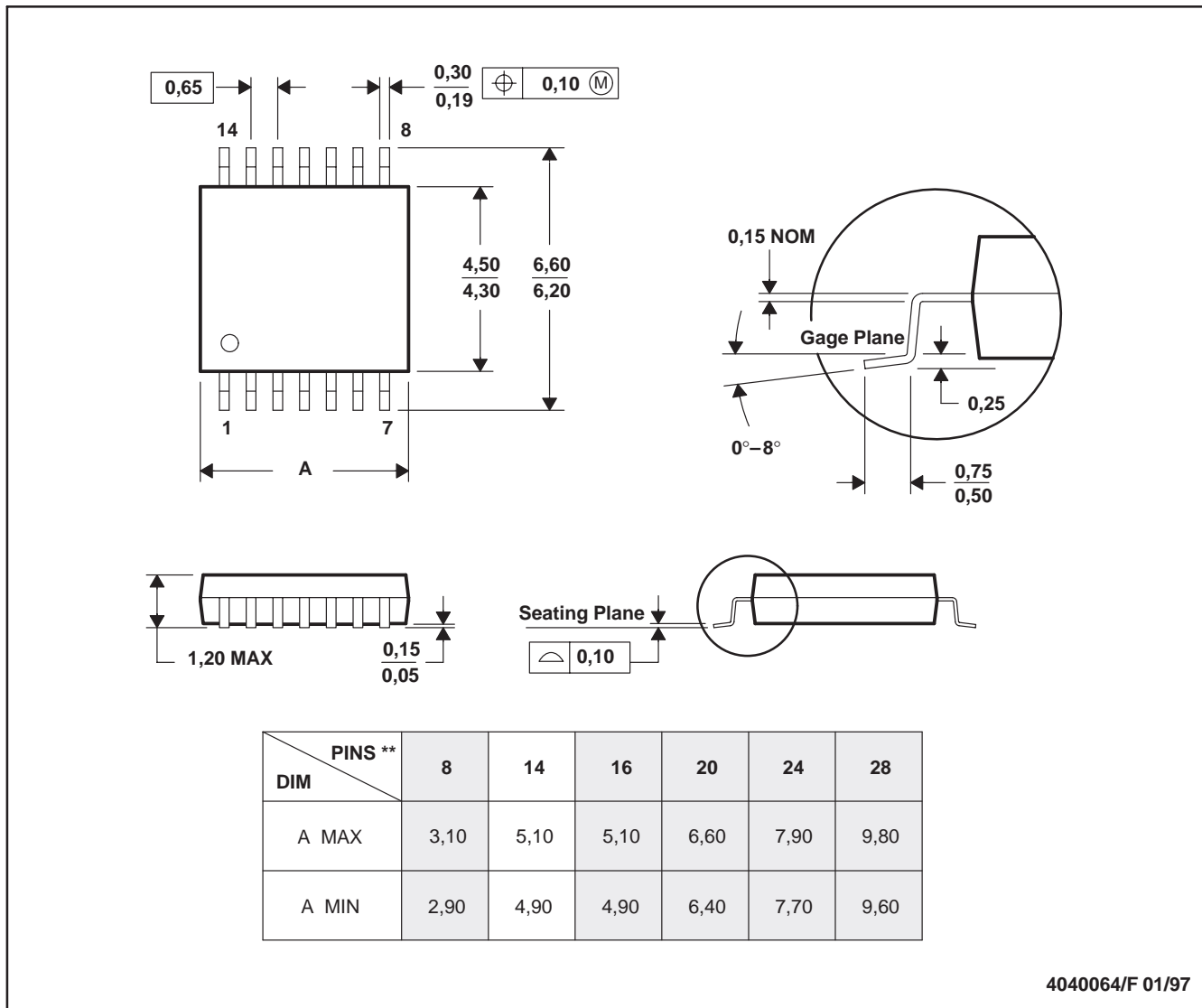

- NOTES: A. All linear dimensions are in millimeters.  
 B. This drawing is subject to change without notice.  
 C. Body dimensions do not include mold flash or protrusion not to exceed 0,15.  
 D. Falls within JEDEC MO-153

## **IMPORTANT NOTICE**

Texas Instruments and its subsidiaries (TI) reserve the right to make changes to their products or to discontinue any product or service without notice, and advise customers to obtain the latest version of relevant information to verify, before placing orders, that information being relied on is current and complete. All products are sold subject to the terms and conditions of sale supplied at the time of order acknowledgment, including those pertaining to warranty, patent infringement, and limitation of liability.

TI warrants performance of its semiconductor products to the specifications applicable at the time of sale in accordance with TI's standard warranty. Testing and other quality control techniques are utilized to the extent TI deems necessary to support this warranty. Specific testing of all parameters of each device is not necessarily performed, except those mandated by government requirements.

Customers are responsible for their applications using TI components.

In order to minimize risks associated with the customer's applications, adequate design and operating safeguards must be provided by the customer to minimize inherent or procedural hazards.

TI assumes no liability for applications assistance or customer product design. TI does not warrant or represent that any license, either express or implied, is granted under any patent right, copyright, mask work right, or other intellectual property right of TI covering or relating to any combination, machine, or process in which such semiconductor products or services might be or are used. TI's publication of information regarding any third party's products or services does not constitute TI's approval, warranty or endorsement thereof.