

TLV2721, TLV2721Y
Advanced LinCMOS™ RAIL-TO-RAIL
VERY LOW-POWER SINGLE OPERATIONAL AMPLIFIERS
 SLOS197A – AUGUST 1997 – REVISED MARCH 2001

- **Output Swing Includes Both Supply Rails**
- **Low Noise . . . 19 nV/√Hz Typ at f = 1 kHz**
- **Low Input Bias Current . . . 1 pA Typ**
- **Fully Specified for Single-Supply 3-V and 5-V Operation**
- **Very Low Power . . . 110 μA Typ**
- **Common-Mode Input Voltage Range Includes Negative Rail**
- **Wide Supply Voltage Range 2.7 V to 10 V**
- **Macromodel Included**

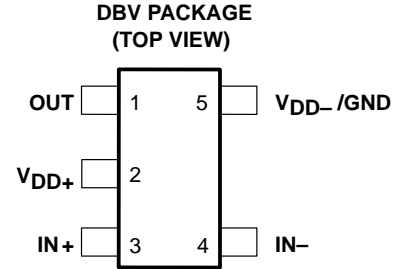

description

The TLV2721 is a single low-voltage operational amplifier available in the SOT-23 package. It offers a compromise between the ac performance and output drive of the TLV2731 and the micropower TLV2711.

It consumes only 150 μA (max) of supply current and is ideal for battery-powered applications. The device exhibits rail-to-rail output performance for increased dynamic range in single- or split-supply applications. The TLV2721 is fully characterized at 3 V and 5 V and is optimized for low-voltage applications.

The TLV2721, exhibiting high input impedance and low noise, is excellent for small-signal conditioning for high-impedance sources, such as piezoelectric transducers. Because of the micropower dissipation levels combined with 3-V operation, these devices work well in hand-held monitoring and remote-sensing applications. In addition, the rail-to-rail output feature with single or split supplies makes this family a great choice when interfacing with analog-to-digital converters (ADCs).

With a total area of 5.6mm², the SOT-23 package only requires one third the board space of the standard 8-pin SOIC package. This ultra-small package allows designers to place single amplifiers very close to the signal source, minimizing noise pick-up from long PCB traces.

AVAILABLE OPTIONS

T _A	V _{IO} max AT 25°C	PACKAGED DEVICES	SYMBOL	CHIP FORM‡ (Y)
		SOT-23 (DBV)†		
0°C to 70°C	3 mV	TLV2721CDBV	VAKC	TLV2721Y
-40°C to 85°C	3 mV	TLV2721IDBV	VAKI	

† The DBV package available in tape and reel only.

‡ Chip forms are tested at T_A = 25°C only.



Please be aware that an important notice concerning availability, standard warranty, and use in critical applications of Texas Instruments semiconductor products and disclaimers thereto appears at the end of this data sheet.

Advanced LinCMOS is a trademark of Texas Instruments.

PRODUCTION DATA information is current as of publication date. Products conform to specifications per the terms of Texas Instruments standard warranty. Production processing does not necessarily include testing of all parameters.



Copyright © 2001, Texas Instruments Incorporated

TLV2721, TLV2721Y
Advanced LinCMOS™ RAIL-TO-RAIL
VERY LOW-POWER SINGLE OPERATIONAL AMPLIFIERS

SLOS197A – AUGUST 1997 – REVISED MARCH 2001

TLV2721Y chip information

This chip, when properly assembled, displays characteristics similar to the TLV2721C. Thermal compression or ultrasonic bonding may be used on the doped-aluminum bonding pads. This chip may be mounted with conductive epoxy or a gold-silicon preform.

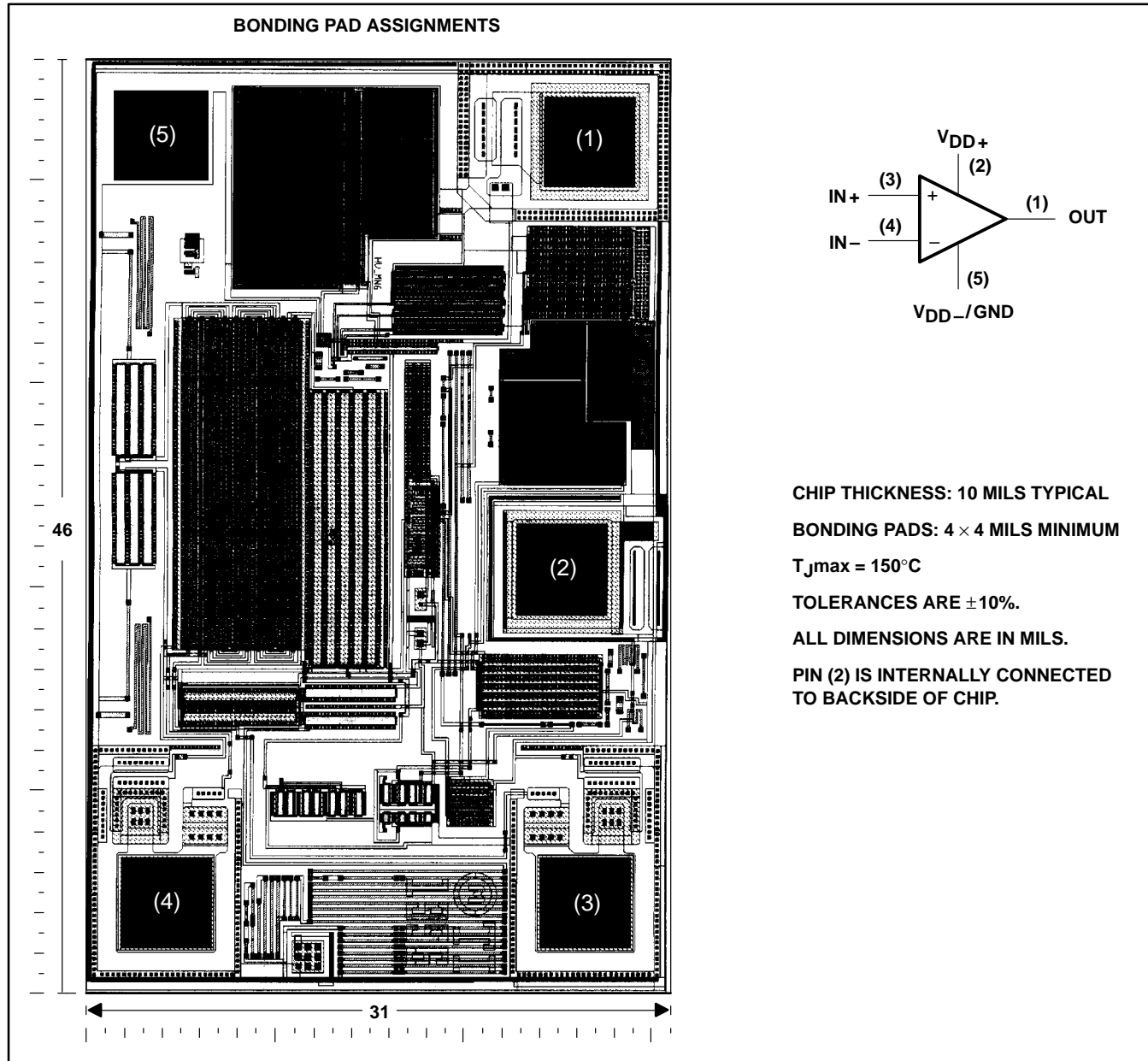

equivalent schematic

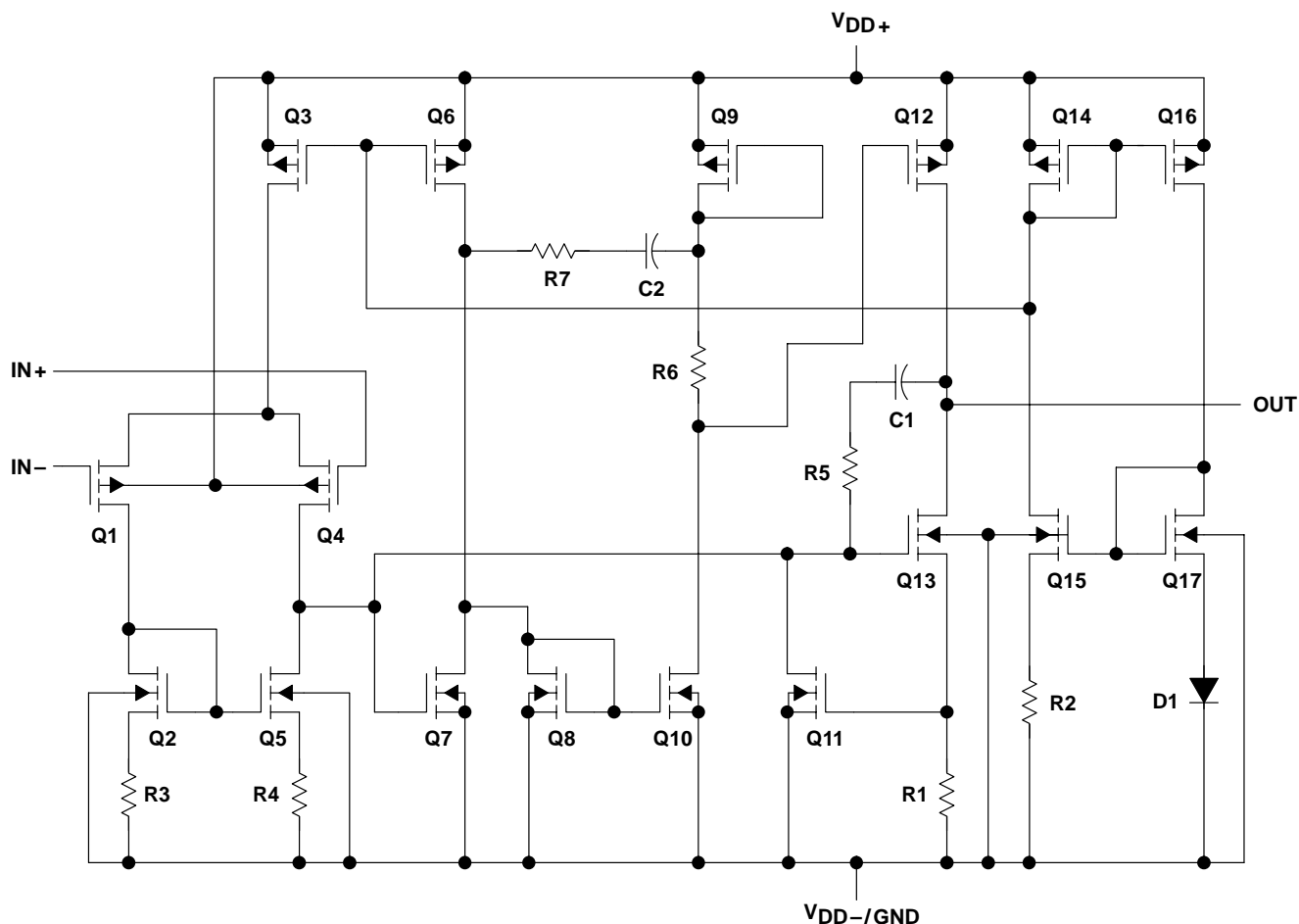

COMPONENT COUNT†	
Transistors	23
Diodes	5
Resistors	11
Capacitors	2

† Includes both amplifiers and all ESD, bias, and trim circuitry

TLV2721, TLV2721Y
Advanced LinCMOS™ RAIL-TO-RAIL
VERY LOW-POWER SINGLE OPERATIONAL AMPLIFIERS

SLOS197A – AUGUST1997 – REVISED MARCH 2001

absolute maximum ratings over operating free-air temperature range (unless otherwise noted)†

Supply voltage, V_{DD} (see Note 1)	12 V
Differential input voltage, V_{ID} (see Note 2)	$\pm V_{DD}$
Input voltage range, V_I (any input, see Note 1)	-0.3 V to V_{DD}
Input current, I_I (each input)	± 5 mA
Output current, I_O	± 50 mA
Total current into V_{DD+}	± 50 mA
Total current out of V_{DD-}	± 50 mA
Duration of short-circuit current (at or below) 25°C (see Note 3)	unlimited
Continuous total power dissipation	See Dissipation Rating Table
Operating free-air temperature range, T_A : TLV2721C	0°C to 70°C
TLV2721I	-40°C to 85°C
Storage temperature range, T_{stg}	-65°C to 150°C
Lead temperature 1,6 mm (1/16 inch) from case for 10 seconds: DBV package	260°C

† Stresses beyond those listed under “absolute maximum ratings” may cause permanent damage to the device. These are stress ratings only, and functional operation of the device at these or any other conditions beyond those indicated under “recommended operating conditions” is not implied. Exposure to absolute-maximum-rated conditions for extended periods may affect device reliability.

- NOTES: 1. All voltage values, except differential voltages, are with respect to V_{DD-} .
 2. Differential voltages are at the noninverting input with respect to the inverting input. Excessive current flows when input is brought below $V_{DD-} - 0.3$ V.
 3. The output can be shorted to either supply. Temperature and/or supply voltages must be limited to ensure that the maximum dissipation rating is not exceeded.

DISSIPATION RATING TABLE

PACKAGE	$T_A \leq 25^\circ\text{C}$ POWER RATING	DERATING FACTOR ABOVE $T_A = 25^\circ\text{C}$	$T_A = 70^\circ\text{C}$ POWER RATING	$T_A = 85^\circ\text{C}$ POWER RATING
DBV	150 mW	1.2 mW/°C	96 mW	78 mW

recommended operating conditions

	TLV2721C		TLV2721I		UNIT
	MIN	MAX	MIN	MAX	
Supply voltage, V_{DD} (see Note 1)	2.7	10	2.7	10	V
Input voltage range, V_I	V_{DD-}	$V_{DD+} - 1.3$	V_{DD-}	$V_{DD+} - 1.3$	V
Common-mode input voltage, V_{IC}	V_{DD-}	$V_{DD+} - 1.3$	V_{DD-}	$V_{DD+} - 1.3$	V
Operating free-air temperature, T_A	0	70	-40	85	°C

NOTE 1: All voltage values, except differential voltages, are with respect to V_{DD-} .



TLV2721, TLV2721Y
Advanced LinCMOS™ RAIL-TO-RAIL
VERY LOW-POWER SINGLE OPERATIONAL AMPLIFIERS

SLOS197A – AUGUST 1997 – REVISED MARCH 2001

electrical characteristics at specified free-air temperature, $V_{DD} = 3\text{ V}$ (unless otherwise noted)

PARAMETER	TEST CONDITIONS	T_A †	TLV2721C			TLV2721I			UNIT
			MIN	TYP	MAX	MIN	TYP	MAX	
V_{IO} Input offset voltage	$V_{DD\pm} = \pm 1.5\text{ V}$, $V_O = 0$, $V_{IC} = 0$, $R_S = 50\ \Omega$	Full range	0.5	3		0.5	3		mV
$\alpha_{V_{IO}}$ Temperature coefficient of input offset voltage			1		1		$\mu\text{V}/^\circ\text{C}$		
Input offset voltage long-term drift (see Note 4)		25°C	0.003		0.003		$\mu\text{V}/\text{mo}$		
I_{IO} Input offset current		25°C	0.5	60	0.5	60	pA		
		Full range		150		150			
I_{IB} Input bias current		25°C	1	60	1	60	pA		
	Full range		150		150				
V_{ICR} Common-mode input voltage range	$R_S = 50\ \Omega$, $ V_{IO} \leq 5\text{ mV}$	25°C	0 to 2	-0.3 to 2.2	0 to 2	-0.3 to 2.2	V		
		Full range	0 to 1.7		0 to 1.7				
V_{OH} High-level output voltage	$I_{OH} = -100\ \mu\text{A}$ $I_{OH} = -400\ \mu\text{A}$	25°C	2.97		2.97		V		
		25°C	2.88		2.88				
		Full range	2.6		2.6				
V_{OL} Low-level output voltage	$V_{IC} = 1.5\text{ V}$, $I_{OL} = 50\ \mu\text{A}$ $I_{OL} = 500\ \mu\text{A}$	25°C	15		15		mV		
		25°C	150		150				
		Full range	500		500				
A_{VD} Large-signal differential voltage amplification	$V_{IC} = 1.5\text{ V}$, $V_O = 1\text{ V to } 2\text{ V}$	25°C	$R_L = 2\text{ k}\Omega^\ddagger$		2 3		V/mV		
			Full range		1				
		25°C	$R_L = 1\text{ M}\Omega^\ddagger$		250				
r_{id} Differential input resistance		25°C	10^{12}		10^{12}		Ω		
r_{ic} Common-mode input resistance		25°C	10^{12}		10^{12}		Ω		
c_{ic} Common-mode input capacitance	$f = 10\text{ kHz}$	25°C	6		6		pF		
z_o Closed-loop output impedance	$f = 10\text{ kHz}$, $A_V = 10$	25°C	90		90		Ω		
CMRR Common-mode rejection ratio	$V_{IC} = 0\text{ to } 1.7\text{ V}$, $V_O = 1.5\text{ V}$, $R_S = 50\ \Omega$	25°C	70	82	70	82	dB		
		Full range	65		65				
k_{SVR} Supply voltage rejection ratio ($\Delta V_{DD} / \Delta V_{IO}$)	$V_{DD} = 2.7\text{ V to } 8\text{ V}$, $V_{IC} = V_{DD}/2$, No load	25°C	80	95	80	95	dB		
		Full range	80		80				
I_{DD} Supply current	$V_O = 1.5\text{ V}$, No load	25°C	100	150	100	150	μA		
		Full range	200		200				

† Full range for the TLV2721C is 0°C to 70°C. Full range for the TLV2721I is -40°C to 85°C.

‡ Referenced to 1.5 V

NOTE 4: Typical values are based on the input offset voltage shift observed through 500 hours of operating life test at $T_A = 150^\circ\text{C}$ extrapolated to $T_A = 25^\circ\text{C}$ using the Arrhenius equation and assuming an activation energy of 0.96 eV.



TLV2721, TLV2721Y
Advanced LinCMOS™ RAIL-TO-RAIL
VERY LOW-POWER SINGLE OPERATIONAL AMPLIFIERS

SLOS197A – AUGUST1997 – REVISED MARCH 2001

operating characteristics at specified free-air temperature, $V_{DD} = 3\text{ V}$

PARAMETER	TEST CONDITIONS		T_A †	TLV2721C			TLV2721I			UNIT	
				MIN	TYP	MAX	MIN	TYP	MAX		
SR	Slew rate at unity gain	$V_O = 1.1\text{ V to }1.9\text{ V}, R_L = 2\text{ k}\Omega^\ddagger, C_L = 100\text{ pF}^\ddagger$	25°C	0.1	0.25		0.1	0.25		V/ μs	
			Full range	0.05			0.05				
V_n	Equivalent input noise voltage		f = 10 Hz	120			120			nV/ $\sqrt{\text{Hz}}$	
			f = 1 kHz	20			20				
$V_{N(PP)}$	Peak-to-peak equivalent input noise voltage		f = 0.1 Hz to 1 Hz	680			680			mV	
			f = 0.1 Hz to 10 Hz	860			860				
I_n	Equivalent input noise current		25°C	0.6			0.6			fA/ $\sqrt{\text{Hz}}$	
THD+N	Total harmonic distortion plus noise	$V_O = 1\text{ V to }2\text{ V}, f = 20\text{ kHz}, R_L = 2\text{ k}\Omega^\ddagger$	25°C	$A_V = 1$	2.52%			2.52%			
				$A_V = 10$	7.01%			7.01%			
		$V_O = 1\text{ V to }2\text{ V}, f = 20\text{ kHz}, R_L = 2\text{ k}\Omega^\S$	25°C	$A_V = 1$	0.076%			0.076%			
				$A_V = 10$	0.147%			0.147%			
	Gain-bandwidth product	f = 1 kHz, $C_L = 100\text{ pF}^\ddagger, R_L = 2\text{ k}\Omega^\ddagger$	25°C	480			480			kHz	
BOM	Maximum output-swing bandwidth	$V_{O(PP)} = 1\text{ V}, R_L = 2\text{ k}\Omega^\ddagger, A_V = 1, C_L = 100\text{ pF}^\ddagger$	25°C	30			30			kHz	
t_s	Settling time	$A_V = -1, \text{ Step} = 1\text{ V to }2\text{ V}, R_L = 2\text{ k}\Omega^\ddagger, C_L = 100\text{ pF}^\ddagger$	To 0.1%	25°C	4.5			4.5			μs
			To 0.01%	25°C	6.8			6.8			μs
ϕ_m	Phase margin at unity gain	$R_L = 2\text{ k}\Omega^\ddagger, C_L = 100\text{ pF}^\ddagger$	25°C	53°			53°				
	Gain margin		25°C	12			12			dB	

† Full range is -40°C to 85°C .

‡ Referenced to 1.5 V

§ Referenced to 0 V



TLV2721, TLV2721Y
Advanced LinCMOS™ RAIL-TO-RAIL
VERY LOW-POWER SINGLE OPERATIONAL AMPLIFIERS
 SLOS197A – AUGUST 1997 – REVISED MARCH 2001

electrical characteristics at specified free-air temperature, $V_{DD} = 5\text{ V}$ (unless otherwise noted)

PARAMETER	TEST CONDITIONS	T_A †	TLV2721C			TLV2721I			UNIT
			MIN	TYP	MAX	MIN	TYP	MAX	
V_{IO} Input offset voltage	$V_{DD\pm} = \pm 2.5\text{ V}$, $V_O = 0$, $V_{IC} = 0$, $R_S = 50\ \Omega$	Full range	0.5		3	0.5		3	mV
$\alpha_{V_{IO}}$ Temperature coefficient of input offset voltage			1		1	$\mu\text{V}/^\circ\text{C}$			
Input offset voltage long-term drift (see Note 4)		25°C	0.003		0.003	$\mu\text{V}/\text{mo}$			
I_{IO} Input offset current		25°C	0.5		60	0.5		60	pA
		Full range		150		150			
I_{IB} Input bias current		25°C	1		60	1		60	pA
	Full range		150		150				
V_{ICR} Common-mode input voltage range	$R_S = 50\ \Omega$, $ V_{IO} \leq 5\text{ mV}$	25°C	0 to 4	-0.3 to 4.2	0 to 4	-0.3 to 4.2	V		
		Full range	0 to 3.5		0 to 3.5				
V_{OH} High-level output voltage	$I_{OH} = -500\ \mu\text{A}$	25°C	4.75	4.88	4.75	4.88	V		
	$I_{OH} = -1\text{ mA}$		4.6	4.76	4.6	4.76			
V_{OL} Low-level output voltage	$V_{IC} = 2.5\text{ V}$, $I_{OL} = 50\ \mu\text{A}$	25°C		12		12	mV		
	$V_{IC} = 2.5\text{ V}$, $I_{OL} = 500\ \mu\text{A}$	25°C		120		120			
	Full range		500		500				
A_{VD} Large-signal differential voltage amplification	$V_{IC} = 2.5\text{ V}$, $V_O = 1\text{ V to } 4\text{ V}$	$R_L = 2\text{ k}\Omega$ ‡	25°C	3	5	3	5	V/mV	
		$R_L = 1\text{ M}\Omega$ ‡	Full range	1		1			
			25°C		800		800		
r_{id} Differential input resistance		25°C		10^{12}		10^{12}	Ω		
r_{ic} Common-mode input resistance		25°C		10^{12}		10^{12}	Ω		
C_{ic} Common-mode input capacitance	$f = 10\text{ kHz}$	25°C		6		6	pF		
z_o Closed-loop output impedance	$f = 10\text{ kHz}$, $A_V = 10$	25°C		70		70	Ω		
CMRR Common-mode rejection ratio	$V_{IC} = 0\text{ to } 2.7\text{ V}$, $V_O = 1.5\text{ V}$, $R_S = 50\ \Omega$	25°C	70	85	70	85	dB		
		Full range	65		65				
k_{SVR} Supply voltage rejection ratio ($\Delta V_{DD} / \Delta V_{IO}$)	$V_{DD} = 4.4\text{ V to } 8\text{ V}$, $V_{IC} = V_{DD}/2$, No load	25°C	80	95	80	95	dB		
		Full range	80		80				
I_{DD} Supply current	$V_O = 2.5\text{ V}$, No load	25°C	110	150	110	150	μA		
		Full range		200		200			

† Full range for the TLV2721C is 0°C to 70°C. Full range for the TLV2721I is -40°C to 85°C.

‡ Referenced to 2.5 V

NOTE 5: Typical values are based on the input offset voltage shift observed through 500 hours of operating life test at $T_A = 150^\circ\text{C}$ extrapolated to $T_A = 25^\circ\text{C}$ using the Arrhenius equation and assuming an activation energy of 0.96 eV.

TLV2721, TLV2721Y
Advanced LinCMOS™ RAIL-TO-RAIL
VERY LOW-POWER SINGLE OPERATIONAL AMPLIFIERS

SLOS197A – AUGUST 1997 – REVISED MARCH 2001

operating characteristics at specified free-air temperature, $V_{DD} = 5\text{ V}$

PARAMETER	TEST CONDITIONS	T_A †	TLV2721C			TLV2721I			UNIT	
			MIN	TYP	MAX	MIN	TYP	MAX		
SR	Slew rate at unity gain $V_O = 1.5\text{ V to }3.5\text{ V}, R_L = 2\text{ k}\Omega^\ddagger, C_L = 100\text{ pF}^\ddagger$	25°C	0.1	0.25		0.1	0.25		V/ μ s	
		Full range	0.05			0.05				
V_n	Equivalent input noise voltage $f = 10\text{ Hz}$ $f = 1\text{ kHz}$	25°C	90			90			nV/ $\sqrt{\text{Hz}}$	
		25°C	19			19				
$V_{N(PP)}$	Peak-to-peak equivalent input noise voltage $f = 0.1\text{ Hz to }1\text{ Hz}$ $f = 0.1\text{ Hz to }10\text{ Hz}$	25°C	800			800			mV	
		25°C	960			960				
I_n	Equivalent input noise current	25°C	0.6			0.6			fA/ $\sqrt{\text{Hz}}$	
THD+N	Total harmonic distortion plus noise $V_O = 1.5\text{ V to }3.5\text{ V}, f = 20\text{ kHz}, R_L = 2\text{ k}\Omega^\ddagger$	25°C	$A_V = 1$	2.45%			2.45%			
			$A_V = 10$	5.54%			5.54%			
	25°C	$V_O = 1.5\text{ V to }3.5\text{ V}, f = 20\text{ kHz}, R_L = 2\text{ k}\Omega^\S$	$A_V = 1$	0.142%			0.142%			
		$A_V = 10$	0.257%			0.257%				
Gain-bandwidth product	$f = 1\text{ kHz}, C_L = 100\text{ pF}^\ddagger, R_L = 2\text{ k}\Omega^\ddagger$	25°C	510			510			kHz	
B_{OM}	Maximum output-swing bandwidth $V_{O(PP)} = 1\text{ V}, R_L = 2\text{ k}\Omega^\ddagger, A_V = 1, C_L = 100\text{ pF}^\ddagger$	25°C	40			40			kHz	
t_s	Settling time $A_V = -1, \text{ Step} = 1.5\text{ V to }3.5\text{ V}, R_L = 2\text{ k}\Omega^\ddagger, C_L = 100\text{ pF}^\ddagger$	25°C	6.8			6.8			μ s	
		25°C	9.2			9.2				
ϕ_m	Phase margin at unity gain $R_L = 2\text{ k}\Omega^\ddagger, C_L = 100\text{ pF}^\ddagger$	25°C	53°			53°				
		25°C	12			12				
	Gain margin	25°C	12			12			dB	

† Full range is $-40^\circ\text{C to }85^\circ\text{C}$.

‡ Referenced to 2.5 V

§ Referenced to 0 V



TLV2721, TLV2721Y
Advanced LinCMOS™ RAIL-TO-RAIL
VERY LOW-POWER SINGLE OPERATIONAL AMPLIFIERS
 SLOS197A – AUGUST 1997 – REVISED MARCH 2001

electrical characteristics at $V_{DD} = 3\text{ V}$, $T_A = 25^\circ\text{C}$ (unless otherwise noted)

PARAMETER	TEST CONDITIONS	TLV2721Y			UNIT
		MIN	TYP	MAX	
V_{IO} Input offset voltage	$V_{DD} \pm \pm 1.5\text{ V}$, $R_S = 50\ \Omega$	$V_{IC} = 0$, $V_O = 0$,	620		μV
I_{IO} Input offset current			0.5	60	pA
I_{IB} Input bias current			1	60	pA
V_{ICR} Common-mode input voltage range	$ V_{IO} \leq 5\text{ mV}$, $R_S = 50\ \Omega$	-0.3 to 2.2			V
V_{OH} High-level output voltage	$I_{OH} = -100\ \mu\text{A}$	2.97			V
V_{OL} Low-level output voltage	$V_{IC} = 1.5\text{ V}$, $I_{OL} = 50\ \mu\text{A}$	15			mV
	$V_{IC} = 1.5\text{ V}$, $I_{OL} = 500\ \mu\text{A}$	150			
A_{VD} Large-signal differential voltage amplification	$V_O = 1\text{ V to } 2\text{ V}$	$R_L = 2\text{ k}\Omega^\dagger$	3		V/mV
		$R_L = 1\text{ M}\Omega^\dagger$	250		
r_{id} Differential input resistance		10^{12}			Ω
r_{ic} Common-mode input resistance		10^{12}			Ω
c_{ic} Common-mode input capacitance	$f = 10\text{ kHz}$	6			pF
z_o Closed-loop output impedance	$f = 10\text{ kHz}$, $A_V = 10$	90			Ω
CMRR Common-mode rejection ratio	$V_{IC} = 0\text{ to } 1.7\text{ V}$, $V_O = 0$, $R_S = 50\ \Omega$	82			dB
k_{SVR} Supply voltage rejection ratio ($\Delta V_{DD}/\Delta V_{IO}$)	$V_{DD} = 2.7\text{ V to } 8\text{ V}$, $V_{IC} = 0$, No load	95			dB
I_{DD} Supply current	$V_O = 0$, No load	100			μA

† Referenced to 1.5 V

electrical characteristics at $V_{DD} = 5\text{ V}$, $T_A = 25^\circ\text{C}$ (unless otherwise noted)

PARAMETER	TEST CONDITIONS	TLV2721Y			UNIT
		MIN	TYP	MAX	
V_{IO} Input offset voltage	$V_{DD} \pm \pm 1.5\text{ V}$, $R_S = 50\ \Omega$	$V_{IC} = 0$, $V_O = 0$,	610		μV
I_{IO} Input offset current			0.5	60	pA
I_{IB} Input bias current			1	60	pA
V_{ICR} Common-mode input voltage range	$ V_{IO} \leq 5\text{ mV}$, $R_S = 50\ \Omega$	-0.3 to 4.2			V
V_{OH} High-level output voltage	$I_{OH} = -500\ \mu\text{A}$	4.88			V
V_{OL} Low-level output voltage	$V_{IC} = 2.5\text{ V}$, $I_{OL} = 50\ \mu\text{A}$	12			mV
	$V_{IC} = 2.5\text{ V}$, $I_{OL} = 500\ \mu\text{A}$	120			
A_{VD} Large-signal differential voltage amplification	$V_O = 1\text{ V to } 4\text{ V}$	$R_L = 2\text{ k}\Omega^\dagger$	5		V/mV
		$R_L = 1\text{ M}\Omega^\dagger$	800		
r_{id} Differential input resistance		10^{12}			Ω
r_{ic} Common-mode input resistance		10^{12}			Ω
c_{ic} Common-mode input capacitance	$f = 10\text{ kHz}$	6			pF
z_o Closed-loop output impedance	$f = 10\text{ kHz}$, $A_V = 10$	70			Ω
CMRR Common-mode rejection ratio	$V_{IC} = 0\text{ to } 1.7\text{ V}$, $V_O = 0$, $R_S = 50\ \Omega$	85			dB
k_{SVR} Supply voltage rejection ratio ($\Delta V_{DD}/\Delta V_{IO}$)	$V_{DD} = 2.7\text{ V to } 8\text{ V}$, $V_{IC} = 0$, No load	95			dB
I_{DD} Supply current	$V_O = 0$, No load	110			μA

† Referenced to 2.5 V



TLV2721, TLV2721Y
Advanced LinCMOS™ RAIL-TO-RAIL
VERY LOW-POWER SINGLE OPERATIONAL AMPLIFIERS
 SLOS197A – AUGUST1997 – REVISED MARCH 2001

TYPICAL CHARACTERISTICS

Table of Graphs

		FIGURE
V_{IO}	Input offset voltage	Distribution vs Common-mode input voltage 1, 2 3, 4
αV_{IO}	Input offset voltage temperature coefficient	Distribution 5, 6
I_{IB}/I_{IO}	Input bias and input offset currents	vs Free-air temperature 7
V_I	Input voltage	vs Supply voltage vs Free-air temperature 8 9
V_{OH}	High-level output voltage	vs High-level output current 10, 13
V_{OL}	Low-level output voltage	vs Low-level output current 11, 12, 14
$V_{O(PP)}$	Maximum peak-to-peak output voltage	vs Frequency 15
I_{OS}	Short-circuit output current	vs Supply voltage vs Free-air temperature 16 17
V_O	Output voltage	vs Differential input voltage 18, 19
A_{VD}	Differential voltage amplification	vs Load resistance 20
A_{VD}	Large signal differential voltage amplification	vs Frequency vs Free-air temperature 21, 22 23, 24
Z_o	Output impedance	vs Frequency 25, 26
CMRR	Common-mode rejection ratio	vs Frequency vs Free-air temperature 27 28
kSVR	Supply-voltage rejection ratio	vs Frequency vs Free-air temperature 29, 30 31
I_{DD}	Supply current	vs Supply voltage 32
SR	Slew rate	vs Load capacitance vs Free-air temperature 33 34
V_O	Inverting large-signal pulse response	35, 36
V_O	Voltage-follower large-signal pulse response	37, 38
V_O	Inverting small-signal pulse response	39, 40
V_O	Voltage-follower small-signal pulse response	41, 42
V_n	Equivalent input noise voltage	vs Frequency 43, 44
	Input noise voltage (referred to input)	Over a 10-second period 45
THD + N	Total harmonic distortion plus noise	vs Frequency 46
	Gain-bandwidth product	vs Free-air temperature vs Supply voltage 47 48
ϕ_m	Phase margin	vs Frequency vs Load capacitance 21, 22 51, 52
	Gain margin	vs Load capacitance 49, 50
B_1	Unity-gain bandwidth	vs Load capacitance 53, 54



TYPICAL CHARACTERISTICS

**DISTRIBUTION OF TLV2721
INPUT OFFSET VOLTAGE**

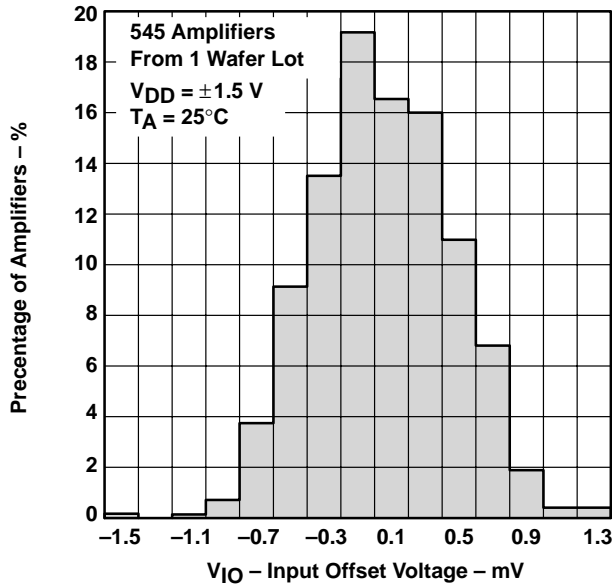

Figure 1

**DISTRIBUTION OF TLV2721
INPUT OFFSET VOLTAGE**

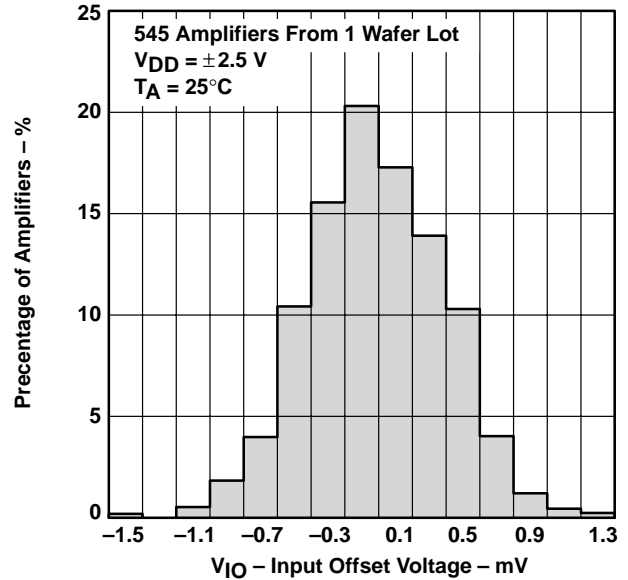

Figure 2

**INPUT OFFSET VOLTAGE†
vs
COMMON-MODE INPUT VOLTAGE**

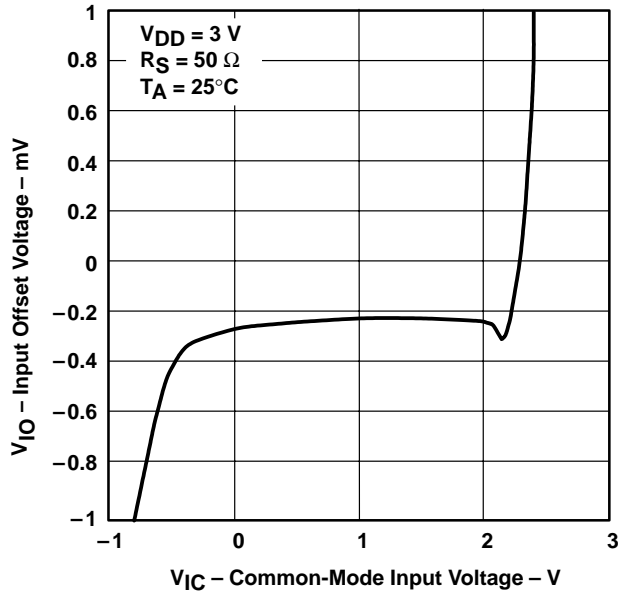

Figure 3

**INPUT OFFSET VOLTAGE†
vs
COMMON-MODE INPUT VOLTAGE**

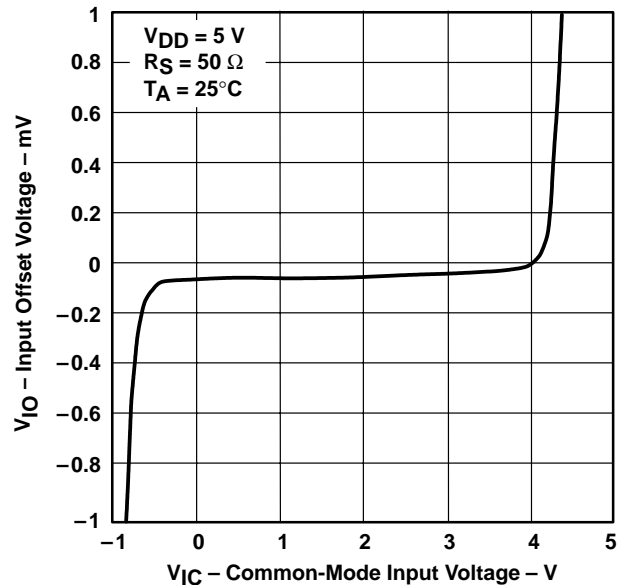

Figure 4

† For all curves where $V_{DD} = 5\text{ V}$, all loads are referenced to 2.5 V. For all curves where $V_{DD} = 3\text{ V}$, all loads are referenced to 1.5 V.

TLV2721, TLV2721Y
Advanced LinCMOS™ RAIL-TO-RAIL
VERY LOW-POWER SINGLE OPERATIONAL AMPLIFIERS

SLOS197A – AUGUST 1997 – REVISED MARCH 2001

TYPICAL CHARACTERISTICS

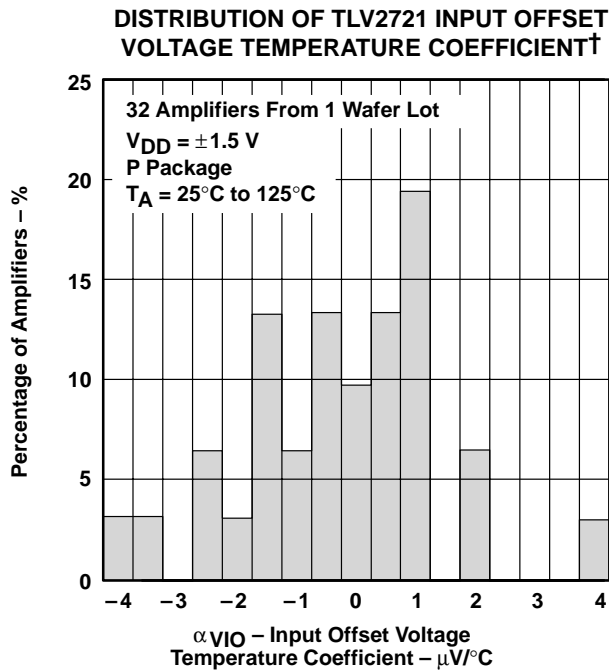

Figure 5

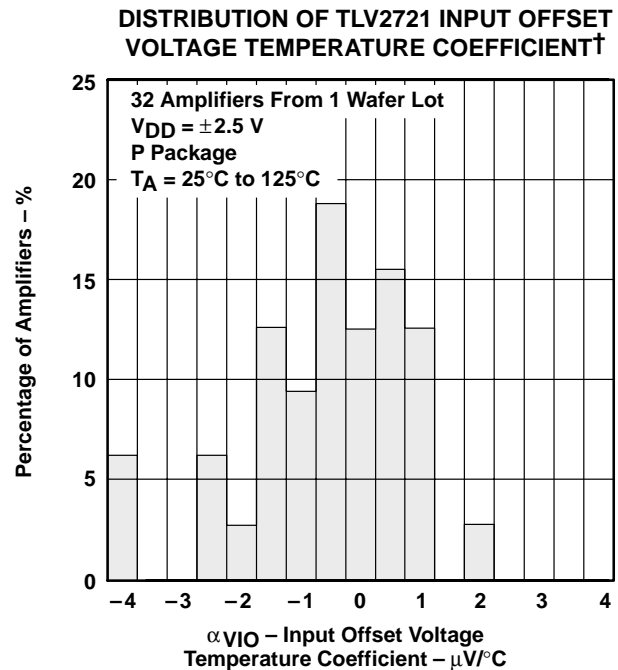

Figure 6

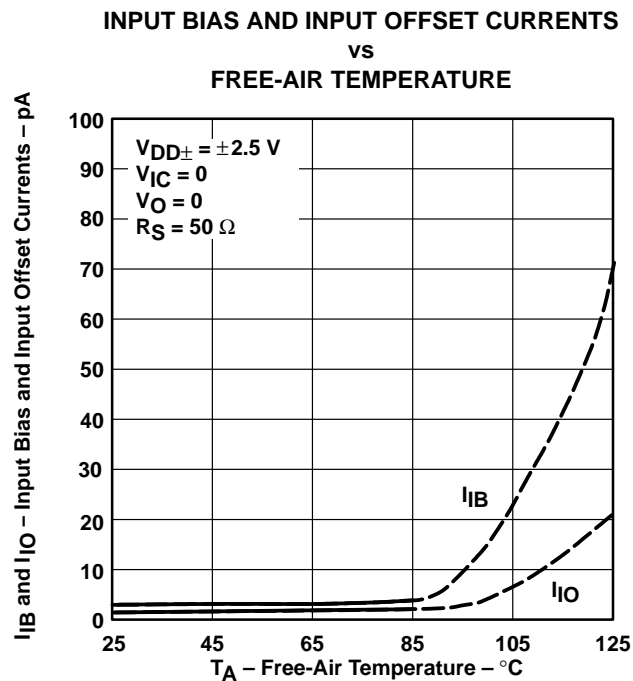

Figure 7

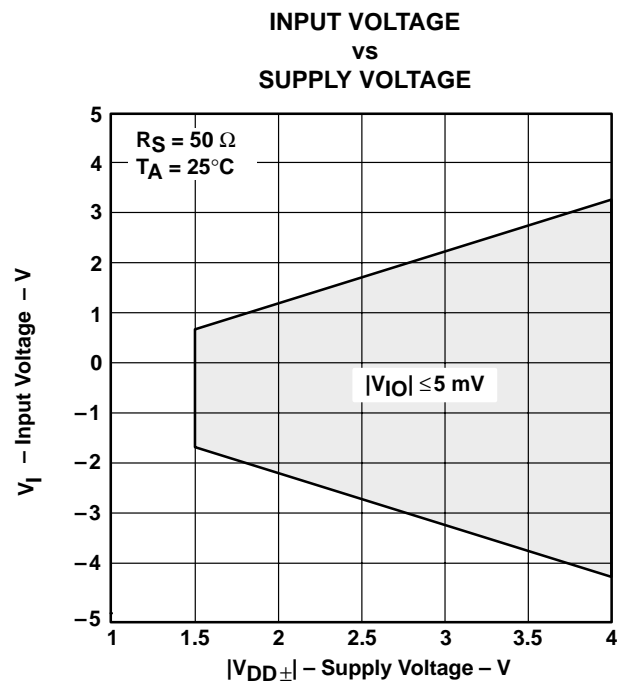

Figure 8

† Data at high and low temperatures are applicable only within the rated operating free-air temperature ranges of the various devices.



TYPICAL CHARACTERISTICS

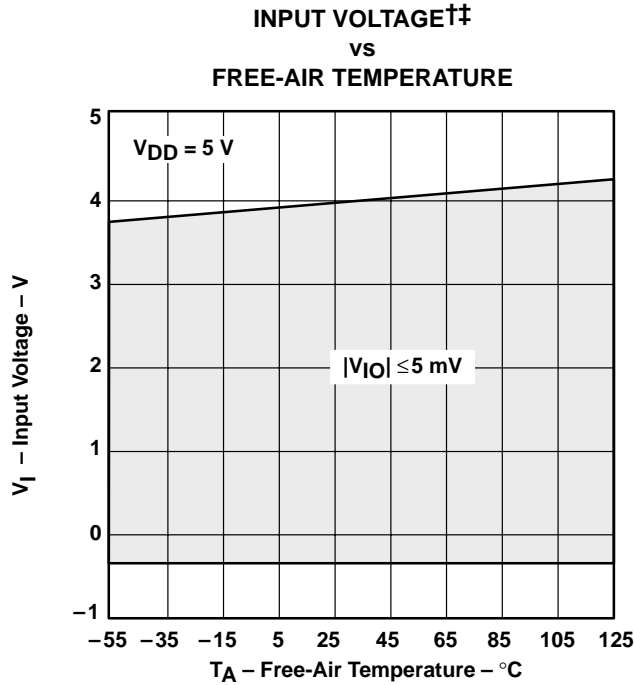

Figure 9

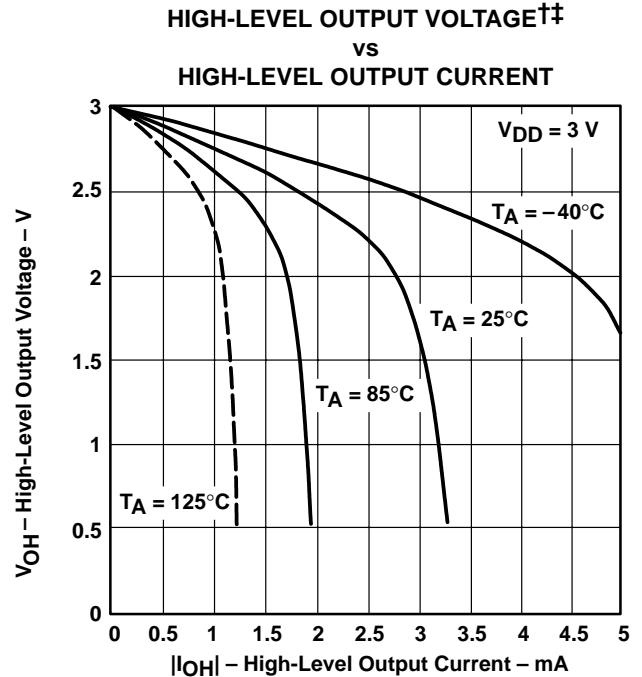

Figure 10

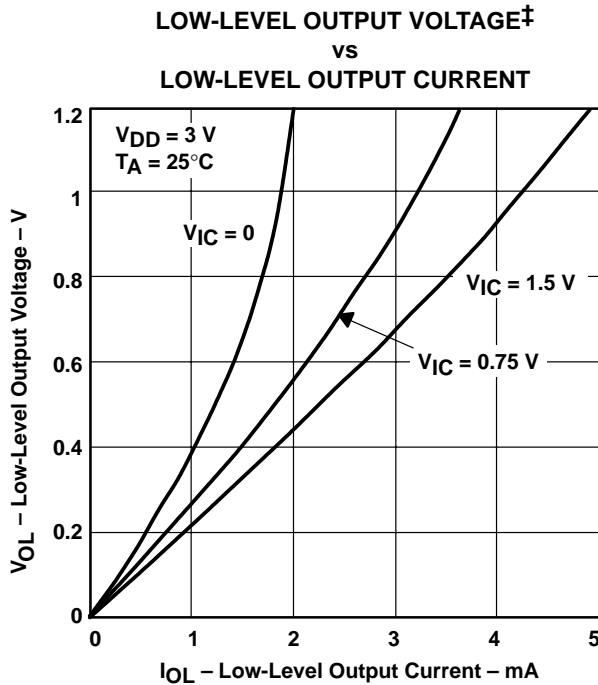

Figure 11

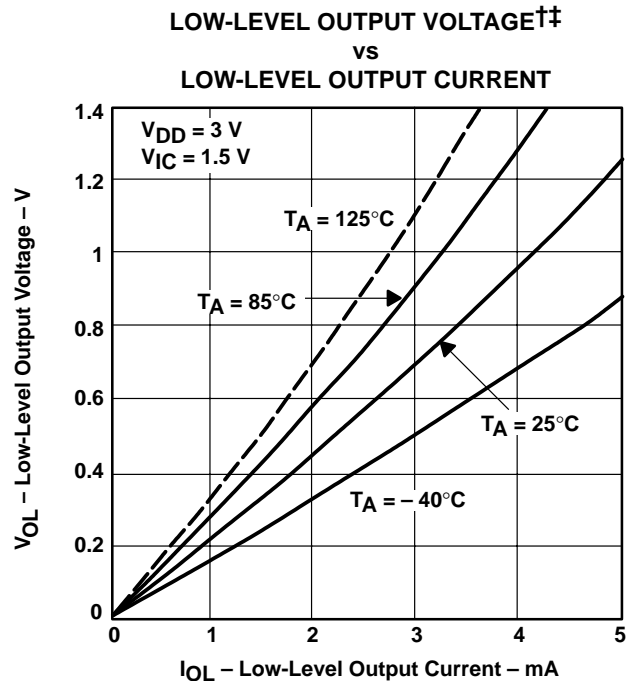

Figure 12

† Data at high and low temperatures are applicable only within the rated operating free-air temperature ranges of the various devices.
 †† For all curves where $V_{DD} = 5\text{ V}$, all loads are referenced to 2.5 V. For all curves where $V_{DD} = 3\text{ V}$, all loads are referenced to 1.5 V.

TYPICAL CHARACTERISTICS

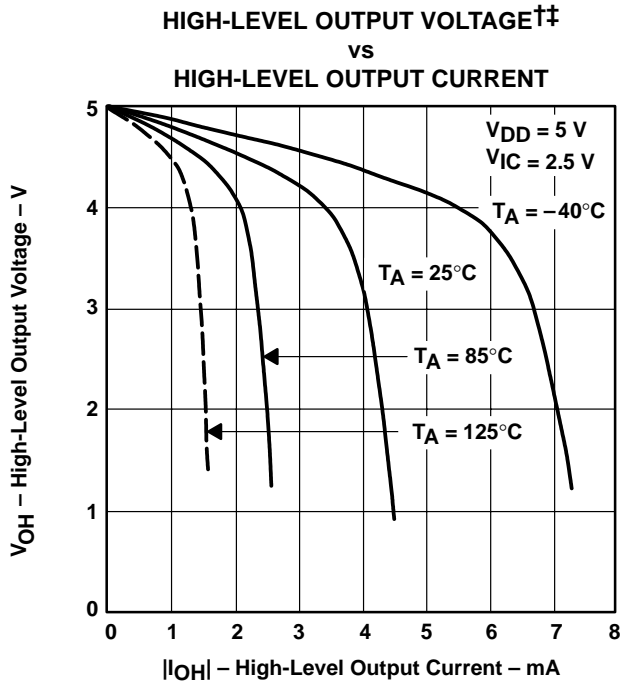

Figure 13

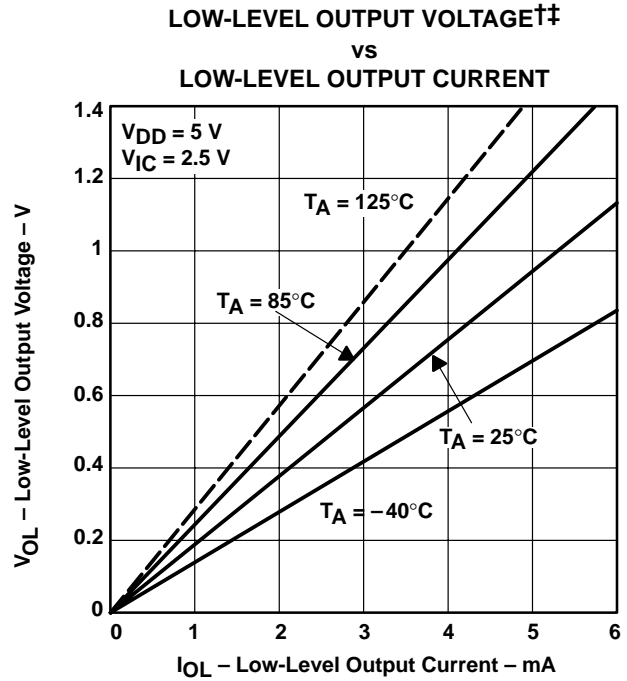

Figure 14

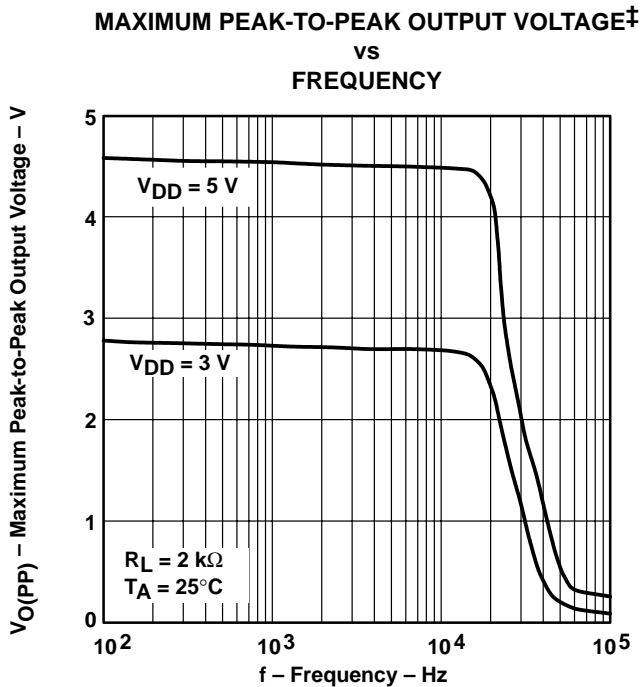

Figure 15

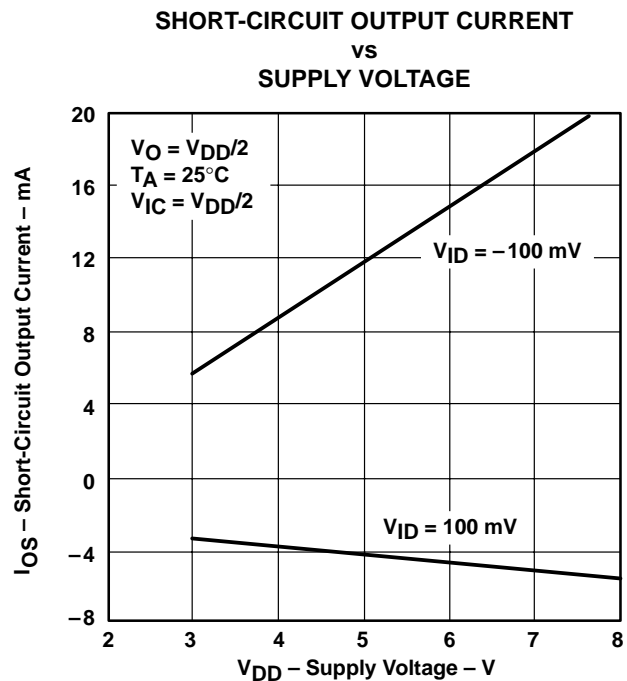
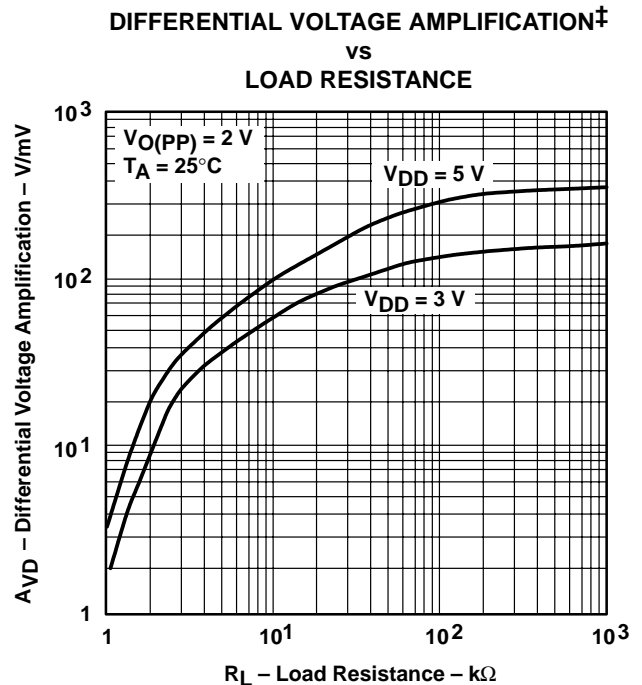
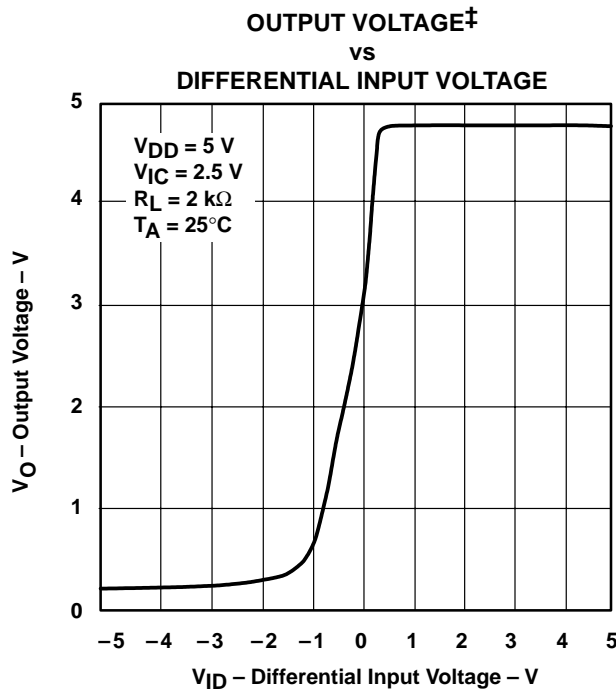
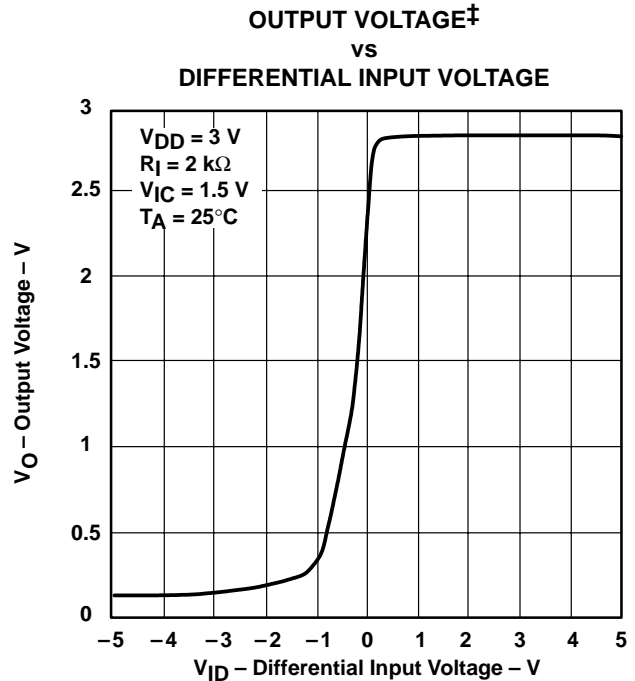
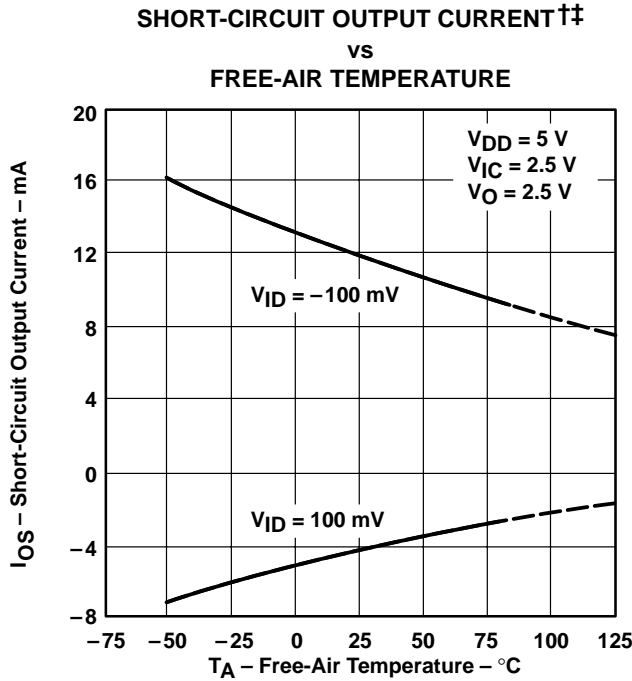

Figure 16

† Data at high and low temperatures are applicable only within the rated operating free-air temperature ranges of the various devices.
 ‡ For all curves where $V_{DD} = 5\text{ V}$, all loads are referenced to 2.5 V. For all curves where $V_{DD} = 3\text{ V}$, all loads are referenced to 1.5 V.

TYPICAL CHARACTERISTICS



† Data at high and low temperatures are applicable only within the rated operating free-air temperature ranges of the various devices.
 †† For all curves where $V_{DD} = 5\text{ V}$, all loads are referenced to 2.5 V. For all curves where $V_{DD} = 3\text{ V}$, all loads are referenced to 1.5 V.

TYPICAL CHARACTERISTICS

LARGE-SIGNAL DIFFERENTIAL VOLTAGE†
 AMPLIFICATION AND PHASE MARGIN
 VS
 FREQUENCY

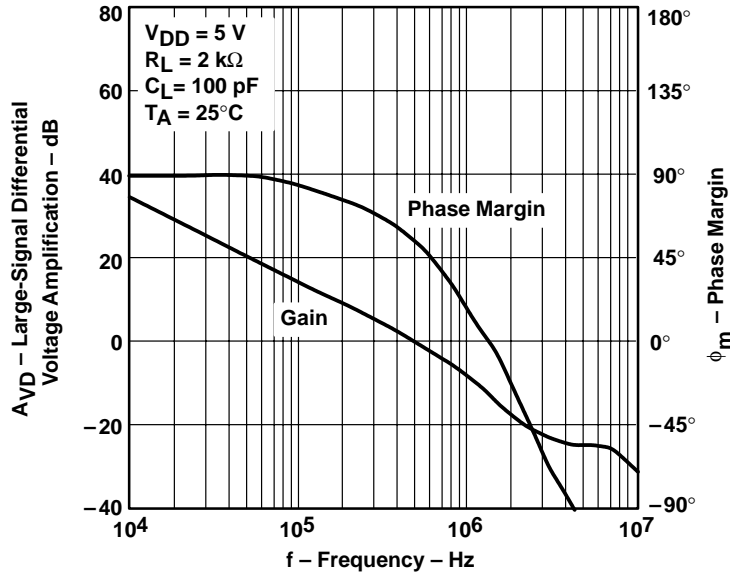

Figure 21

LARGE-SIGNAL DIFFERENTIAL VOLTAGE
 AMPLIFICATION AND PHASE MARGIN†
 VS
 FREQUENCY

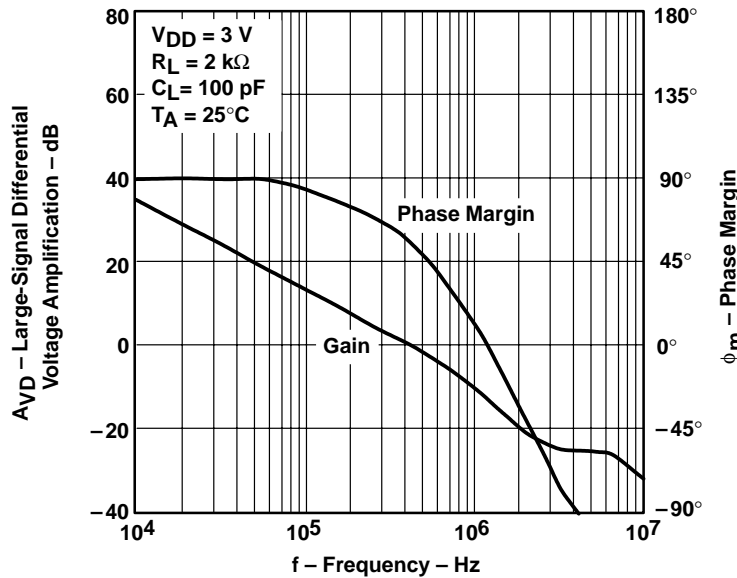
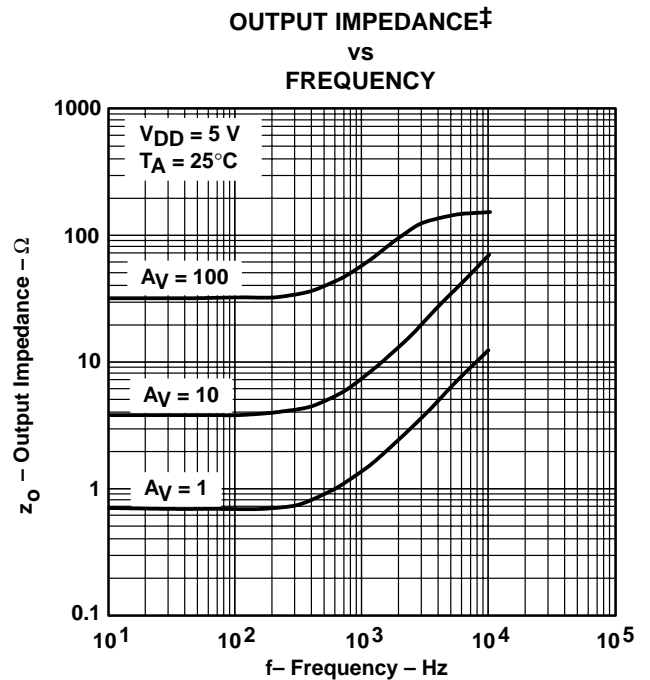
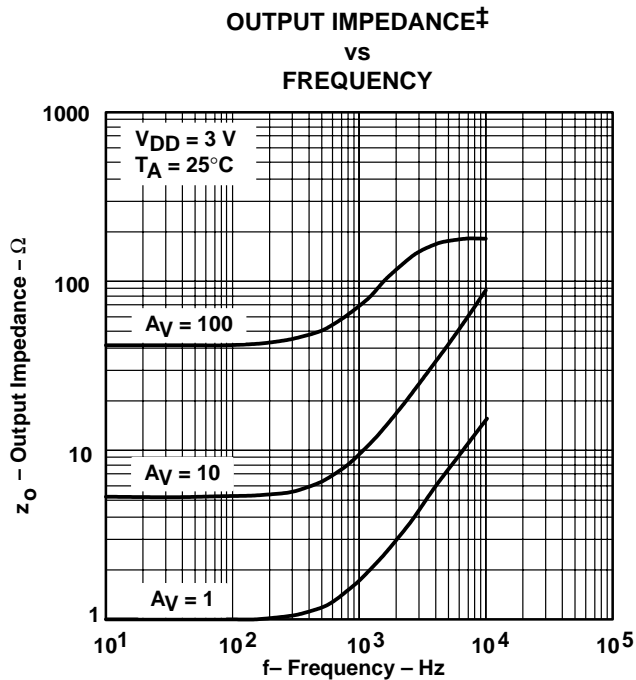
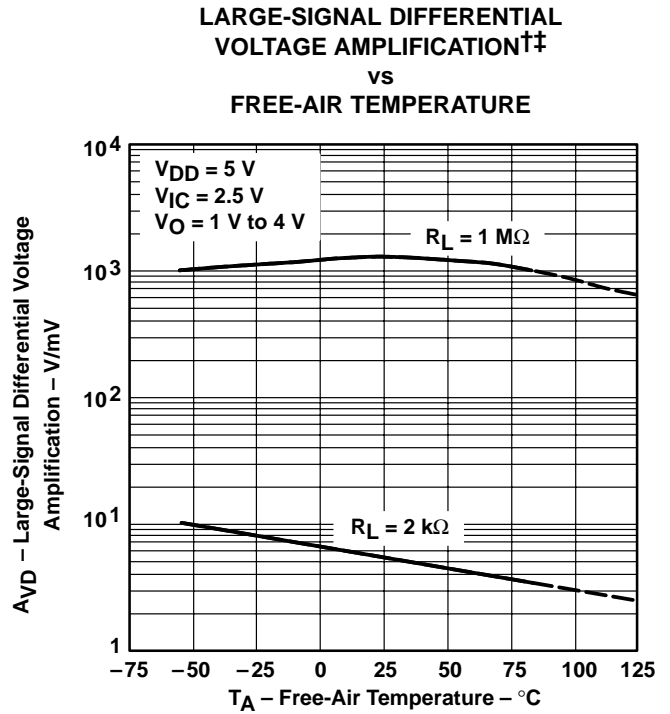
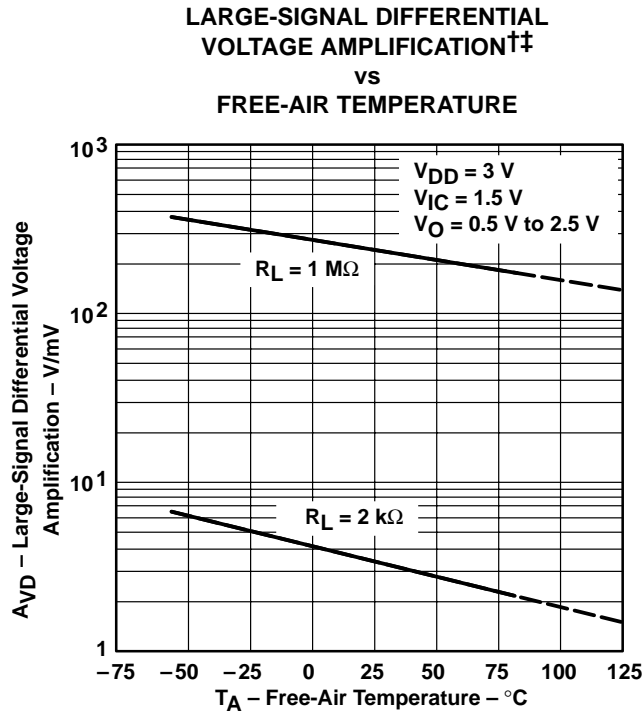

Figure 22

† For all curves where $V_{DD} = 5\text{ V}$, all loads are referenced to 2.5 V. For all curves where $V_{DD} = 3\text{ V}$, all loads are referenced to 1.5 V.

TYPICAL CHARACTERISTICS



† Data at high and low temperatures are applicable only within the rated operating free-air temperature ranges of the various devices.
 ‡ For all curves where $V_{DD} = 5\text{ V}$, all loads are referenced to 2.5 V. For all curves where $V_{DD} = 3\text{ V}$, all loads are referenced to 1.5 V.

TYPICAL CHARACTERISTICS

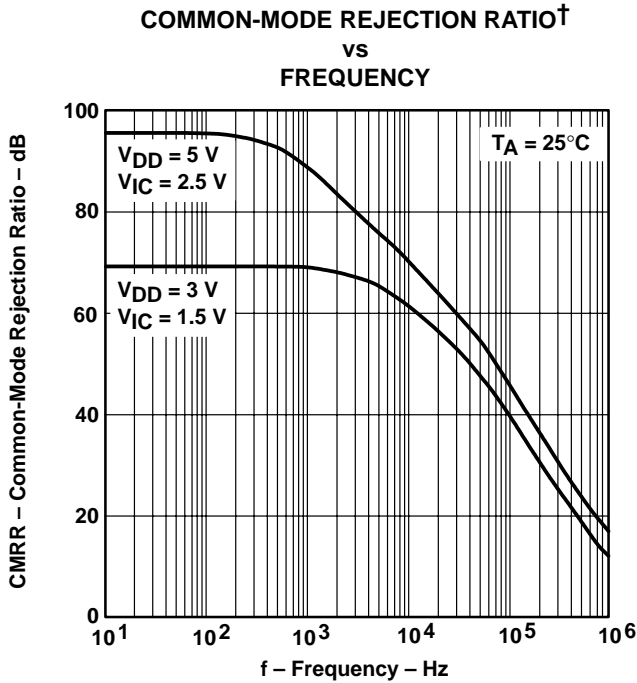

Figure 27

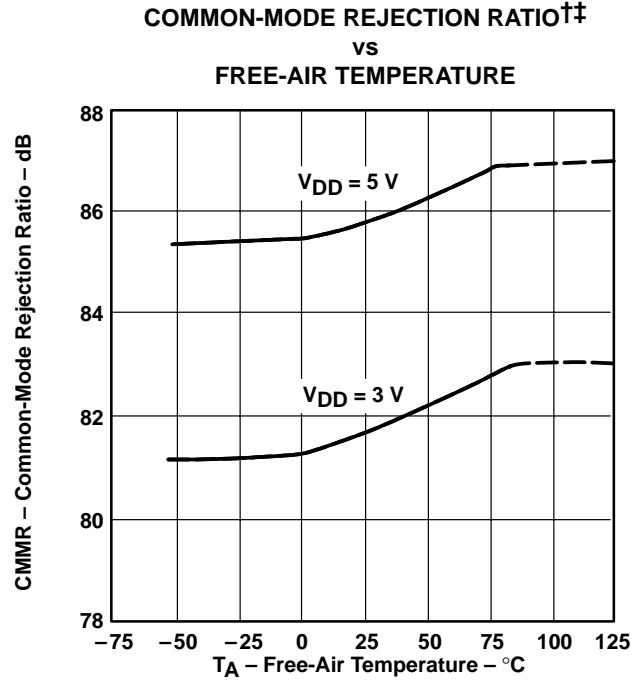

Figure 28

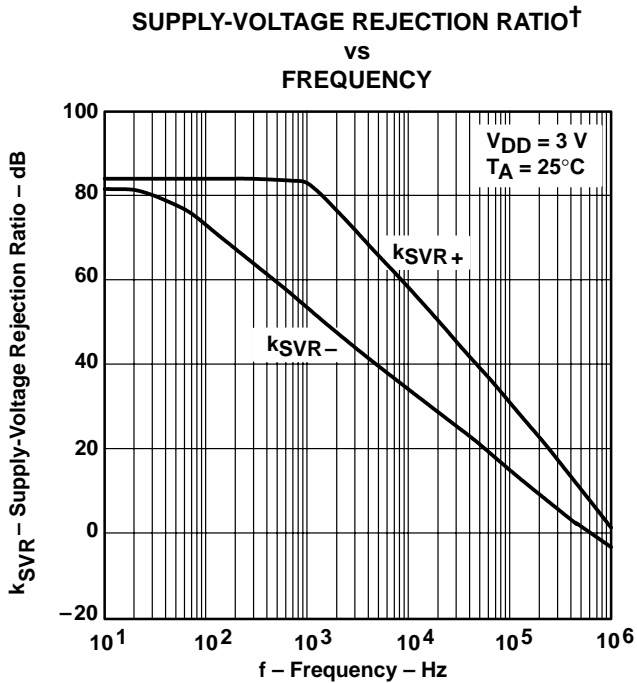

Figure 29

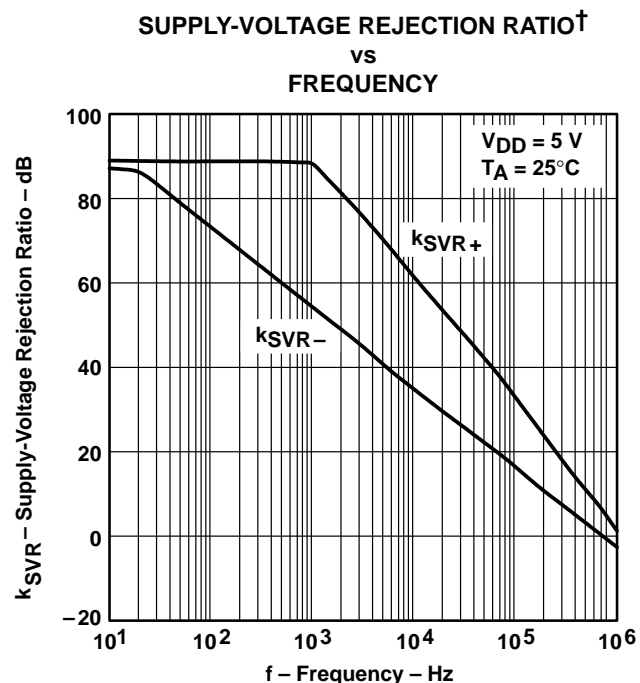
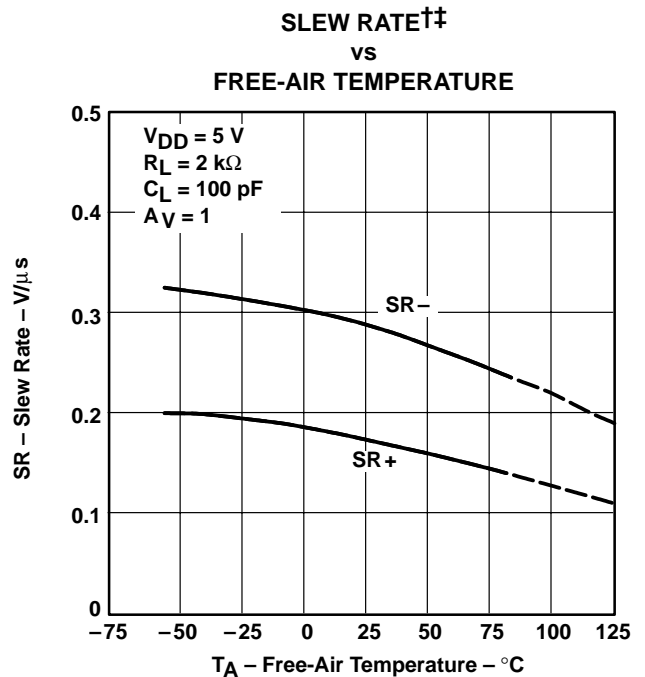
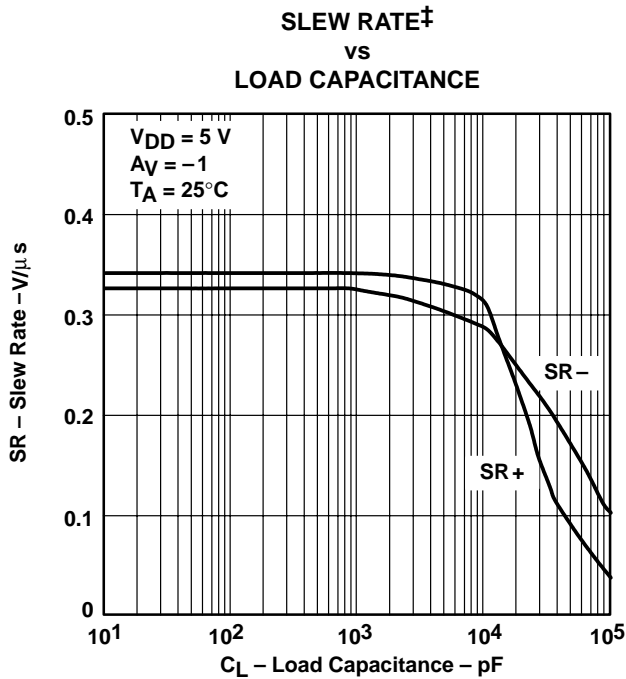
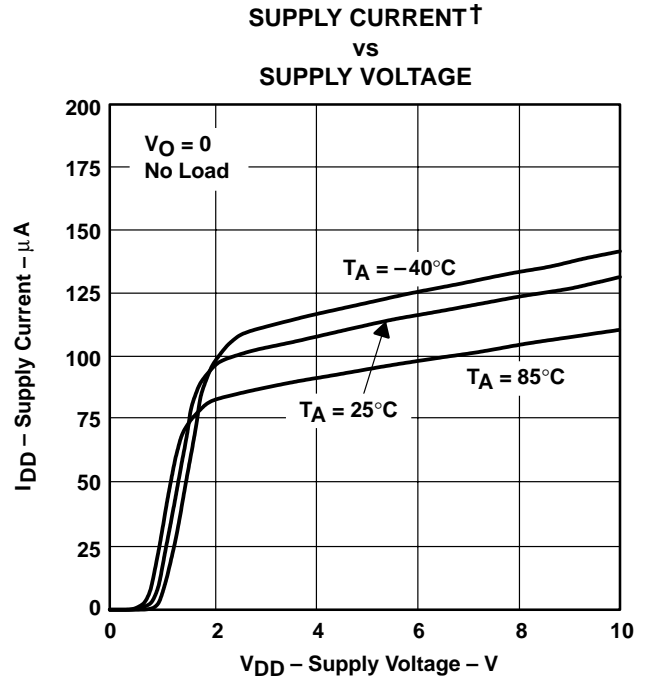
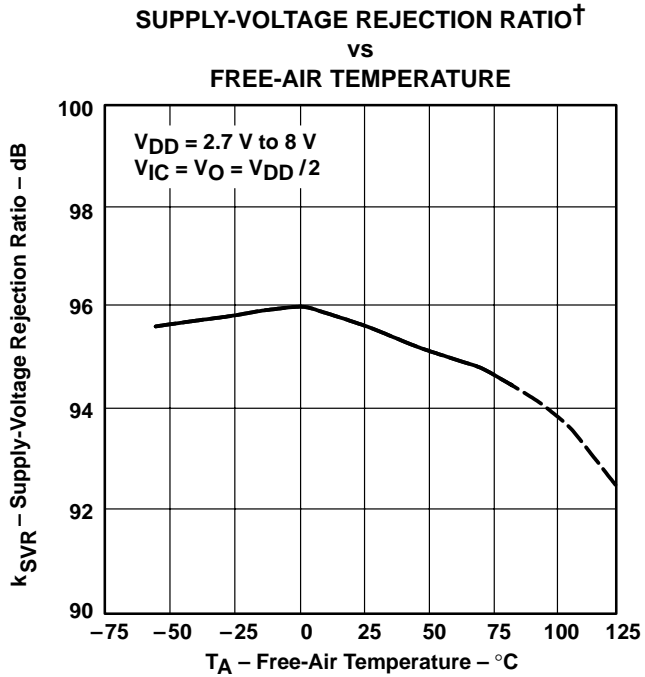

Figure 30

† For all curves where $V_{DD} = 5\text{ V}$, all loads are referenced to 2.5 V. For all curves where $V_{DD} = 3\text{ V}$, all loads are referenced to 1.5 V.
 ‡ Data at high and low temperatures are applicable only within the rated operating free-air temperature ranges of the various devices.

TYPICAL CHARACTERISTICS



† Data at high and low temperatures are applicable only within the rated operating free-air temperature ranges of the various devices.

‡ For all curves where $V_{DD} = 5\text{ V}$, all loads are referenced to 2.5 V. For all curves where $V_{DD} = 3\text{ V}$, all loads are referenced to 1.5 V.

TYPICAL CHARACTERISTICS

INVERTING LARGE-SIGNAL PULSE RESPONSE†

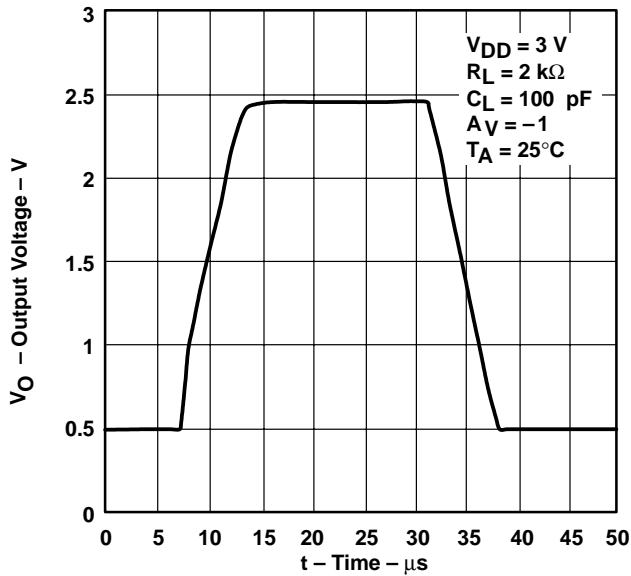

Figure 35

INVERTING LARGE-SIGNAL PULSE RESPONSE†

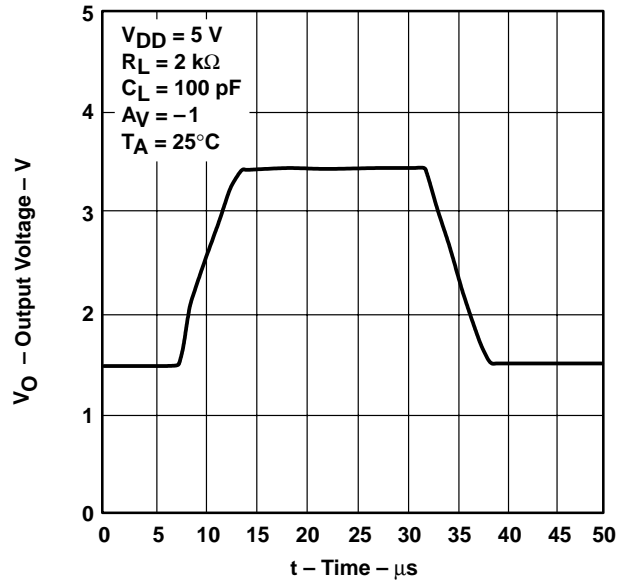

Figure 36

VOLTAGE-FOLLOWER LARGE-SIGNAL PULSE RESPONSE†

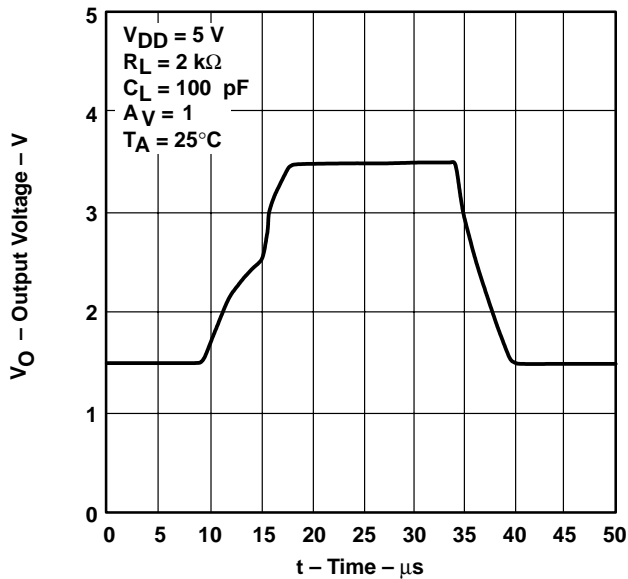

Figure 37

VOLTAGE-FOLLOWER LARGE-SIGNAL PULSE RESPONSE†

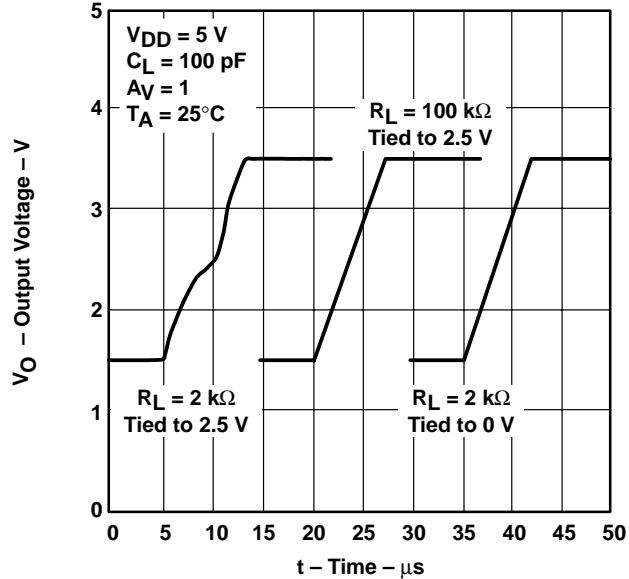

Figure 38

† For all curves where $V_{DD} = 5\text{ V}$, all loads are referenced to 2.5 V. For all curves where $V_{DD} = 3\text{ V}$, all loads are referenced to 1.5 V.

TYPICAL CHARACTERISTICS

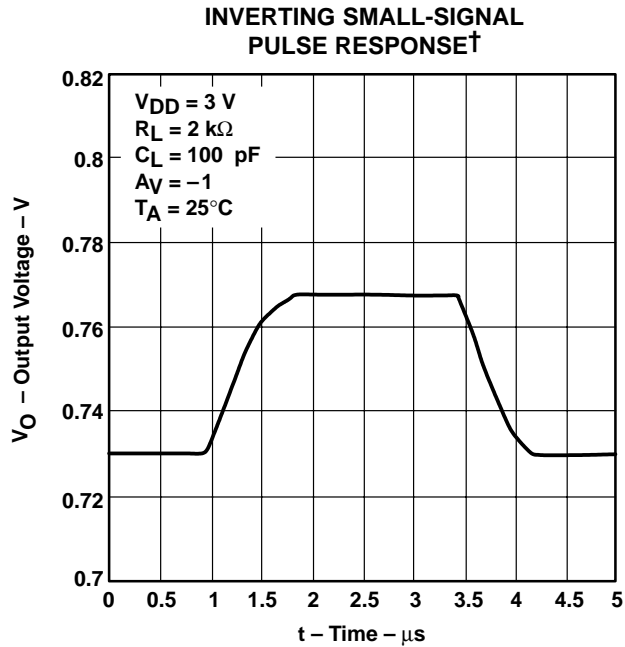

Figure 39

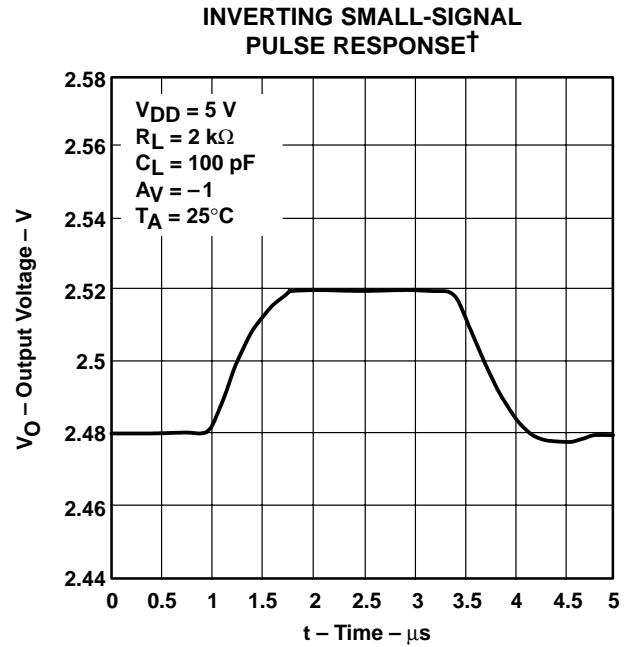

Figure 40

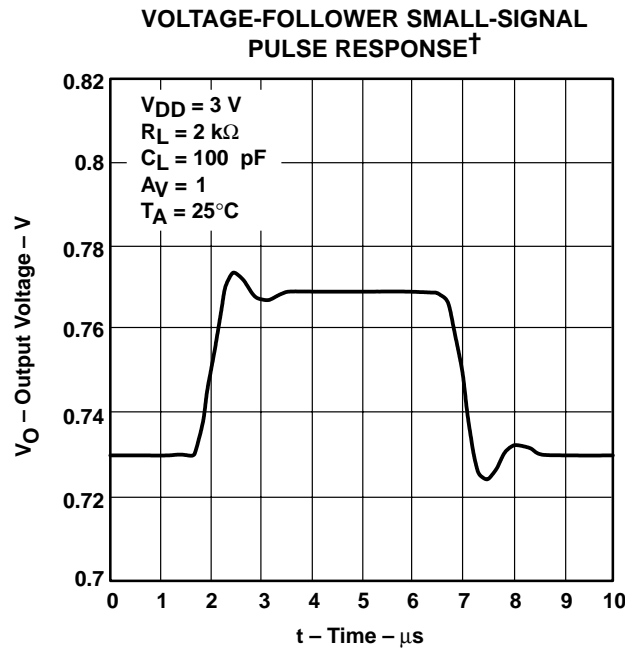

Figure 41

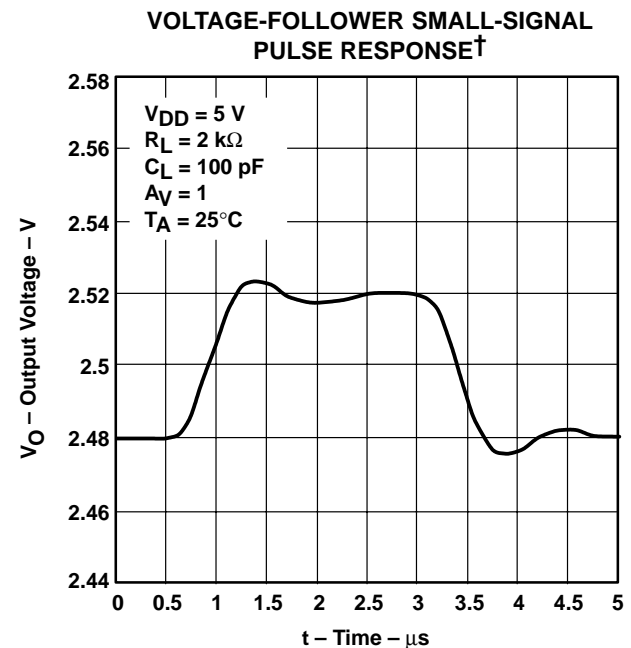

Figure 42

† For all curves where $V_{DD} = 5\text{ V}$, all loads are referenced to 2.5 V. For all curves where $V_{DD} = 3\text{ V}$, all loads are referenced to 1.5 V.

TYPICAL CHARACTERISTICS

EQUIVALENT INPUT NOISE VOLTAGE†
 vs
 FREQUENCY

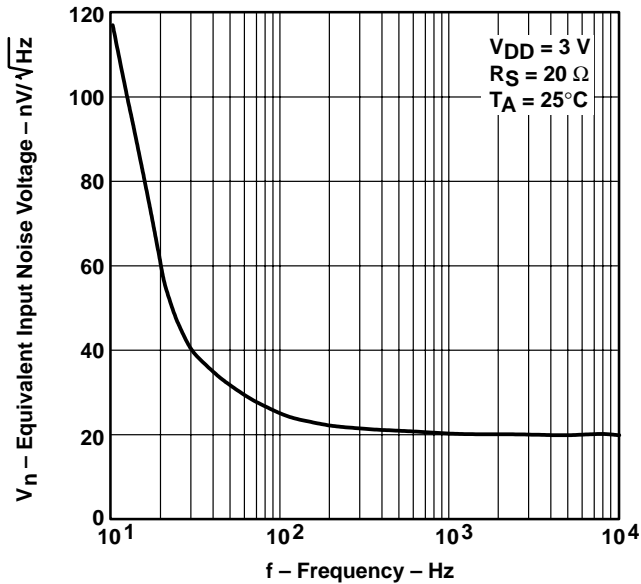

Figure 43

EQUIVALENT INPUT NOISE VOLTAGE†
 vs
 FREQUENCY

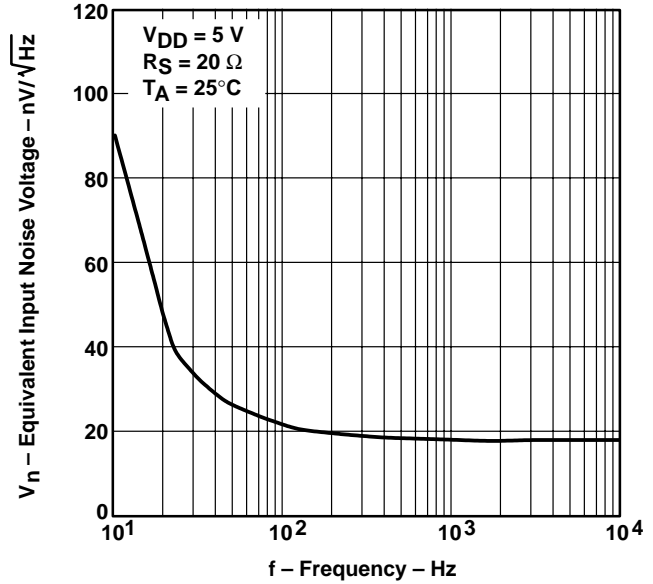

Figure 44

INPUT NOISE VOLTAGE OVER
 A 10-SECOND PERIOD†

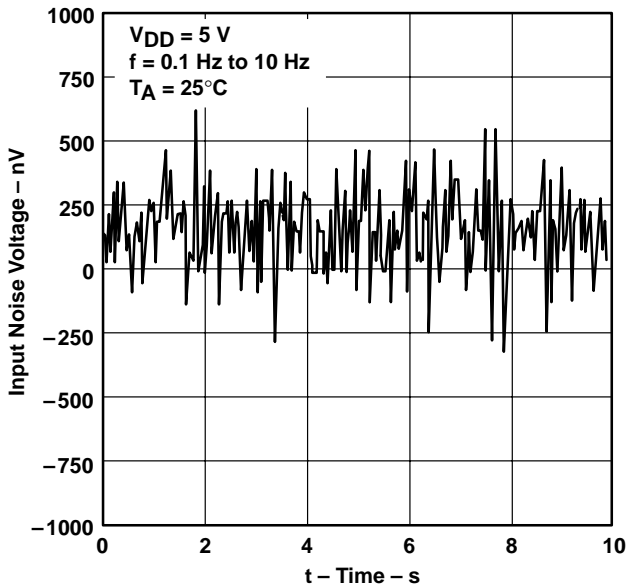

Figure 45

TOTAL HARMONIC DISTORTION PLUS NOISE†
 vs
 FREQUENCY

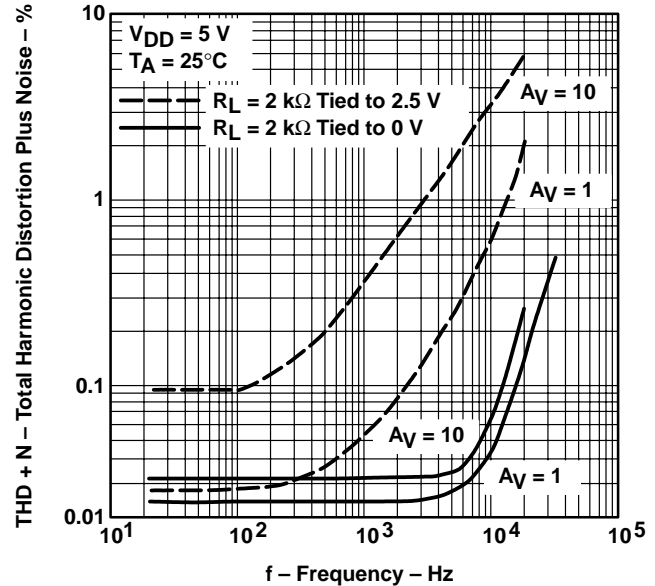

Figure 46

† For all curves where $V_{DD} = 5\text{ V}$, all loads are referenced to 2.5 V. For all curves where $V_{DD} = 3\text{ V}$, all loads are referenced to 1.5 V.

TYPICAL CHARACTERISTICS

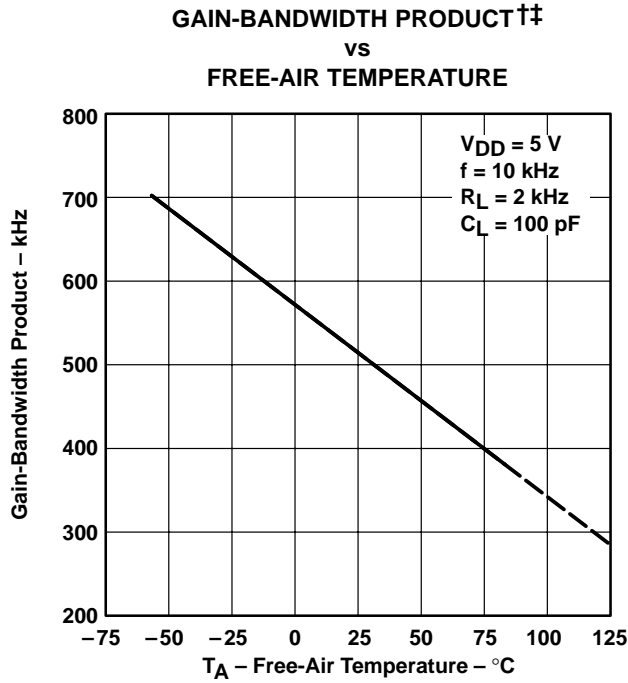

Figure 47

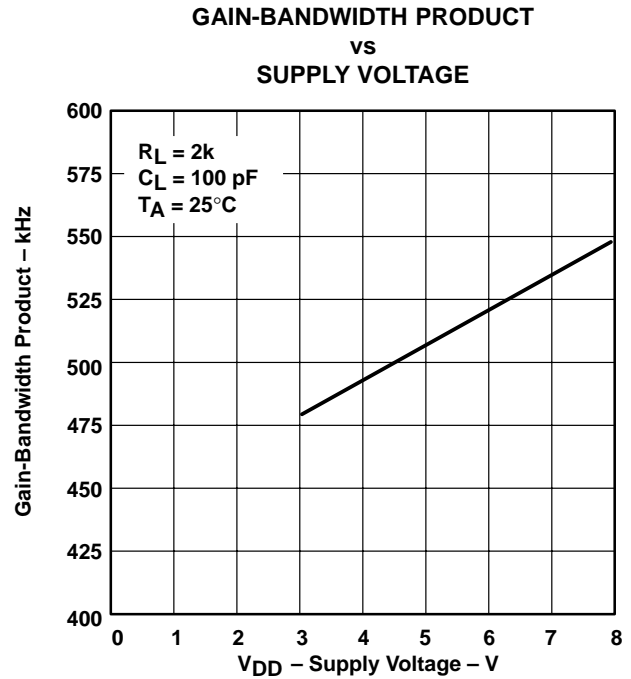

Figure 48

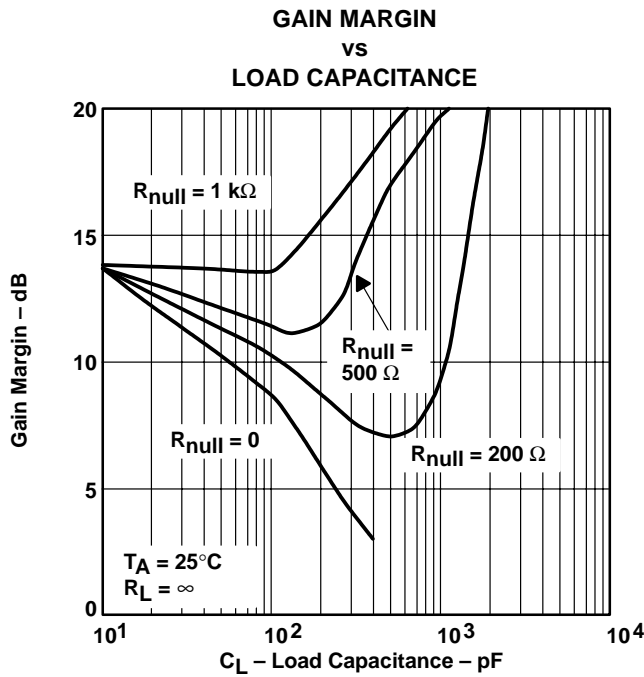

Figure 49

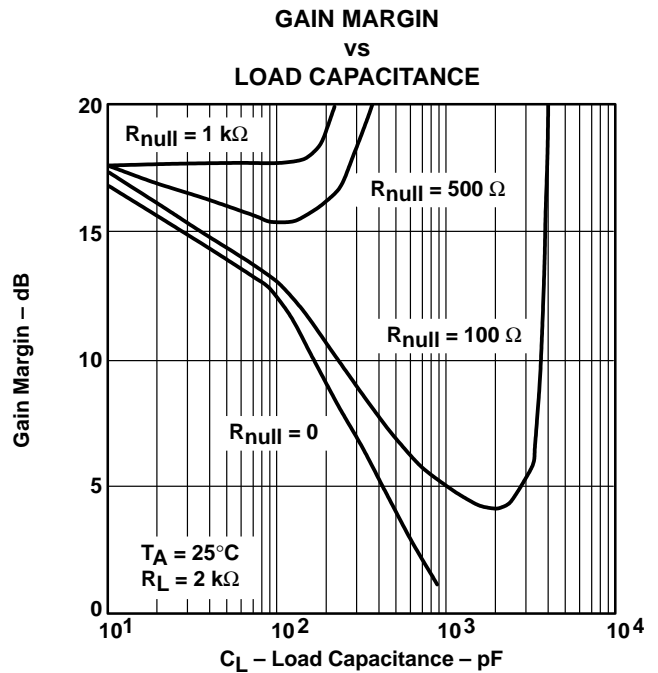

Figure 50

† Data at high and low temperatures are applicable only within the rated operating free-air temperature ranges of the various devices.
 †† For all curves where $V_{DD} = 5\text{ V}$, all loads are referenced to 2.5 V. For all curves where $V_{DD} = 3\text{ V}$, all loads are referenced to 1.5 V.

TYPICAL CHARACTERISTICS

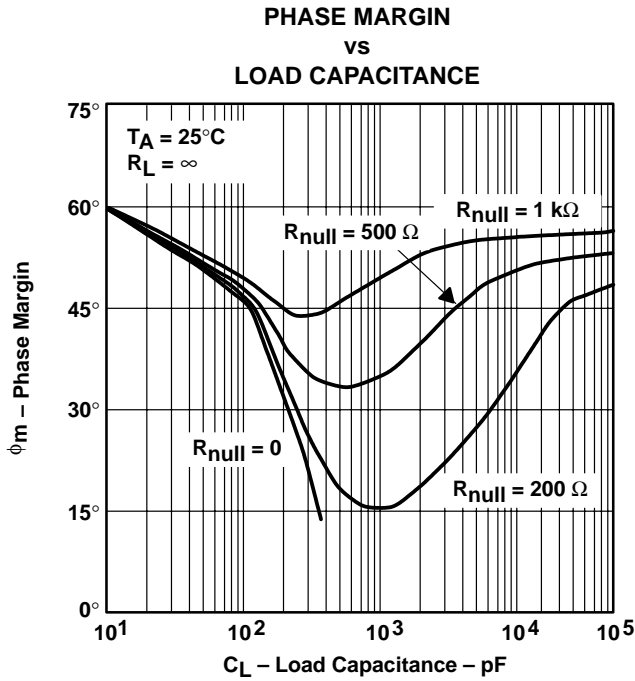

Figure 51

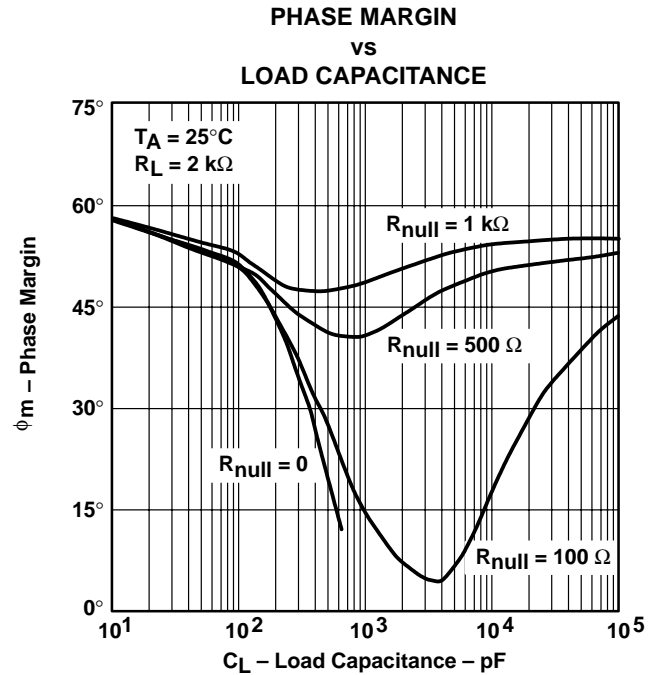

Figure 52

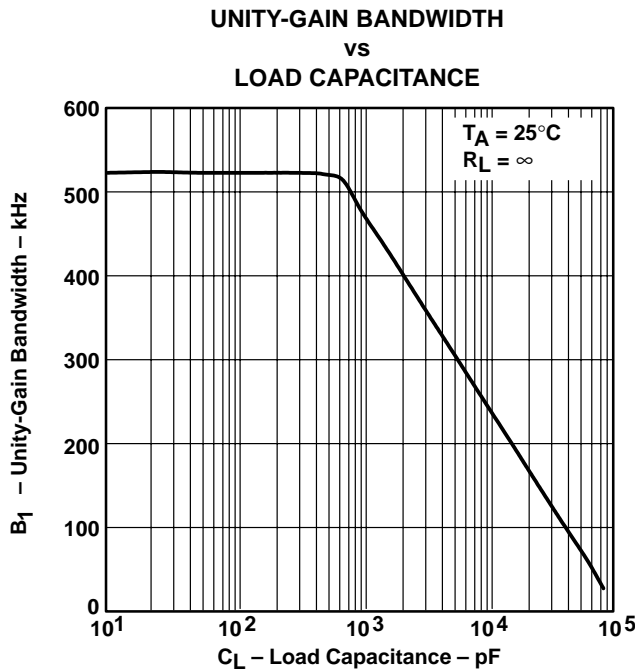

Figure 53

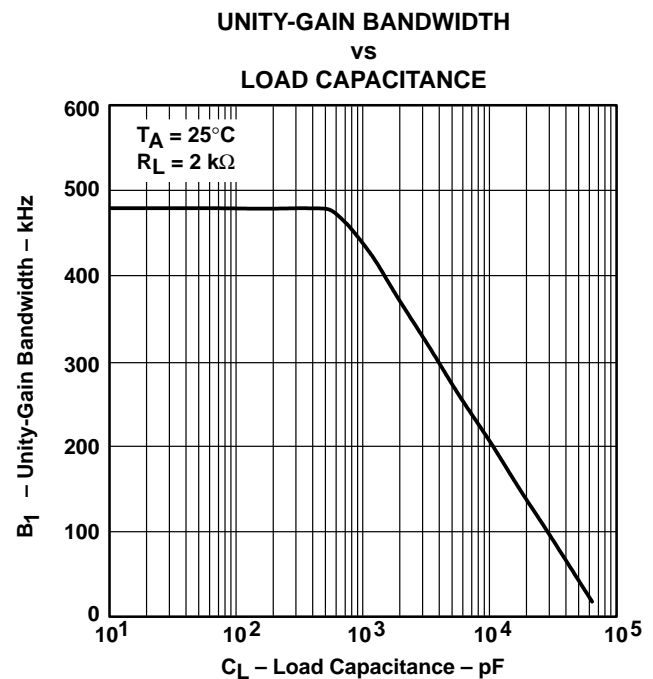

Figure 54

APPLICATION INFORMATION

driving large capacitive loads

The TLV2721 is designed to drive larger capacitive loads than most CMOS operational amplifiers. Figure 49 through Figure 54 illustrate its ability to drive loads greater than 100 pF while maintaining good gain and phase margins ($R_{null} = 0$).

A small series resistor (R_{null}) at the output of the device (Figure 55) improves the gain and phase margins when driving large capacitive loads. Figure 49 through Figure 52 show the effects of adding series resistances of 100 Ω , 200 Ω , 500 Ω , and 1 k Ω . The addition of this series resistor has two effects: the first effect is that it adds a zero to the transfer function and the second effect is that it reduces the frequency of the pole associated with the output load in the transfer function.

The zero introduced to the transfer function is equal to the series resistance times the load capacitance. To calculate the approximate improvement in phase margin, equation 1 can be used.

$$\Delta\phi_{m1} = \tan^{-1} \left(2 \times \pi \times \text{UGBW} \times R_{null} \times C_L \right) \quad (1)$$

Where :

- $\Delta\phi_{m1}$ = Improvement in phase margin
- UGBW = Unity-gain bandwidth frequency
- R_{null} = Output series resistance
- C_L = Load capacitance

The unity-gain bandwidth (UGBW) frequency decreases as the capacitive load increases (Figure 53 and Figure 54). To use equation 1, UGBW must be approximated from Figure 54 and Figure 55.

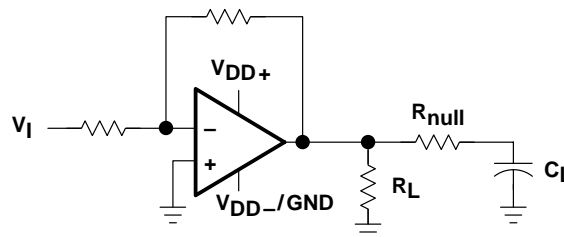

Figure 55. Series-Resistance Circuit

The TLV2721 is designed to provide better sinking and sourcing output currents than earlier CMOS rail-to-rail output devices. This device is specified to sink 500 μA and source 1 mA at $V_{DD} = 5\text{ V}$ at a maximum quiescent I_{DD} of 200 μA . This provides a greater than 80% power efficiency.

When driving heavy dc loads, such as 2 k Ω , the positive edge under slewing conditions can experience some distortion. This condition can be seen in Figure 37. This condition is affected by three factors:

- Where the load is referenced. When the load is referenced to either rail, this condition does not occur. The distortion occurs only when the output signal swings through the point where the load is referenced. Figure 38 illustrates two 2-k Ω load conditions. The first load condition shows the distortion seen for a 2-k Ω load tied to 2.5 V. The third load condition in Figure 38 shows no distortion for a 2-k Ω load tied to 0 V.
- Load resistance. As the load resistance increases, the distortion seen on the output decreases. Figure 38 illustrates the difference seen on the output for a 2-k Ω load and a 100-k Ω load with both tied to 2.5 V.
- Input signal edge rate. Faster input edge rates for a step input result in more distortion than with slower input edge rates.

TLV2721, TLV2721Y

Advanced LinCMOS™ RAIL-TO-RAIL

VERY LOW-POWER SINGLE OPERATIONAL AMPLIFIERS

SLOS197A – AUGUST 1997 – REVISED MARCH 2001

APPLICATION INFORMATION

macromodel information

Macromodel information provided was derived using Microsim *Parts*™, the model generation software used with Microsim *PSpice*™. The Boyle macromodel (see Note 6) and subcircuit in Figure 56 are generated using the TLV2721 typical electrical and operating characteristics at $T_A = 25^\circ\text{C}$. Using this information, output simulations of the following key parameters can be generated to a tolerance of 20% (in most cases):

- Maximum positive output voltage swing
- Maximum negative output voltage swing
- Slew rate
- Quiescent power dissipation
- Input bias current
- Open-loop voltage amplification
- Unity-gain frequency
- Common-mode rejection ratio
- Phase margin
- DC output resistance
- AC output resistance
- Short-circuit output current limit

NOTE 6: G. R. Boyle, B. M. Cohn, D. O. Pederson, and J. E. Solomon, "Macromodeling of Integrated Circuit Operational Amplifiers", *IEEE Journal of Solid-State Circuits*, SC-9, 353 (1974).

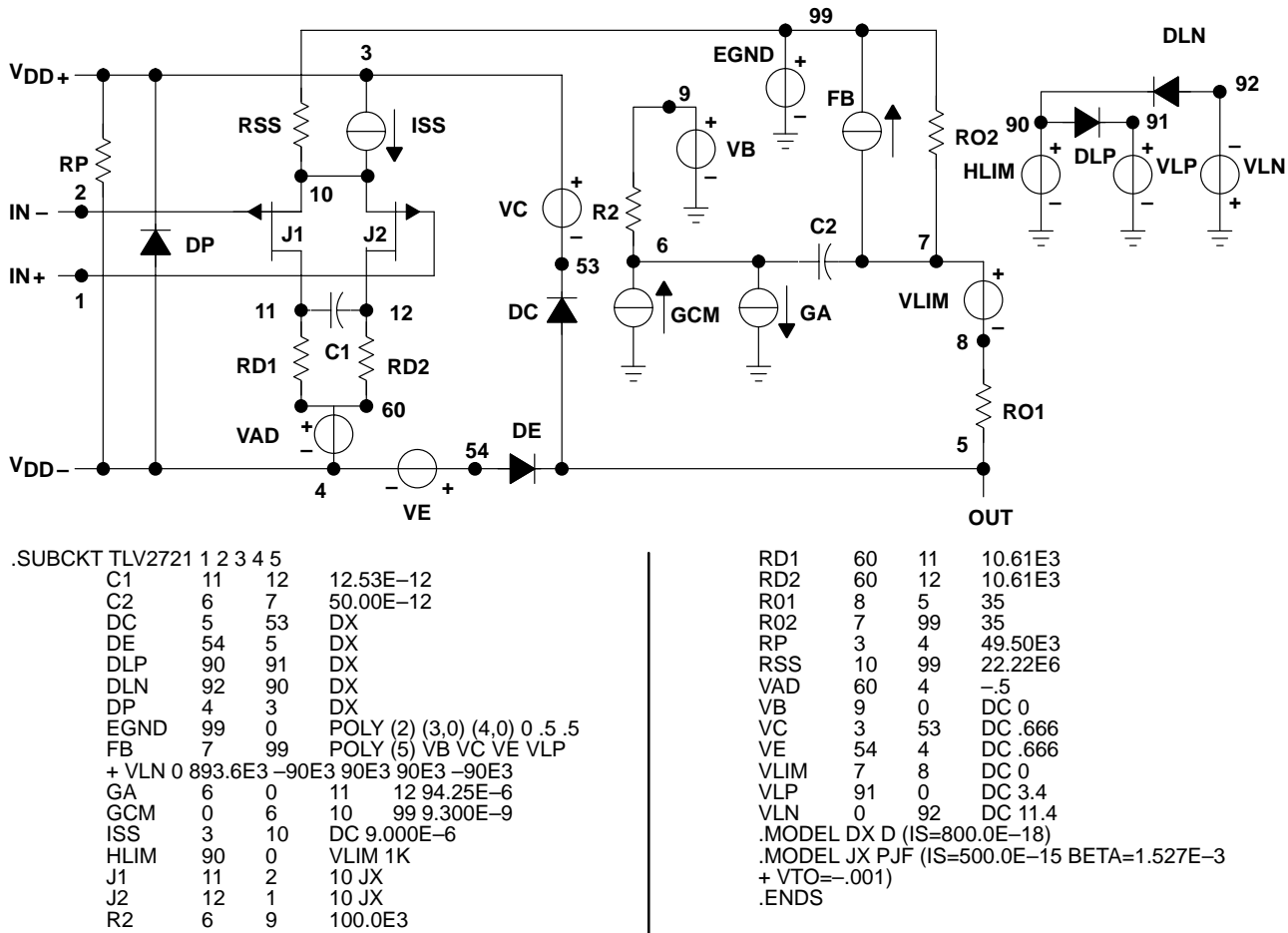

Figure 56. Boyle Macromodel and Subcircuit

PSpice and *Parts* are trademark of MicroSim Corporation.

Macromodels, simulation models, or other models provided by TI, directly or indirectly, are not warranted by TI as fully representing all of the specification and operating characteristics of the semiconductor product to which the model relates.



POST OFFICE BOX 655303 • DALLAS, TEXAS 75265

MECHANICAL INFORMATION

DBV (R-PDSO-G5)

PLASTIC SMALL-OUTLINE

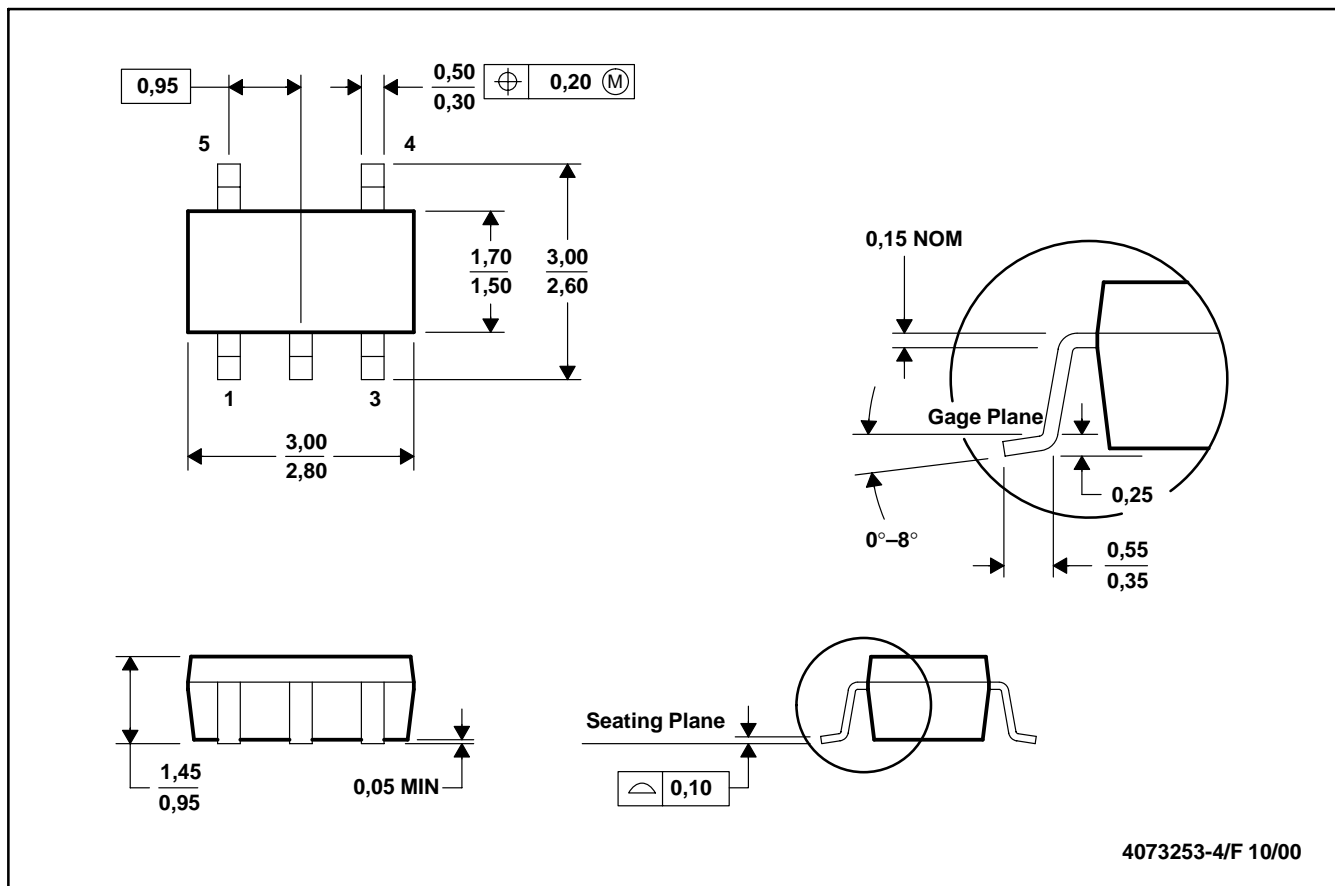

- NOTES: A. All linear dimensions are in millimeters.
 B. This drawing is subject to change without notice.
 C. Body dimensions do not include mold flash or protrusion.
 D. Falls within JEDEC MO-178

IMPORTANT NOTICE

Texas Instruments and its subsidiaries (TI) reserve the right to make changes to their products or to discontinue any product or service without notice, and advise customers to obtain the latest version of relevant information to verify, before placing orders, that information being relied on is current and complete. All products are sold subject to the terms and conditions of sale supplied at the time of order acknowledgment, including those pertaining to warranty, patent infringement, and limitation of liability.

TI warrants performance of its products to the specifications applicable at the time of sale in accordance with TI's standard warranty. Testing and other quality control techniques are utilized to the extent TI deems necessary to support this warranty. Specific testing of all parameters of each device is not necessarily performed, except those mandated by government requirements.

Customers are responsible for their applications using TI components.

In order to minimize risks associated with the customer's applications, adequate design and operating safeguards must be provided by the customer to minimize inherent or procedural hazards.

TI assumes no liability for applications assistance or customer product design. TI does not warrant or represent that any license, either express or implied, is granted under any patent right, copyright, mask work right, or other intellectual property right of TI covering or relating to any combination, machine, or process in which such products or services might be or are used. TI's publication of information regarding any third party's products or services does not constitute TI's approval, license, warranty or endorsement thereof.

Reproduction of information in TI data books or data sheets is permissible only if reproduction is without alteration and is accompanied by all associated warranties, conditions, limitations and notices. Representation or reproduction of this information with alteration voids all warranties provided for an associated TI product or service, is an unfair and deceptive business practice, and TI is not responsible nor liable for any such use.

Resale of TI's products or services with statements different from or beyond the parameters stated by TI for that product or service voids all express and any implied warranties for the associated TI product or service, is an unfair and deceptive business practice, and TI is not responsible nor liable for any such use.

Also see: [Standard Terms and Conditions of Sale for Semiconductor Products](http://www.ti.com/sc/docs/stdterms.htm). www.ti.com/sc/docs/stdterms.htm

Mailing Address:

Texas Instruments
Post Office Box 655303
Dallas, Texas 75265