

2.7-V TO 5.5-V LOW-POWER DUAL 12-BIT DIGITAL-TO-ANALOG CONVERTER WITH INTERNAL REFERENCE AND POWER DOWN

FEATURES

- Dual 12-Bit Voltage Output DAC
- Programmable Internal Reference
- Programmable Settling Time:
 - 1 μ s in Fast Mode,
 - 3.5 μ s in Slow Mode
- Compatible With TMS320 and SPI™ Serial Ports
- Differential Nonlinearity <0.5 LSB Typ
- Monotonic Over Temperature

APPLICATIONS

- Digital Servo Control Loops
- Digital Offset and Gain Adjustment
- Industrial Process Control
- Machine and Motion Control Devices
- Mass Storage Devices

D, JG PACKAGE
(TOP VIEW)

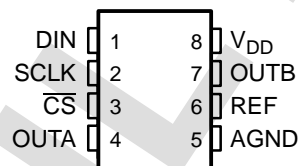

FK PACKAGE
(TOP VIEW)

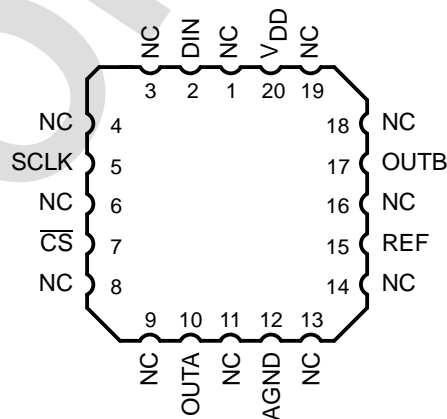

DESCRIPTION

The TLV5638 is a dual 12-bit voltage output DAC with a flexible 3-wire serial interface. The serial interface allows glueless interface to TMS320, SPI™, QSPI™, and Microwire™ serial ports. It is programmed with a 16-bit serial string containing 4 control and 12 data bits.

The resistor string output voltage is buffered by a x2 gain rail-to-rail output buffer. The buffer features a Class AB output stage to improve stability and reduce settling time. The programmable settling time of the DAC allows the designer to optimize speed vs power dissipation. With its on-chip programmable precision voltage reference, the TLV5638 simplifies overall system design.

Because of its ability to source up to 1 mA, the reference can also be used as a system reference. Implemented with a CMOS process, the device is designed for single supply operation from 2.7 V to 5.5 V. It is available in an 8-pin SOIC package to reduce board space in standard commercial, industrial, and automotive temperature ranges. It is also available in JG and FK packages in the military temperature range.



Please be aware that an important notice concerning availability, standard warranty, and use in critical applications of Texas Instruments semiconductor products and disclaimers thereto appears at the end of this data sheet.

SPI, QSPI are trademarks of Motorola, Inc.

Microwire is a trademark of National Semiconductor Corporation.



This integrated circuit can be damaged by ESD. Texas Instruments recommends that all integrated circuits be handled with appropriate precautions. Failure to observe proper handling and installation procedures can cause damage.

ESD damage can range from subtle performance degradation to complete device failure. Precision integrated circuits may be more susceptible to damage because very small parametric changes could cause the device not to meet its published specifications.

AVAILABLE OPTIONS

T _A	PACKAGE		
	SOIC (D)	CERAMIC DIP (JG)	20 PAD LCCC (FK)
0°C to 70°C	TLV5638CD	—	—
40°C to 85°C	TLV5638ID	—	—
40°C to 125°C	TLV5638QD TLV5638QDR	—	—
55°C to 125°C	—	TLV5638MJG	TLV5638MFK

FUNCTIONAL BLOCK DIAGRAM

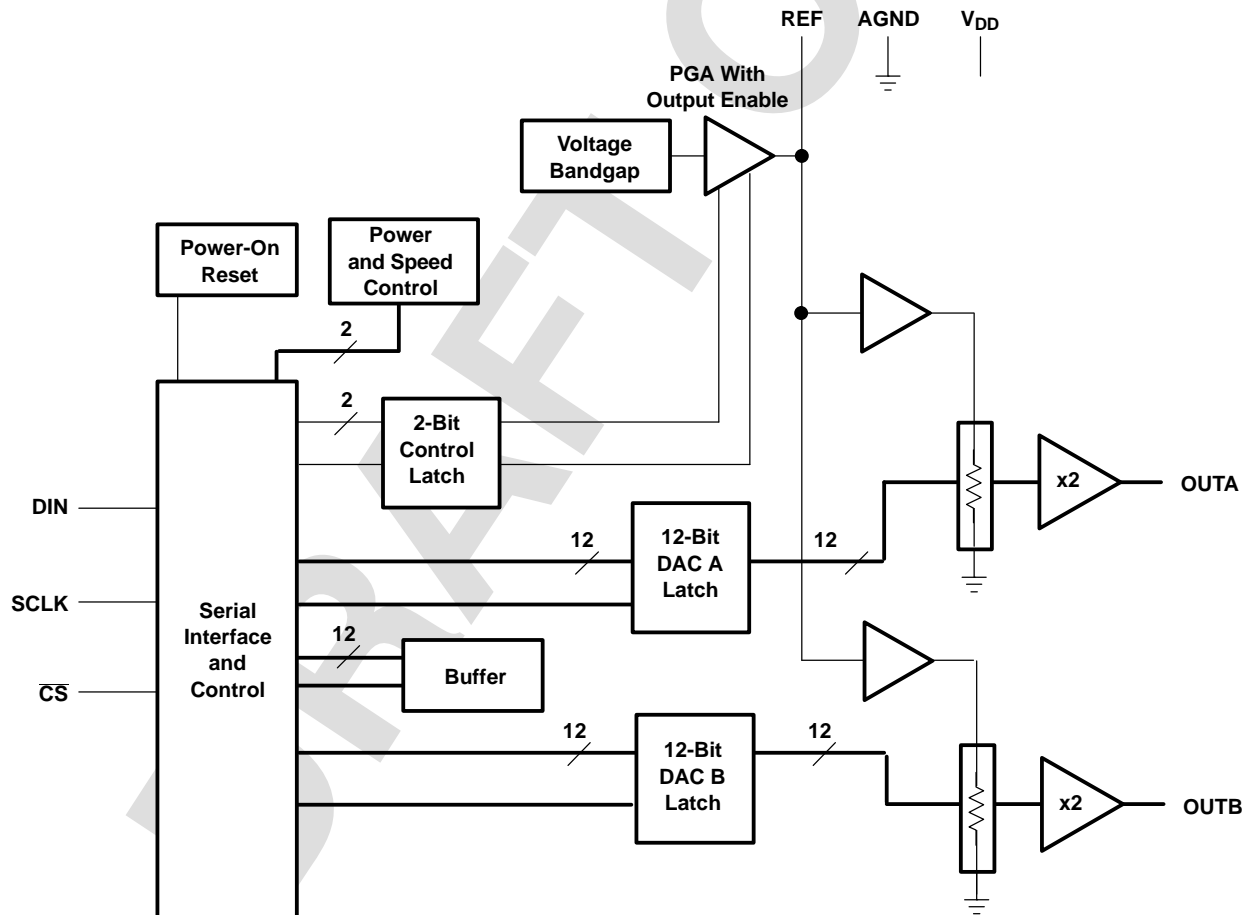

Terminal Functions

TERMINAL NAME	NO.	I/O/P	DESCRIPTION
AGND	5	P	Ground
\overline{CS}	3	I	Chip select. Digital input active low, used to enable/disable inputs
DIN	1	I	Digital serial data input
OUT A	4	O	DAC A analog voltage output
OUT B	7	O	DAC B analog voltage output
REF	6	I/O	Analog reference voltage input/output
SCLK	2	I	Digital serial clock input
V _{DD}	8	P	Positive power supply

ABSOLUTE MAXIMUM RATINGS

over operating free-air temperature range (unless otherwise noted)⁽¹⁾

	UNIT	
Supply voltage (V _{DD} to AGND)	7 V	
Reference input voltage range	-0.3 V to V _{DD} + 0.3 V	
Digital input voltage range	-0.3 V to V _{DD} + 0.3 V	
Operating free-air temperature range, T _A	TLV5638C	0°C to 70°C
	TLV5638I	-40°C to 85°C
	TLV5638Q	-40°C to 125°C
	TLV5638M	-55°C to 125°C
Storage temperature range, T _{stg}	-65°C to 150°C	
Lead temperature 1,6 mm (1/16 inch) from case for 10 seconds	260°C	

(1) Stresses beyond those listed under „absolute maximum ratings” may cause permanent damage to the device. These are stress ratings only, and functional operation of the device at these or any other conditions beyond those indicated under „recommended operating conditions” is not implied. Exposure to absolute-maximum-rated conditions for extended periods may affect device reliability.

DISSIPATION RATING TABLE

PACKAGE	T _A ≤ 25°C POWER RATING	DERATING FACTOR ABOVE T _A = 25°C ⁽¹⁾	T _A = 70°C POWER RATING	T _A = 85°C POWER RATING	T _A = 125°C POWER RATING
D	635 mW	5.08 mW/°C	407 mW	330 mW	127 mW
FK	1375 mW	11.00 mW/°C	880 mW	715 mW	275 mW
JG	1050 mW	8.40 mW/°C	672 mW	546 mW	210 mW

(1) This is the inverse of the traditional Junction-to-Ambient thermal Resistance (R_{θJA}). Thermal Resistances are not production tested and are for informational purposes only.

RECOMMENDED OPERATING CONDITIONS

		MIN	NOM	MAX	UNIT	
Supply voltage, V _{DD}	V _{DD} = 5 V	4.5	5	5.5	V	
	V _{DD} = 3 V	2.7	3	3.3	V	
Power on reset, POR		0.55 ⁽¹⁾		2 ⁽¹⁾	V	
High-level digital input voltage, V _{IH}	V _{DD} = 2.7 V	2			V	
	V _{DD} = 5.5 V	2.4				
Low-level digital input voltage, V _{IL}	V _{DD} = 2.7 V			0.6	V	
	V _{DD} = 5.5 V	TLV5638C and TLV5638I		1	V	
		TLV5638Q and TLV5638M		0.8		
Reference voltage, V _{ref} to REF terminal	V _{DD} = 5 V ⁽²⁾	AGND	2.048	V _{DD} -1.5	V	
Reference voltage, V _{ref} to REF terminal	V _{DD} = 3 V ⁽²⁾	AGND	1.024	V _{DD} -1.5	V	
Load resistance, R _L		2			kΩ	
Load capacitance, C _L					100	pF
Clock frequency, f _{CLK}					20	MHz
Operating free-air temperature, T _A	TLV5638C	0		70	°C	
	TLV5638I	40		85		
	TLV5638Q	40		125		
	TLV5638M	55		125		

(1) This parameter is not tested for Q and M suffix devices.

(2) Due to the x2 output buffer, a reference input voltage $\geq (V_{DD}-0.4\text{ V})/2$ causes clipping of the transfer function. The output buffer of the internal reference must be disabled, if an external reference is used.

ELECTRICAL CHARACTERISTICS

over recommended operating conditions, V_{ref} = 2.048 V, V_{ref} = 1.024 V (unless otherwise noted)

POWER SUPPLY						
PARAMETER	TEST CONDITIONS		TLV5638C, I TLV5638M			UNIT
			MIN	TYP	MAX	
I _{DD} Power supply current	No load, All inputs = AGND or V _{DD} , DAC latch = 0x800	V _{DD} = 5 V, Int. ref.	Fast	4.3	7	mA
			Slow	2.2	3.6	
		V _{DD} = 3 V, Int. ref.	Fast	3.8	6.3	mA
			Slow	1.8	3.0	
		V _{DD} = 5 V, Ext. ref.	Fast	3.9	6.3	mA
			Slow	1.8	3.0	
		V _{DD} = 3 V, Ext. ref.	Fast	3.5	5.7	mA
			Slow	1.5	2.6	
Power-down supply current				0.01	10	μA
PSRR Power supply rejection ratio	Zero scale, ⁽¹⁾				65	dB
	Full scale, ⁽²⁾				65	

(1) Power supply rejection ratio at zero scale is measured by varying V_{DD} and is given by: PSRR = 20 log [(E_{ZS}(V_{DD}max) - E_{ZS}(V_{DD}min))/V_{DD}max]

(2) Power supply rejection ratio at full scale is measured by varying V_{DD} and is given by: PSRR = 20 log [(E_G(V_{DD}max) - E_G(V_{DD}min))/V_{DD}max]

ELECTRICAL CHARACTERISTICS (CONTINUED)

over recommended operating conditions, $V_{ref} = 2.048\text{ V}$, $V_{ref} = 1.024\text{ V}$ (unless otherwise noted)

STATIC DAC SPECIFICATIONS							
PARAMETER		TEST CONDITIONS	MIN	TYP	MAX	UNIT	
Resolution			12			bits	
INL	Integral nonlinearity, end point adjusted	See (1)		C and I suffixes	±1.7	±4	LSB
				Q and M suffixes	±1.7	±6	LSB
DNL	Differential nonlinearity	See (2)		±0.4	±1	LSB	
E_{ZS}	Zero-scale error (offset error at zero scale)	See (3)			±24	mV	
$E_{ZS\text{TC}}$	Zero-scale-error temperature coefficient	See (4)		10		ppm/°C	
E_G	Gain error	See (5)			±0.6	% full scale V	
$E_{G\text{TC}}$	Gain error temperature coefficient	See (6)		10		ppm/°C	
OUTPUT SPECIFICATIONS							
V_O	Output voltage	$R_L = 10\text{ k}\Omega$	0		$V_{DD}-0.4$	V	
	Output load regulation accuracy	$V_O = 4.096\text{ V}, 2.048\text{ V}, R_L = 2\text{ k}\Omega$			±0.25	% full scale V	
REFERENCE PIN CONFIGURED AS OUTPUT (REF)							
Vref(OUTL)	Low reference voltage		1.003	1.024	1.045	V	
Vref(OUTH)	High reference voltage	$V_{DD} > 4.75\text{ V}$	2.027	2.048	2.069	V	
Iref(source)	Output source current				1	mA	
Iref(sink)	Output sink current		-1			mA	
	Load capacitance				100	pF	
PSRR	Power supply rejection ratio			-65		dB	
REFERENCE PIN CONFIGURED AS INPUT (REF)							
V_I	Input voltage		0		$V_{DD}-1.5$	V	
R_I	Input resistance			10		M Ω	
C_I	Input capacitance			5		pF	
	Reference input bandwidth	REF = $0.2 V_{pp} + 1.024\text{ V dc}$	Fast	1.3		MHz	
			Slow	525		kHz	
	Reference feedthrough	REF = $1 V_{pp}$ at 1.024 V dc (7)		-80		dB	
DIGITAL INPUTS							
I_{IH}	High-level digital input current	$V_I = V_{DD}$			1	μA	
I_{IL}	Low-level digital input current	$V_I = 0\text{ V}$	-1			μA	
C_i	Input capacitance			8		pF	

- (1) The relative accuracy or integral nonlinearity (INL) sometimes referred to as linearity error, is the maximum deviation of the output from the line between zero and full scale excluding the effects of zero code and full-scale errors. Tested from code 32 to 4095.
- (2) The differential nonlinearity (DNL) sometimes referred to as differential error, is the difference between the measured and ideal 1 LSB amplitude change of any two adjacent codes. Monotonic means the output voltage changes in the same direction (or remains constant) as a change in the digital input code.
- (3) Zero-scale error is the deviation from zero voltage output when the digital input code is zero.
- (4) Zero-scale-error temperature coefficient is given by: $E_{ZS\text{TC}} = [E_{ZS}(T_{max}) - E_{ZS}(T_{min})]/V_{ref} \times 10^6/(T_{max} - T_{min})$.
- (5) Gain error is the deviation from the ideal output ($2V_{ref} - 1\text{ LSB}$) with an output load of $10\text{ k}\Omega$ excluding the effects of the zero-error.
- (6) Gain temperature coefficient is given by: $E_{G\text{TC}} = [E_G(T_{max}) - E_G(T_{min})]/V_{ref} \times 10^6/(T_{max} - T_{min})$.
- (7) Reference feedthrough is measured at the DAC output with an input code = 0x000.

ELECTRICAL CHARACTERISTICS (CONTINUED)

over recommended operating conditions, $V_{ref} = 2.048\text{ V}$, $V_{ref} = 1.024\text{ V}$ (unless otherwise noted)

ANALOG OUTPUT DYNAMIC PERFORMANCE						
PARAMETER		TEST CONDITIONS	MIN	TYP	MAX	UNIT
$t_{s(FS)}$	Output settling time, full scale	$R_L = 10\text{ k}\Omega$, $C_L = 100\text{ pF}$, See ⁽¹⁾	Fast	1	3	μs
			Slow	3.5	7	
$t_{s(CC)}$	Output settling time, code to code	$R_L = 10\text{ k}\Omega$, $C_L = 100\text{ pF}$, See ⁽²⁾	Fast	0.5	1.5	μs
			Slow	1	2	
SR	Slew rate	$R_L = 10\text{ k}\Omega$, $C_L = 100\text{ pF}$, See ⁽³⁾	Fast	12		$\text{V}/\mu\text{s}$
			Slow	1.8		
Glitch energy		$\text{DIN} = 0\text{ to }1$, $\text{FCLK} = 100\text{ kHz}$, $\overline{\text{CS}} = V_{DD}$		5		$\text{nV}\cdot\text{s}$
SNR	Signal-to-noise ratio	$f_s = 480\text{ kSPS}$, $f_{out} = 1\text{ kHz}$, $R_L = 10\text{ k}\Omega$, $C_L = 100\text{ pF}$		69	74	dB
S/(N+D)	Signal-to-noise + distortion			58	67	
THD	Total harmonic distortion			69	57	
Spurious free dynamic range				57	72	

- (1) Settling time is the time for the output signal to remain within $\pm 0.5\text{ LSB}$ of the final measured value for a digital input code change of $0x020$ to $0xFDF$ and $0xFDF$ to $0x020$ respectively. Not tested, assured by design.
- (2) Settling time is the time for the output signal to remain within $\pm 0.5\text{ LSB}$ of the final measured value for a digital input code change of one count. Not tested, assured by design.
- (3) Slew rate determines the time it takes for a change of the DAC output from 10% to 90% full-scale voltage.

DIGITAL INPUT TIMING REQUIREMENTS

	MIN	NOM	MAX	UNIT
$t_{su(CS-CK)}$ Setup time, $\overline{\text{CS}}$ low before first negative SCLK edge	10			ns
$t_{su(C16-CS)}$ Setup time, 16 th negative SCLK edge (when D0 is sampled) before $\overline{\text{CS}}$ rising edge	10			ns
t_{wH} SCLK pulse width high	25			ns
t_{wL} SCLK pulse width low	25			ns
$t_{su(D)}$ Setup time, data ready before SCLK falling edge	10			ns
$t_{h(D)}$ Hold time, data held valid after SCLK falling edge	5			ns

PARAMETER MEASUREMENT INFORMATION

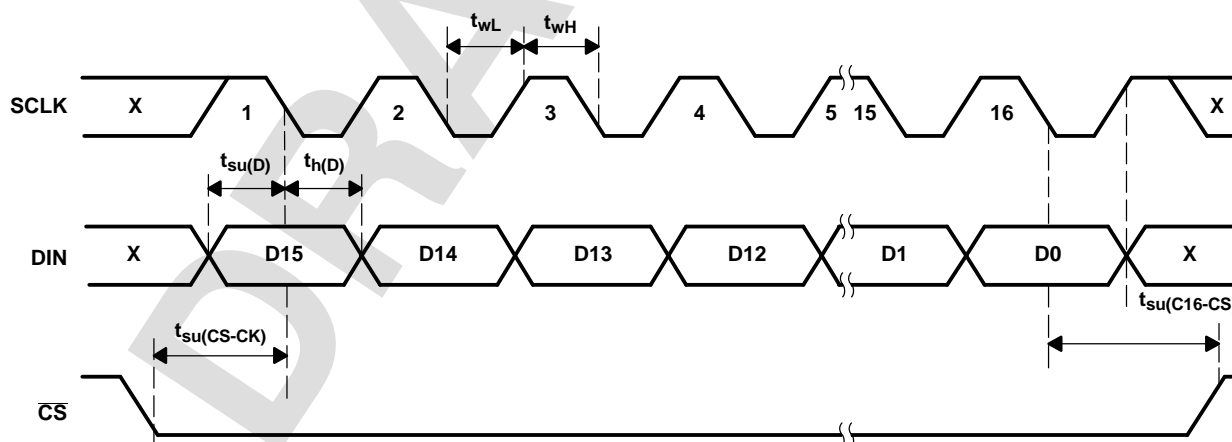

Figure 1. Timing Diagram

TYPICAL CHARACTERISTICS

**POWER DOWN SUPPLY CURRENT
vs
TIME**

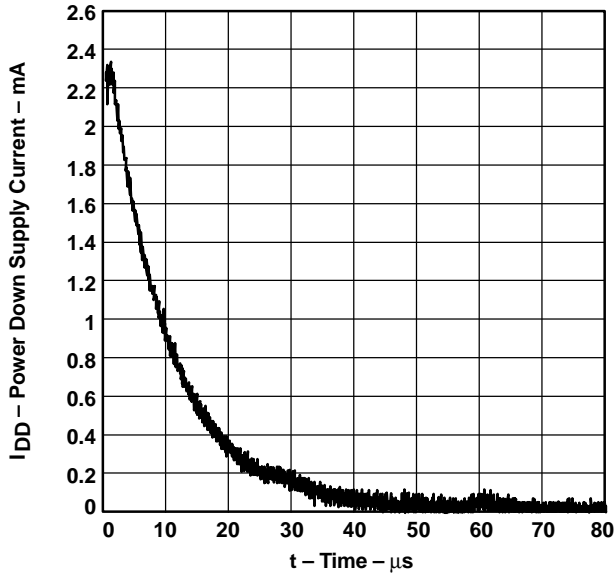

Figure 2.

**SUPPLY CURRENT
vs
FREE-AIR TEMPERATURE**

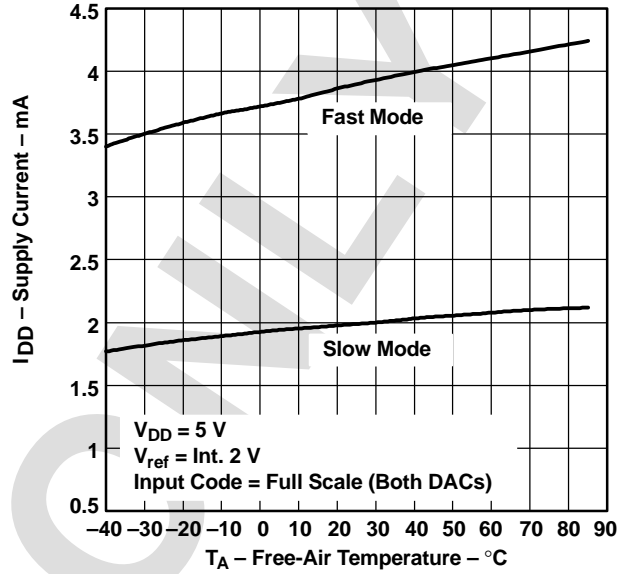

Figure 3.

**SUPPLY CURRENT
vs
FREE-AIR TEMPERATURE**

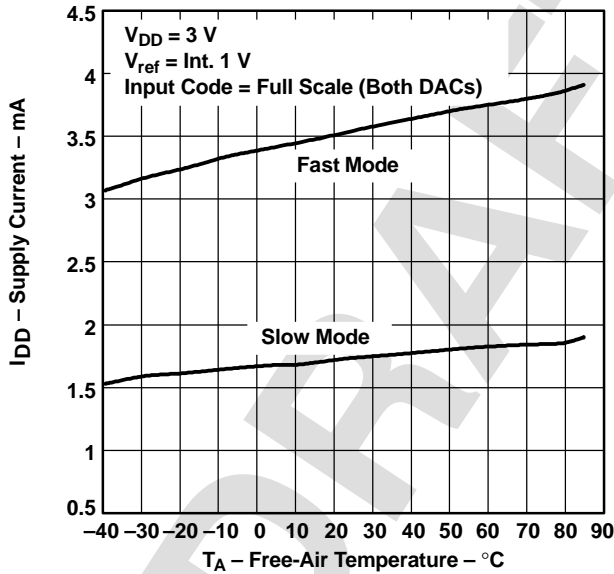

Figure 4.

**OUTPUT VOLTAGE
vs
LOAD CURRENT**

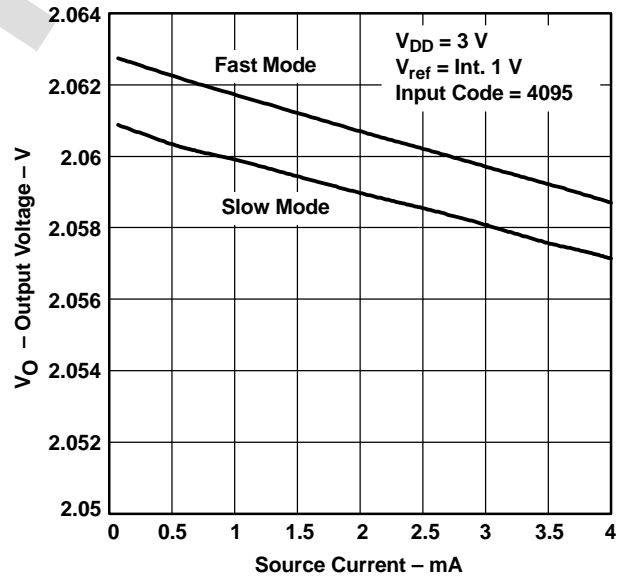

Figure 5.

TYPICAL CHARACTERISTICS (continued)

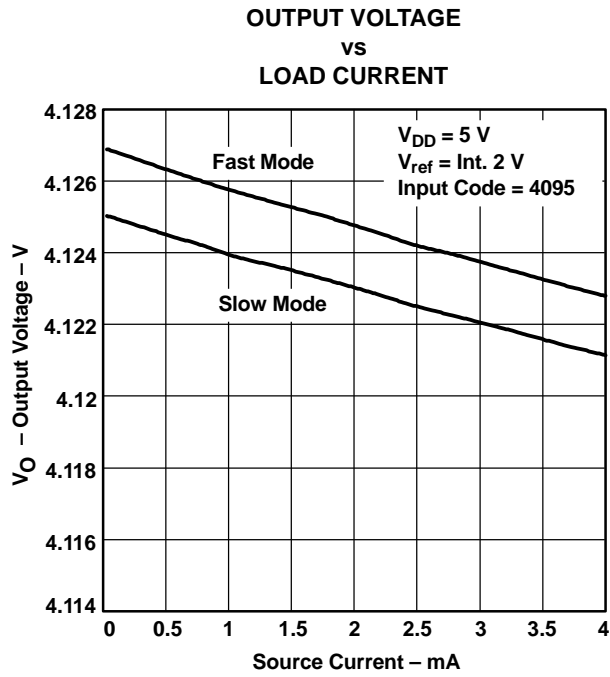

Figure 6.

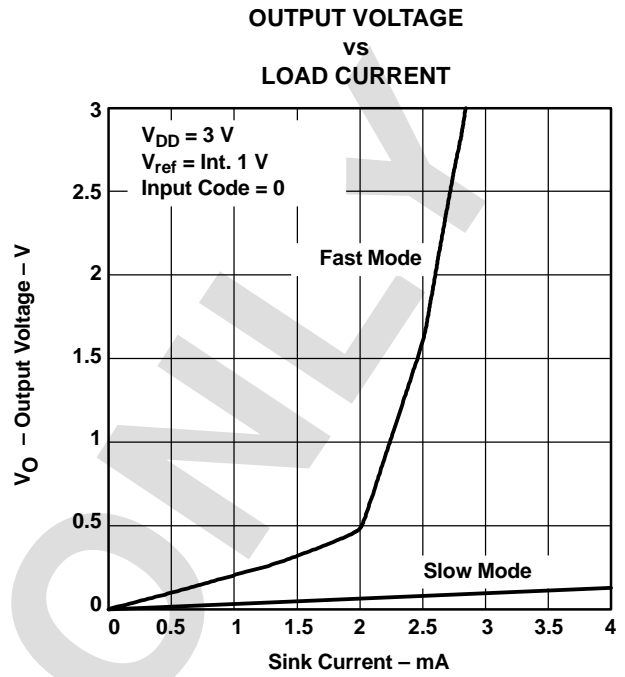

Figure 7.

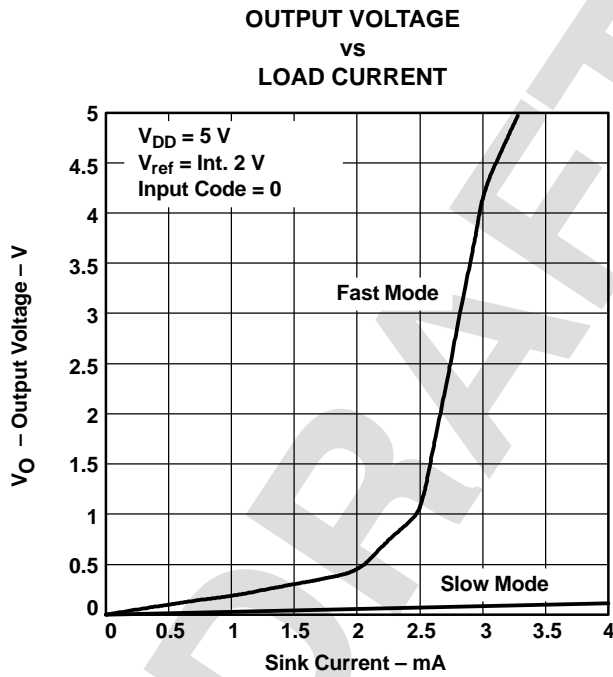

Figure 8.

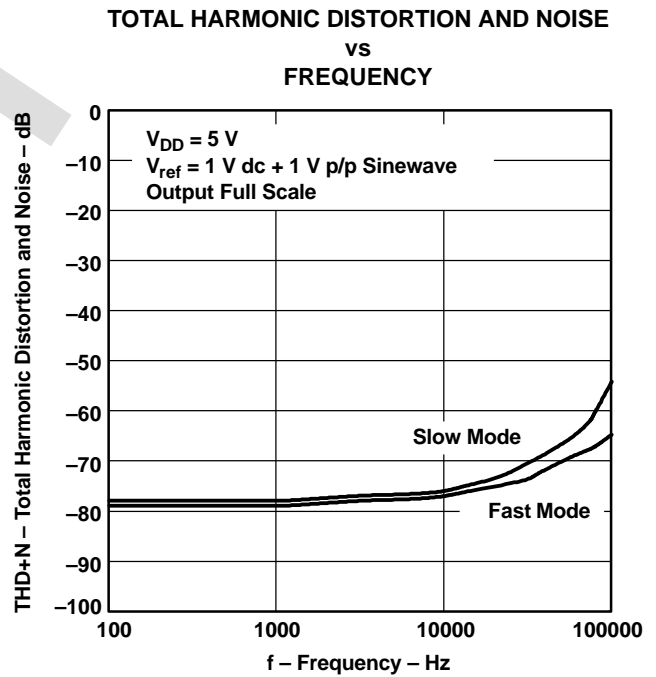

Figure 9.

TYPICAL CHARACTERISTICS (continued)

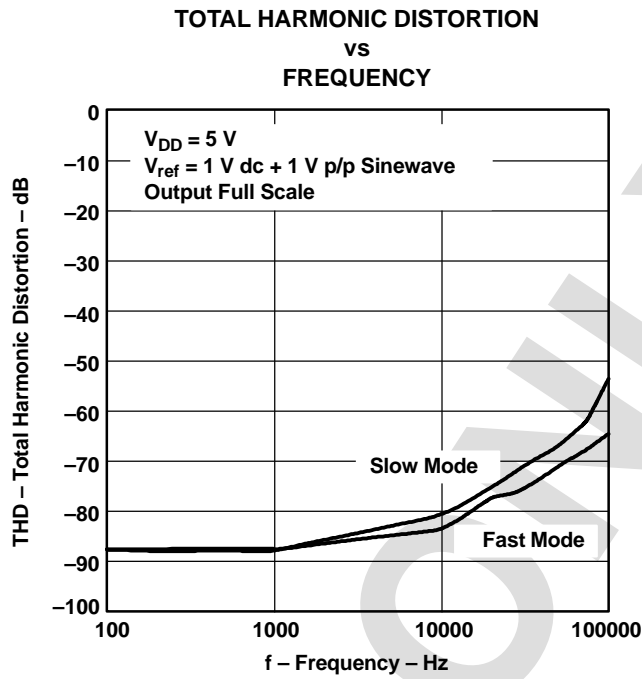
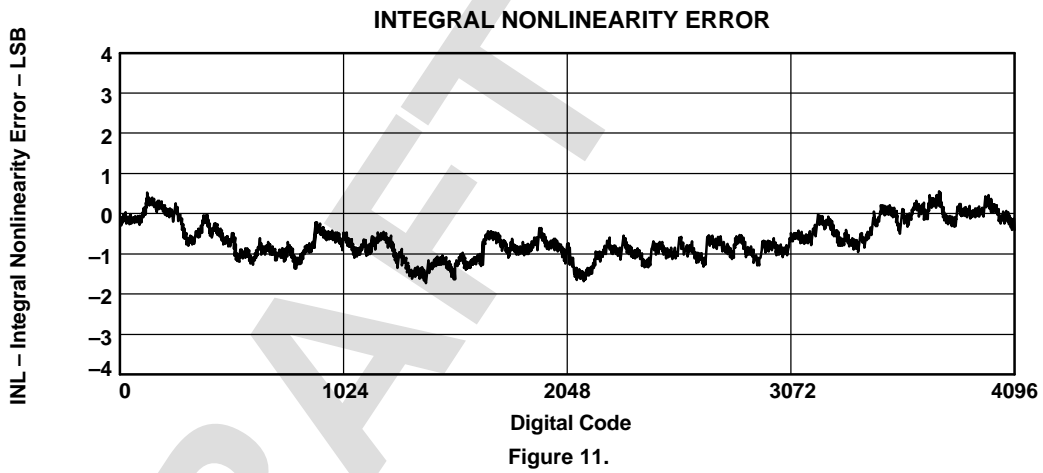

Figure 10.



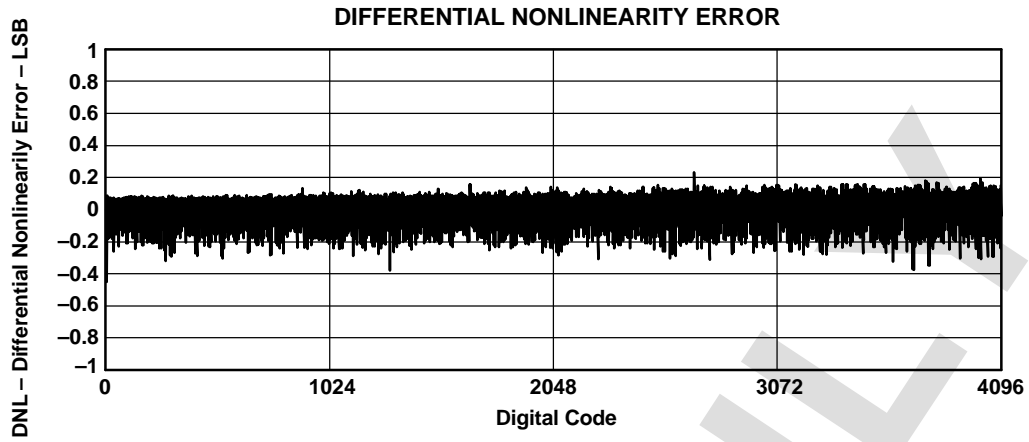

Figure 12.

DRAFT ONLY

APPLICATION INFORMATION

GENERAL FUNCTION

The TLV5638 is a dual 12-bit, single supply DAC, based on a resistor string architecture. It consists of a serial interface, a speed and power-down control logic, a programmable internal reference, a resistor string, and a rail-to-rail output buffer.

The output voltage (full scale determined by reference) is given by:

$$2 \text{ REF} \frac{\text{CODE}}{0x1000} \text{ [V]}$$

Where REF is the reference voltage and CODE is the digital input value in the range 0x000 to 0xFFF. A power on reset initially puts the internal latches to a defined state (all bits zero).

SERIAL INTERFACE

A falling edge of $\overline{\text{CS}}$ starts shifting the data bit-per-bit (starting with the MSB) to the internal register on the falling edges of SCLK. After 16 bits have been transferred or $\overline{\text{CS}}$ rises, the content of the shift register is moved to the target latches (DAC A, DAC B, BUFFER, CONTROL), depending on the control bits within the data word.

Figure 13 shows examples of how to connect the TLV5638 to TMS320, SPI™, and Microwire™.

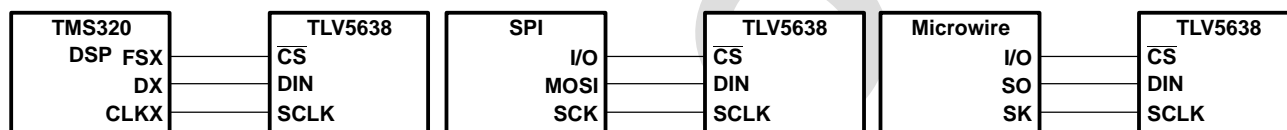

Figure 13. Three-Wire Interface

Notes on SPI™ and Microwire™: Before the controller starts the data transfer, the software has to generate a falling edge on the pin connected to FS. If the word width is 8 bits (SPI™ and Microwire™), two write operations must be performed to program the TLV5638. After the write operation(s), the holding registers or the control register are updated automatically on the 16th positive clock edge.

SERIAL CLOCK FREQUENCY AND UPDATE RATE

The maximum serial clock frequency is given by:

$$f_{\text{sclmax}} = \frac{1}{t_{\text{whmin}} + t_{\text{wlmin}}} = 20 \text{ MHz}$$

The maximum update rate is:

$$f_{\text{updatemax}} = \frac{1}{16(t_{\text{whmin}} + t_{\text{wlmin}})} = 1.25 \text{ MHz}$$

Note, that the maximum update rate is just a theoretical value for the serial interface, as the settling time of the TLV5638 has to be considered, too.

EXAMPLES OF OPERATION:

1. Set DAC A output, select fast mode, select internal reference at 2.048 V:
 - a. Set reference voltage to 2.048 V (CONTROL register)

D15	D14	D13	D12	D11	D10	D9	D8	D7	D6	D5	D4	D3	D2	D1	D0
1	1	0	1	0	0	0	0	0	0	0	0	0	0	1	0

- b. Write new DAC A value and update DAC A output:

D15	D14	D13	D12	D11	D10	D9	D8	D7	D6	D5	D4	D3	D2	D1	D0
1	1	0	0	New DAC A output value											

The DAC A output is updated on the rising clock edge after D0 is sampled.

To output data consecutively using the same DAC configuration, it is not necessary to program the CONTROL register again.

2. Set DAC B output, select fast mode, select external reference:
 - a. Select external reference (CONTROL register):

D15	D14	D13	D12	D11	D10	D9	D8	D7	D6	D5	D4	D3	D2	D1	D0
1	1	0	1	0	0	0	0	0	0	0	0	0	0	0	0

- b. Write new DAC B value to BUFFER and update DAC B output:

D15	D14	D13	D12	D11	D10	D9	D8	D7	D6	D5	D4	D3	D2	D1	D0
0	1	0	0	New BUFFER content and DAC B output value											

The DAC A output is updated on the rising clock edge after D0 is sampled.

To output data consecutively using the same DAC configuration, it is not necessary to program the CONTROL register again.

3. Set DAC A value, set DAC B value, update both simultaneously, select slow mode, select internal reference at 1.024 V:
 - a. Set reference voltage to 1.024 V (CONTROL register)

D15	D14	D13	D12	D11	D10	D9	D8	D7	D6	D5	D4	D3	D2	D1	D0
1	0	0	1	0	0	0	0	0	0	0	0	0	0	0	1

- b. Write data for DAC B to BUFFER:

D15	D14	D13	D12	D11	D10	D9	D8	D7	D6	D5	D4	D3	D2	D1	D0
0	0	0	1	New DAC B value											

- c. Write new DAC A value and update DAC A and B simultaneously:

D15	D14	D13	D12	D11	D10	D9	D8	D7	D6	D5	D4	D3	D2	D1	D0
1	0	0	0	New DAC A value											

Both outputs are updated on the rising clock edge after D0 from the DAC A data word is sampled.

To output data consecutively using the same DAC configuration, it is not necessary to program the CONTROL register again.

1. Set power-down mode:

D15	D14	D13	D12	D11	D10	D9	D8	D7	D6	D5	D4	D3	D2	D1	D0
X	X	1	X	X	X	X	X	X	X	X	X	X	X	X	X

#IMPLIED. X = Don't care

LINEARITY, OFFSET, AND GAIN ERROR USING SINGLE ENDED SUPPLIES

When an amplifier is operated from a single supply, the voltage offset can still be either positive or negative. With a positive offset, the output voltage changes on the first code change. With a negative offset, the output voltage may not change with the first code, depending on the magnitude of the offset voltage.

The output amplifier attempts to drive the output to a negative voltage. However, because the most negative supply rail is ground, the output cannot drive below ground and clamps the output at 0 V.

The output voltage then remains at zero until the input code value produces a sufficient positive output voltage to overcome the negative offset voltage, resulting in the transfer function shown in Figure 14.

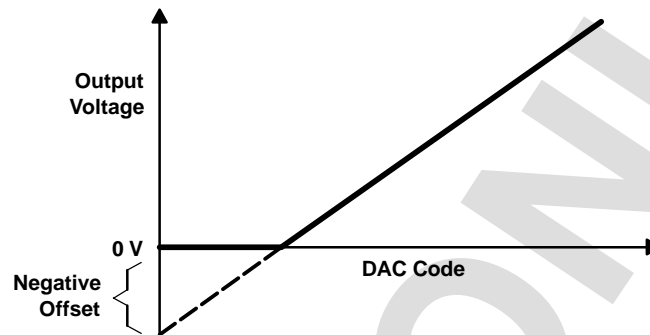

Figure 14. Effect of Negative Offset (Single Supply)

This offset error, not the linearity error, produces this breakpoint. The transfer function would have followed the dotted line if the output buffer could drive below the ground rail.

For a DAC, linearity is measured between zero-input code (all inputs 0) and full-scale code (all inputs 1) after offset and full scale are adjusted out or accounted for in some way. However, single supply operation does not allow for adjustment when the offset is negative due to the breakpoint in the transfer function. So the linearity is measured between full-scale code and the lowest code that produces a positive output voltage.

DEFINITIONS OF SPECIFICATIONS AND TERMINOLOGY

Integral Nonlinearity (INL)

The relative accuracy or integral nonlinearity (INL), sometimes referred to as linearity error, is the maximum deviation of the output from the line between zero and full scale excluding the effects of zero code and full-scale errors.

Differential Nonlinearity (DNL)

The differential nonlinearity (DNL), sometimes referred to as differential error, is the difference between the measured and ideal 1 LSB amplitude change of any two adjacent codes. Monotonic means the output voltage changes in the same direction (or remains constant) as a change in the digital input code.

Zero-Scale Error (E_{ZS})

Zero-scale error is defined as the deviation of the output from 0 V at a digital input value of 0.

Gain Error (E_G)

Gain error is the error in slope of the DAC transfer function.

Total Harmonic Distortion (THD)

THD is the ratio of the rms value of the first six harmonic components to the value of the fundamental signal. The value for THD is expressed in decibels.

Signal-to-Noise Ratio + Distortion (S/N+D)

S/N+D is the ratio of the rms value of the output signal to the rms sum of all other spectral components below the Nyquist frequency, including harmonics but excluding dc. The value for S/N+D is expressed in decibels.

Spurious Free Dynamic Range (SFDR)

Spurious free dynamic range is the difference between the rms value of the output signal and the rms value of the largest spurious signal within a specified bandwidth. The value for SFDR is expressed in decibels.

JG (R-GDIP-T8)

CERAMIC DUAL-IN-LINE

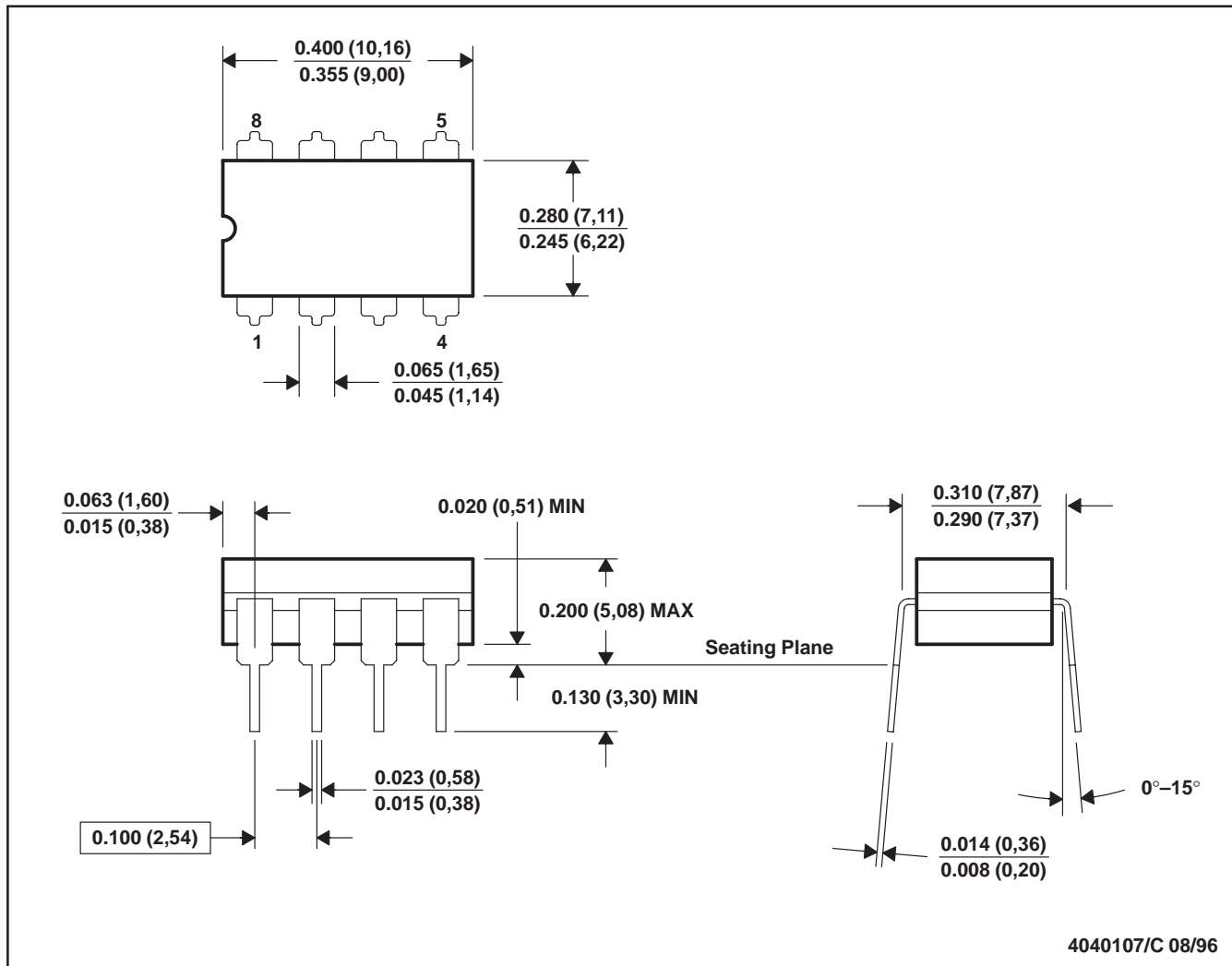

- NOTES: A. All linear dimensions are in inches (millimeters).
 B. This drawing is subject to change without notice.
 C. This package can be hermetically sealed with a ceramic lid using glass frit.
 D. Index point is provided on cap for terminal identification.
 E. Falls within MIL STD 1835 GDIP1-T8

FK (S-CQCC-N**)

LEADLESS CERAMIC CHIP CARRIER

28 TERMINAL SHOWN



4040140/D 10/96

- NOTES:
- A. All linear dimensions are in inches (millimeters).
 - B. This drawing is subject to change without notice.
 - C. This package can be hermetically sealed with a metal lid.
 - D. The terminals are gold plated.
 - E. Falls within JEDEC MS-004

D (R-PDSO-G**)

PLASTIC SMALL-OUTLINE PACKAGE

8 PINS SHOWN



- NOTES: A. All linear dimensions are in inches (millimeters).
 B. This drawing is subject to change without notice.
 C. Body dimensions do not include mold flash or protrusion, not to exceed 0.006 (0,15).
 D. Falls within JEDEC MS-012

IMPORTANT NOTICE

Texas Instruments Incorporated and its subsidiaries (TI) reserve the right to make corrections, modifications, enhancements, improvements, and other changes to its products and services at any time and to discontinue any product or service without notice. Customers should obtain the latest relevant information before placing orders and should verify that such information is current and complete. All products are sold subject to TI's terms and conditions of sale supplied at the time of order acknowledgment.

TI warrants performance of its hardware products to the specifications applicable at the time of sale in accordance with TI's standard warranty. Testing and other quality control techniques are used to the extent TI deems necessary to support this warranty. Except where mandated by government requirements, testing of all parameters of each product is not necessarily performed.

TI assumes no liability for applications assistance or customer product design. Customers are responsible for their products and applications using TI components. To minimize the risks associated with customer products and applications, customers should provide adequate design and operating safeguards.

TI does not warrant or represent that any license, either express or implied, is granted under any TI patent right, copyright, mask work right, or other TI intellectual property right relating to any combination, machine, or process in which TI products or services are used. Information published by TI regarding third-party products or services does not constitute a license from TI to use such products or services or a warranty or endorsement thereof. Use of such information may require a license from a third party under the patents or other intellectual property of the third party, or a license from TI under the patents or other intellectual property of TI.

Reproduction of information in TI data books or data sheets is permissible only if reproduction is without alteration and is accompanied by all associated warranties, conditions, limitations, and notices. Reproduction of this information with alteration is an unfair and deceptive business practice. TI is not responsible or liable for such altered documentation.

Resale of TI products or services with statements different from or beyond the parameters stated by TI for that product or service voids all express and any implied warranties for the associated TI product or service and is an unfair and deceptive business practice. TI is not responsible or liable for any such statements.

Following are URLs where you can obtain information on other Texas Instruments products and application solutions:

Products		Applications	
Amplifiers	amplifier.ti.com	Audio	www.ti.com/audio
Data Converters	dataconverter.ti.com	Automotive	www.ti.com/automotive
DSP	dsp.ti.com	Broadband	www.ti.com/broadband
Interface	interface.ti.com	Digital Control	www.ti.com/digitalcontrol
Logic	logic.ti.com	Military	www.ti.com/military
Power Mgmt	power.ti.com	Optical Networking	www.ti.com/opticalnetwork
Microcontrollers	microcontroller.ti.com	Security	www.ti.com/security
		Telephony	www.ti.com/telephony
		Video & Imaging	www.ti.com/video
		Wireless	www.ti.com/wireless

Mailing Address: Texas Instruments
Post Office Box 655303 Dallas, Texas 75265