

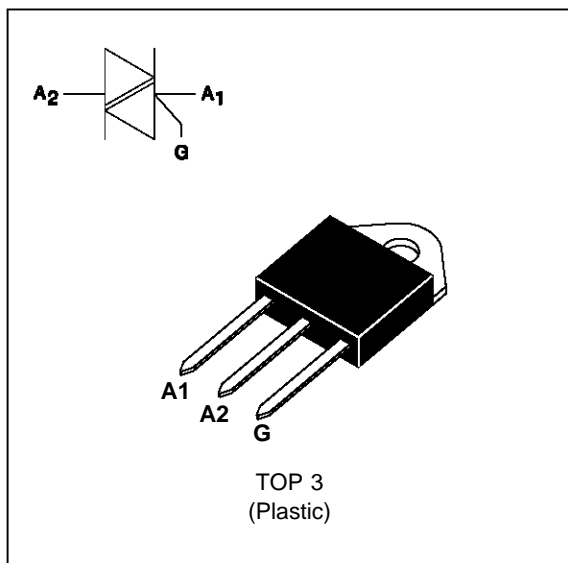
## ALTERNISTORS

### FEATURES

- HIGH COMMUTATION : > 88 A/ms (400Hz)
- INSULATING VOLTAGE = 2500V<sub>(RMS)</sub>  
(UL RECOGNIZED : EB81734)
- HIGH VOLTAGE CAPABILITY : V<sub>DRM</sub> = 1200 V

### DESCRIPTION

The TPDV 625 ---> 1225 use a high performance passivated glass alternistor technology. Featuring very high commutation levels and high surge current capability, this family is well adapted to power control on inductive load (motor, transformer...)



### ABSOLUTE RATINGS (limiting values)

Symbol	Parameter		Value	Unit
I <sub>T(RMS)</sub>	RMS on-state current (360° conduction angle)	T <sub>c</sub> = 85 °C	25	A
I <sub>TSM</sub>	Non repetitive surge peak on-state current ( T <sub>j</sub> initial = 25°C )	tp = 2.5 ms	390	A
		tp = 8.3 ms	250	
		tp = 10 ms	230	
I <sup>2</sup> t	I <sup>2</sup> t value	tp = 10 ms	265	A <sup>2</sup> s
di/dt	Critical rate of rise of on-state current Gate supply : I <sub>G</sub> = 500mA di <sub>G</sub> /dt = 1A/μs	Repetitive F = 50 Hz	20	A/μs
		Non Repetitive	100	
T <sub>stg</sub> T <sub>j</sub>	Storage and operating junction temperature range		- 40 to + 150 - 40 to + 125	°C °C
TI	Maximum lead temperature for soldering during 10 s at 4.5 mm from case		260	°C

Symbol	Parameter	TPDV				Unit
		625	825	1025	1225	
V <sub>DRM</sub> V <sub>R</sub> RM	Repetitive peak off-state voltage T <sub>j</sub> = 125 °C	600	800	1000	1200	V

**THERMAL RESISTANCES**

Symbol	Parameter	Value	Unit
Rth (j-a)	Contact to ambient	50	°C/W
Rth (j-c) DC	Junction to case for DC	1.5	°C/W
Rth (j-c) AC	Junction to case for 360° conduction angle ( F= 50 Hz)	1.1	°C/W

**GATE CHARACTERISTICS** (maximum values)

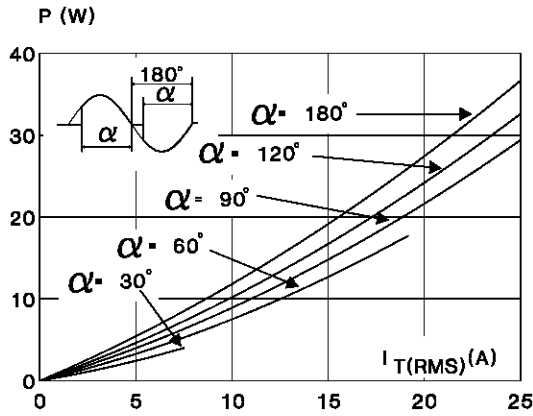
$P_G$  (AV) = 1W     $P_{GM}$  = 40W (tp = 20 μs)     $I_{GM}$  = 8A (tp = 20 μs)     $V_{GM}$  = 16V (tp = 20 μs).

**ELECTRICAL CHARACTERISTICS**

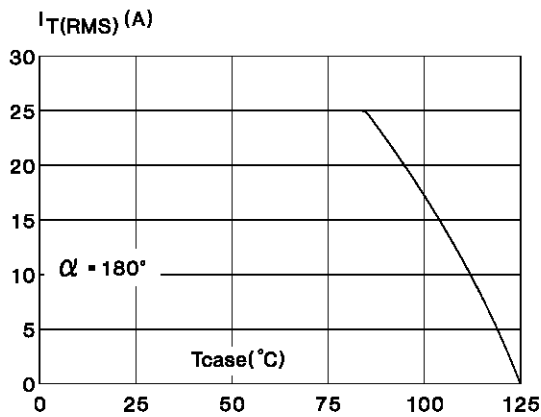
Symbol	Test Conditions	Quadrant		Value	Unit
$I_{GT}$	$V_D=12V$ (DC) $R_L=33\Omega$	$T_j=25^\circ C$	I-II-III	MAX	150 mA
$V_{GT}$	$V_D=12V$ (DC) $R_L=33\Omega$	$T_j=25^\circ C$	I-II-III	MAX	1.5 V
$V_{GD}$	$V_D=V_{DRM}$ $R_L=3.3k\Omega$	$T_j=125^\circ C$	I-II-III	MIN	0.2 V
tgt	$V_D=V_{DRM}$ $I_G = 500mA$ $di_G/dt = 3A/\mu s$	$T_j=25^\circ C$	I-II-III	TYP	2.5 μs
$I_L$	$I_G=1.2 I_{GT}$	$T_j=25^\circ C$	I-III	TYP	100 mA
			II		200 mA
$I_H$ *	$I_T= 500mA$ gate open	$T_j=25^\circ C$		TYP	50 mA
$V_{TM}$ *	$I_{TM}= 35A$ tp= 380μs	$T_j=25^\circ C$		MAX	1.8 V
$I_{DRM}$ $I_{RRM}$	$V_{DRM}$ Rated $V_{RRM}$ Rated	$T_j=25^\circ C$		MAX	0.02 mA
		$T_j=125^\circ C$		MAX	8 mA
dV/dt *	Linear slope up to $V_D=67\%V_{DRM}$ gate open	$T_j=125^\circ C$		MIN	500 V/μs
(di/dt)c *	(dV/dt)c = 200V/μs	$T_j=125^\circ C$		MIN	20 A/ms
	(dV/dt)c = 10V/μs				88 A/ms

\* For either polarity of electrode A<sub>2</sub> voltage with reference to electrode A<sub>1</sub>.

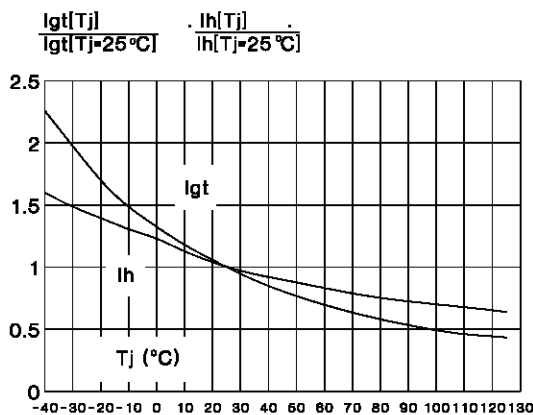
**Fig.1 :** Maximum RMS power dissipation versus RMS on-state current (F=50Hz).  
(Curves are cut off by (di/dt)c limitation)



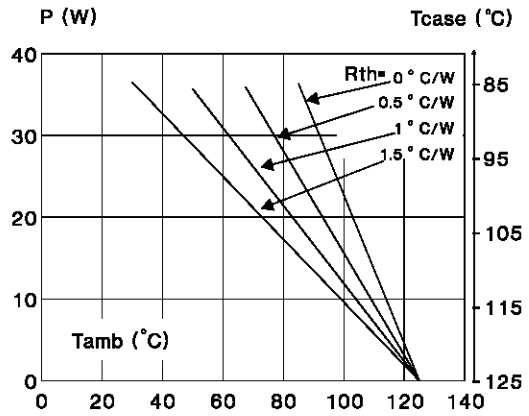
**Fig.3 :** RMS on-state current versus case temperature.



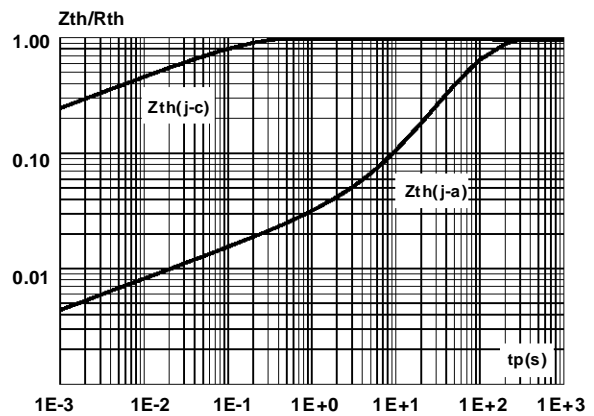
**Fig.5 :** Relative variation of gate trigger current and holding current versus junction temperature.



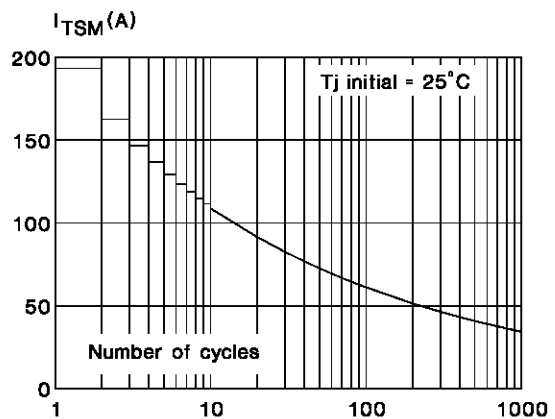
**Fig.2 :** Correlation between maximum RMS power dissipation and maximum allowable temperatures (Tamb and Tcase) for different thermal resistances heatsink + contact.



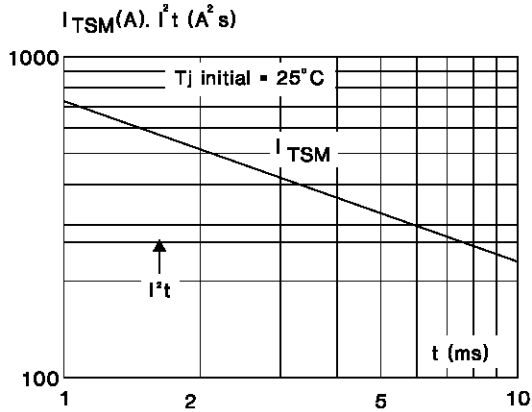
**Fig.4 :** Relative variation of thermal impedance versus pulse duration.



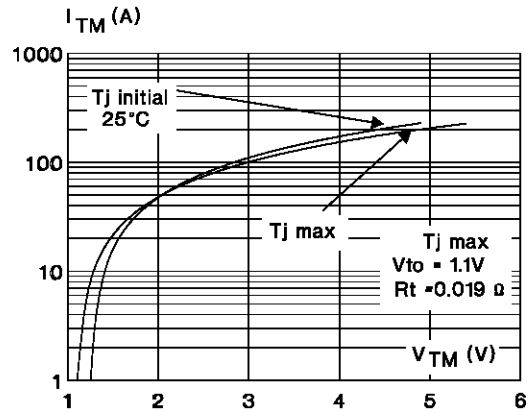
**Fig.6 :** Non Repetitive surge peak on-state current versus number of cycles.



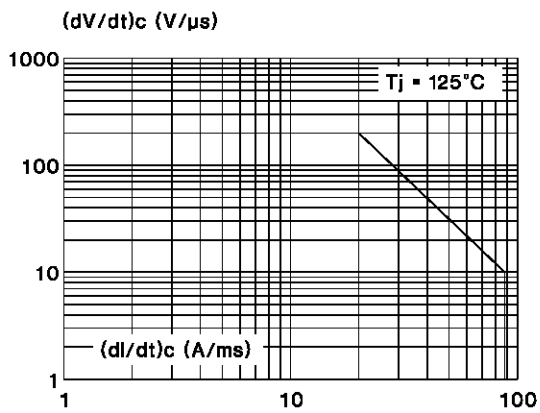
**Fig.7 :** Non repetitive surge peak on-state current for a sinusoidal pulse with width :  $t \leq 10\text{ms}$ , and corresponding value of  $I^2t$ .



**Fig.8 :** On-state characteristics (maximum values).

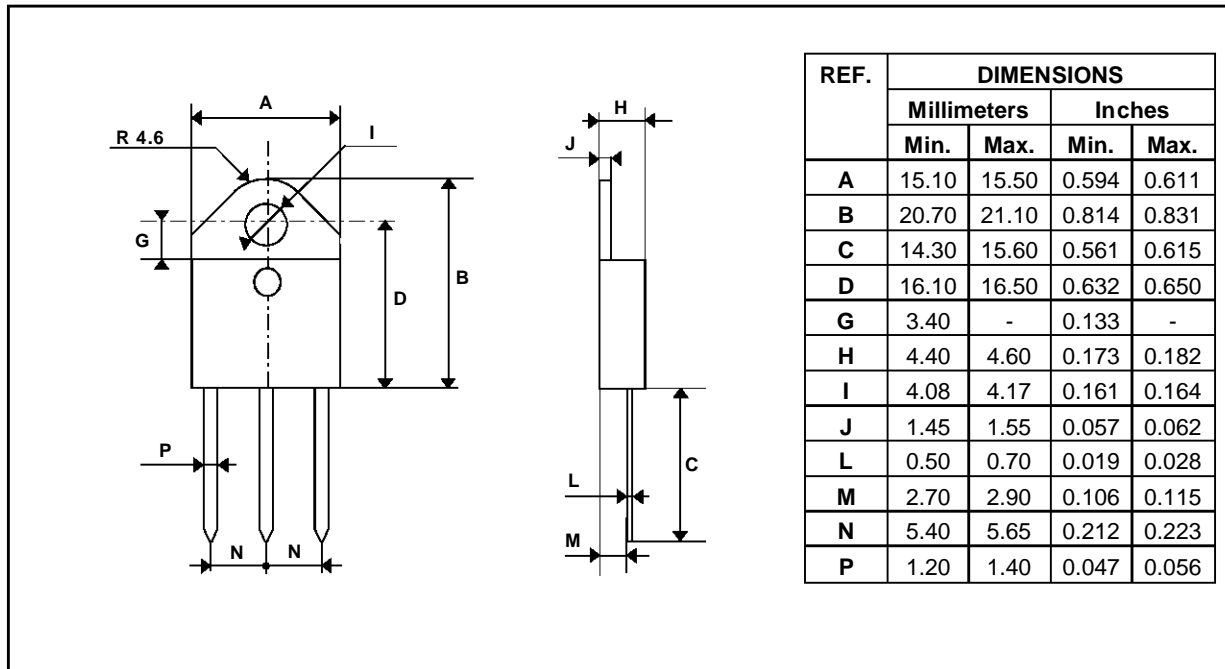


**Fig.9 :** Safe operating area.



**PACKAGE MECHANICAL DATA**

TOP 3 Plastic



Cooling method : C

Marking : type number

Weight : 4.7 g

Recommended torque value : 0.8 m.N.

Maximum torque value : 1 m.N.

Information furnished is believed to be accurate and reliable. However, SGS-THOMSON Microelectronics assumes no responsibility for the consequences of use of such information nor for any infringement of patents or other rights of third parties which may result from its use. No license is granted by implication or otherwise under any patent or patent rights of SGS-THOMSON Microelectronics. Specifications mentioned in this publication are subject to change without notice. This publication supersedes and replaces all information previously supplied.

SGS-THOMSON Microelectronics products are not authorized for use as critical components in life support devices or systems without express written approval of SGS-THOMSON Microelectronics.

© 1995 SGS-THOMSON Microelectronics - Printed in Italy - All rights reserved.

SGS-THOMSON Microelectronics GROUP OF COMPANIES

Australia - Brazil - France - Germany - Hong Kong - Italy - Japan - Korea - Malaysia - Malta - Morocco - The Netherlands - Singapore - Spain - Sweden - Switzerland - Taiwan - Thailand - United Kingdom - U.S.A.