

# TRD

## TRDT with TV-5 Approval

### MAIN FEATURES

- Switching capacity available by 12A in spite of small size design for high density P.C. board mounting technique.
- UL/CSA recognized. TRDT (TV-5 Approval).
- Selection of plastic material for high temperature and better chemical solution performance.
- Sealed types available.
- Simple relay magnetic circuit to meet low cost of mass production.



### APPLICATIONS

- TRD : • Domestic appliance, office machine, audio, equipment, automobile, etc.  
 TRDT : • Remote control TV receiver, monitor display, audio equipment high rushing current use application.

### ORDERING INFORMATION

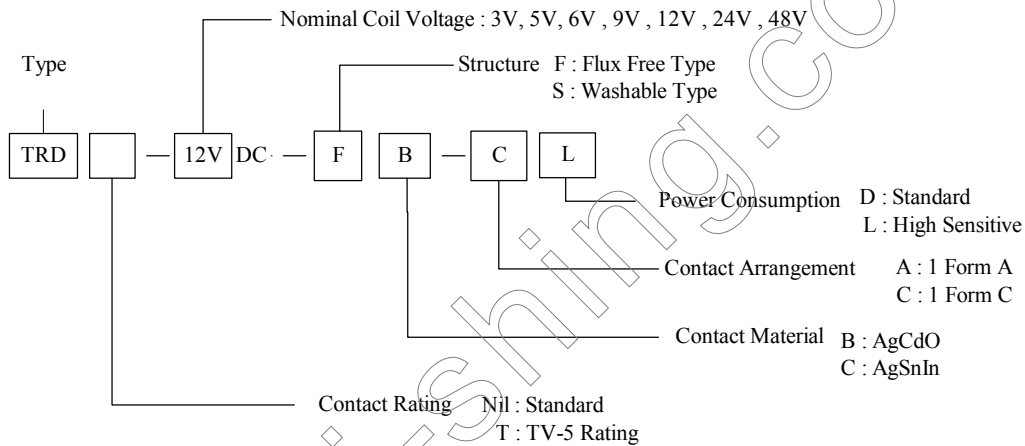

### DIMENSION (unit:mm)

### DRILLING (unit:mm)

### WIRING DIAGRAM

TRD 1 Form A AND TRDT(TV-5)

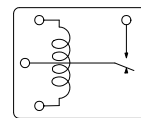
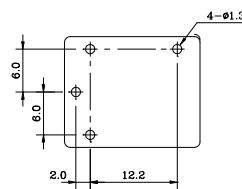
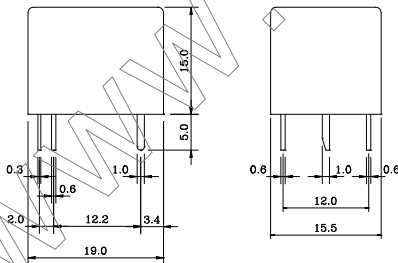

TRD 1 Form C

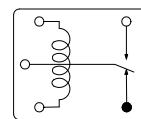
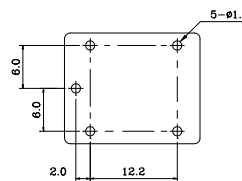
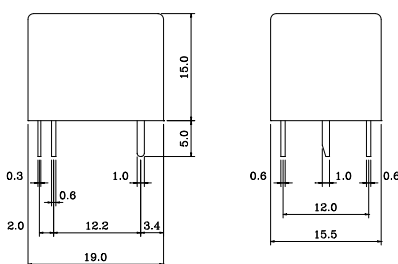

## COIL DATA CHART (AT20°C)

| Coil Sensitivity          | Coil Voltage Code | Nominal Voltage (VDC) | Nominal Current (mA) | Coil Resistance ( $\Omega$ ) $\pm 10\%$ | Power Consumption (W) | Pull-In Voltage (VDC) | Drop-Out Voltage (VDC) | Max-Allowable Voltage (VDC) |
|---------------------------|-------------------|-----------------------|----------------------|---|-----------------------|-----------------------|------------------------|-----------------------------|
| TRD<br>(High Sensitivity) | 03                | 03                    | 120                  | 25                                      | abt. 0.36W            | 75% Max.              | 5% Min.                | 120%                        |
|                           | 05                | 05                    | 71.4                 | 70                                      |                       |                       |                        |                             |
|                           | 06                | 06                    | 60                   | 100                                     |                       |                       |                        |                             |
|                           | 09                | 09                    | 40                   | 225                                     |                       |                       |                        |                             |
|                           | 12                | 12                    | 30                   | 400                                     |                       |                       |                        |                             |
|                           | 24                | 24                    | 15                   | 1600                                    |                       |                       |                        |                             |
| TRD<br>(Standard)         | 03                | 03                    | 150                  | 20                                      | abt. 0.45W            | 75% Max.              | 5% Min.                | 110%                        |
|                           | 05                | 05                    | 89.3                 | 55                                      |                       |                       |                        |                             |
|                           | 06                | 06                    | 75                   | 80                                      |                       |                       |                        |                             |
|                           | 09                | 09                    | 50                   | 180                                     |                       |                       |                        |                             |
|                           | 12                | 12                    | 37.5                 | 320                                     |                       |                       |                        |                             |
|                           | 24                | 24                    | 18.7                 | 1280                                    |                       |                       |                        |                             |
|                           | 48                | 48                    | 10                   | 4500                                    | abt. 0.51W            |                       |                        |                             |

## CONTACT RATING

| Item  | Type | TRD                      |                          | TRDT  |
|---|------|--------------------------|--------------------------|---|
|   |      | 12A                      | 15A                      |   |
| Contact Capacity                              |      | 12A 28VDC                | 12A 28VDC                | 15A 28VDC   |
| Resistive Load<br>( $\cos\Phi=1$ )            |      | 12A 120VAC<br>10A 250VAC | 15A 125VAC<br>10A 250VAC | 15A 125VAC<br>10A 250VAC                                |
| Inductive Load<br>( $\cos\Phi=0.4$ L/R=7msec) |      | 4A 120VAC<br>4A 28VDC    | 7A 120VAC<br>7A 28VDC    | 120VAC TV-5<br>Incandescent Lamp 5A<br>Rush Current 80A |
| Rated Carrying Current                        |      | 12A                      | 15A                      | 15A   |
| Max. Allowable Voltage                        |      | 250VAC/110VDC            | 250VAC/110VDC            | 250VAC/110VDC   |
| Max. Allowable Current                        |      | 12A                      | 15A                      | 15A   |
| Max. Allowable Power Force                    |      | 1200VAC/240W             | 600VA, 300W              | 600VA, 300W   |
| Referenced Min.<br>Applicable Load            |      | 5VDC, 10mA               | 5VDC, 10mA               | 10VDC, 10mA   |
| Contact Material                              |      | Ag Alloy                 | Ag Alloy                 | Ag Alloy  |

## REFERENCE DATA

Coil Temperature Rise

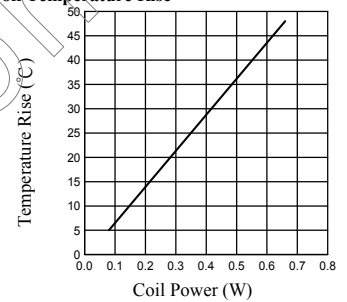

Operation Time

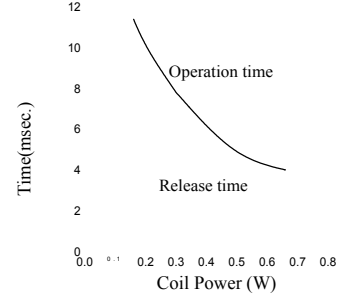

Life Expectancy

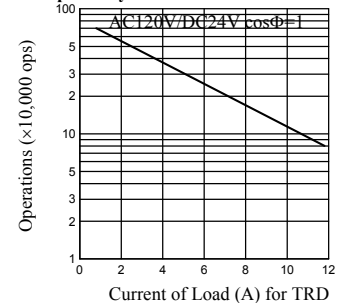

Life Expectancy

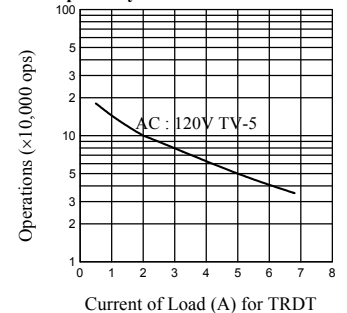

## PERFORMANCE (at initial value)

| Item                          | Type | TRD  |
|-------------------------------|------|--|
| Contact Resistance            |      | 100m $\Omega$ Max.   |
| Operation Time                |      | 10msec Max.  |
| Release Time                  |      | 5msec Max.   |
| Dielectric Strength           |      |  |
| Between coil & contact        |      | 1000VAC 50/60HZ (1 minute)   |
| Between contacts              |      | 500VAC 50/60HZ (1 minute)  |
| Surge Resistiveness           |      | 3000V (between coil & contact 1 $\times$ 40 usec)                    |
| Insulation Resistance         |      | 100 M $\Omega$ Min. (500VDC)   |
| Max. ON/OFF Switching         |      |  |
| Mechanically                  |      | 300 operation/min  |
| Electrically                  |      | 30 operation/min   |
| Operating Ambient Temperature |      | -30°C to +80°C<br>(No water condensation and no water drop)          |
| Operating Humidity            |      | 45 to 85% RH   |
| Coil Temperature Rise         |      | 35 deg. Max.   |
| Vibration                     |      |  |
| Endurance                     |      | 10 to 55Hz Double Amplitude 1.5mm                                    |
| Error Operation               |      | 10 to 55Hz Double Amplitude 1.5mm                                    |
| Shock                         |      |  |
| Endurance                     |      | 100G Min.  |
| Error Operation               |      | 10G Min.   |
| Life Expectancy               |      |  |
| Mechanically                  |      | 10 $\times$ 10 <sup>6</sup> operations. Min. (no load)               |
| Electrically                  |      | 10 $\times$ 10 <sup>4</sup> operations. Min. (at rated coil voltage) |
| Weight                        |      | abt. 10grs.  |
| UL File No.                   |      | E156521 (TV-5)   |
| CSA File No.                  |      | LR102317   |
| TUV File No.                  |      | R9653009   |